





AX-596

STEREO AMPLIFIER

AMPLIFICATEUR STEREO

OWNER'S MANUAL

	CAUTION RISK OF ELECTRIC SHOCK DO NOT OPEN	
CAUTION: TO REDUCE THE RISK OF ELECTRIC SHOCK, DO NOT REMOVE COVER (OR BACK). NO USER-SERVICEABLE PARTS INSIDE. REFER SERVICING TO QUALIFIED SERVICE PERSONNEL.		

IMPORTANT
Please record the serial number of this system in the space below.

Model:

Serial No.:

The serial number is located on the rear of the main unit.
Retain this Owner's Manual in a safe place for future reference.

• Explanation of Graphical Symbols

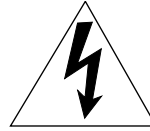

The lightning flash with arrowhead symbol, within an equilateral triangle, is intended to alert you to the presence of uninsulated "dangerous voltage" within the product's enclosure that may be of sufficient magnitude to constitute a risk of electric shock to persons.



The exclamation point within an equilateral triangle is intended to alert you to the presence of important operating and maintenance (servicing) instructions in the literature accompanying the appliance.

WARNING
TO REDUCE THE RISK OF FIRE OR ELECTRIC SHOCK, DO NOT EXPOSE THIS APPLIANCE TO RAIN OR MOISTURE.

SAFETY INSTRUCTIONS

- 1 Read Instructions – All the safety and operating instructions should be read before the unit is operated.
- 2 Retain Instructions – The safety and operating instructions should be retained for future reference.
- 3 Heed Warnings – All warnings on the unit and in the operating instructions should be adhered to.
- 4 Follow Instructions – All operating and other instructions should be followed.
- 5 Water and Moisture – The unit should not be used near water – for example, near a bathtub, washbowl, kitchen sink, laundry tub, in a wet basement, or near a swimming pool, etc.
- 6 Carts and Stands – The unit should be used only with a cart or stand that is recommended by the manufacturer.
- 6A A unit and cart combination should be moved with care. Quick stops, excessive force, and uneven surfaces may cause the unit and cart combination to overturn. 
- 7 Wall or Ceiling Mounting – The unit should be mounted to a wall or ceiling only as recommended by the manufacturer.
- 8 Ventilation – The unit should be situated so that its location or position does not interfere with its proper ventilation. For example, the unit should not be situated on a bed, sofa, rug, or similar surface, that may block the ventilation openings; or placed in a built-in installation, such as a bookcase or cabinet that may impede the flow of air through the ventilation openings.
- 9 Heat – The unit should be situated away from heat sources such as radiators, stoves, or other appliances that produce heat.
- 10 Power Sources – The unit should be connected to a power supply only of the type described in the operating instructions or as marked on the unit.
- 11 Power-Cord Protection – Power-supply cords should be routed so that they are not likely to be walked on or pinched by items placed upon or against them, paying particular attention to cords at plugs, convenience receptacles, and the point where they exit from the unit.
- 12 Cleaning – The unit should be cleaned only as recommended by the manufacturer.
- 13 Nonuse Periods – The power cord of the unit should be unplugged from the outlet when left unused for a long period of time.
- 14 Object and Liquid Entry – Care should be taken so that objects do not fall into and liquids are not spilled into the inside of the unit.
- 15 Damage Requiring Service – The unit should be serviced by qualified service personnel when:
 - A. The power-supply cord or the plug has been damaged; or
 - B. Objects have fallen, or liquid has been spilled into the unit; or
 - C. The unit has been exposed to rain; or
 - D. The unit does not appear to operate normally or exhibits a marked change in performance; or
 - E. The unit has been dropped, or the cabinet damaged.
- 16 Servicing – The user should not attempt to service the unit beyond those means described in the operating instructions. All other servicing should be referred to qualified service personnel.
- 17 Power Lines – An outdoor antenna should be located away from power lines.
- 18 Grounding or Polarization – Precautions should be taken so that the grounding or polarization is not defeated.

FCC INFORMATION (for US customers only)

1. IMPORTANT NOTICE : DO NOT MODIFY THIS UNIT!

This product, when installed as indicated in the instructions contained in this manual, meets FCC requirements. Modifications not expressly approved by Yamaha may void your authority, granted by the FCC, to use the product.

2. IMPORTANT : When connecting this product to accessories and/or another product use only high quality shielded cables. Cable/s supplied with this product **MUST** be used. Follow all installation instructions. Failure to follow instructions could void your FCC authorization to use this product in the USA.

3. NOTE : This product has been tested and found to comply with the requirements listed in FCC Regulations, Part 15 for Class "B" digital devices. Compliance with these requirements provides a reasonable level of assurance that your use of this product in a residential environment will not result in harmful interference with other electronic devices.

This equipment generates/uses radio frequencies and, if not installed and used according to the instructions found in the users manual, may cause interference harmful to the operation of other electronic devices.

Compliance with FCC regulations does not guarantee that interference will not occur in all installations. If this product is found to be the source of interference, which can be determined by turning the unit "OFF" and "ON", please try to eliminate the problem by using one of the following measures:

Relocate either this product or the device that is being affected by the interference.

Utilize power outlets that are on different branch (circuit breaker or fuse) circuits or install AC line filter/s.

In the case of radio or TV interference, relocate/reorient the antenna. If the antenna lead-in is 300 ohm ribbon lead, change the lead-in to coaxial type cable.

If these corrective measures do not produce satisfactory results, please contact the local retailer authorized to distribute this type of product. If you can not locate the appropriate retailer, please contact Yamaha Electronics Corp., U.S.A. 6660 Orangethorpe Ave, Buena Park, CA 90620.

The above statements apply **ONLY** to those products distributed by Yamaha Corporation of America or its subsidiaries.

We Want You Listening For A Lifetime

YAMAHA and the Electronic Industries Association's Consumer Electronics Group want you to get the most out of your equipment by playing it at a safe level. One that lets the sound come through loud and clear without annoying blaring or distortion – and, most importantly, without affecting your sensitive hearing.

Since hearing damage from loud sounds is often undetectable until it is too late, YAMAHA and the Electronic Industries Association's Consumer Electronics Group recommend you to avoid prolonged exposure from excessive volume levels.



UNPACKING DEBALLAGE

After unpacking, check that the following items are contained.

Après le déballage, vérifier que les pièces suivantes sont incluses.

- Remote control
- Télécommande



- Batteries (size AA, R6, UM-3)
- Piles (format AA, R6, UM-3)

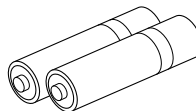

Opening and closing the front cover

Close the front cover whenever the controls inside the panel are not used.

Ouverture et fermeture du couvercle avant

Fermer le couvercle avant lorsque les commandes placées à l'intérieur du panneau ne sont pas utilisées.

To open the front cover
Pour ouvrir le couvercle avant

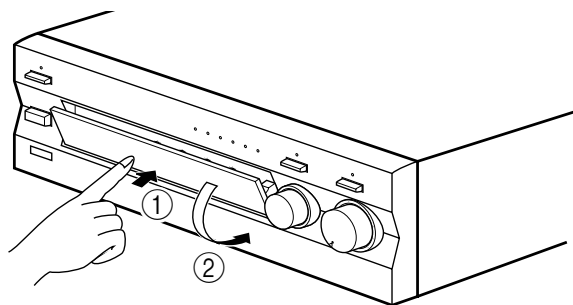

To close the front cover
Pour fermer le couvercle avant

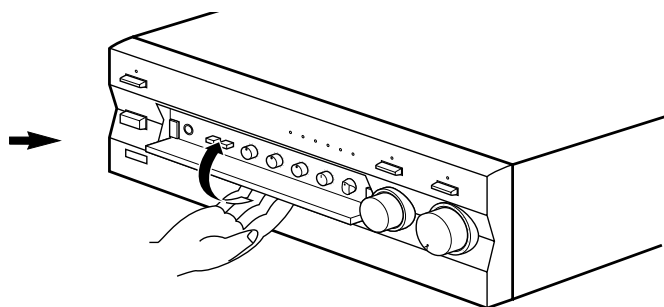

FEATURES

- 100W + 100W (8Ω) RMS Output Power, 0.015% THD, 20–20,000 Hz
- Highly Dynamic Power, Low Impedance Drive Capability
- Continuously Variable LOUDNESS Control
- CD/DVD DIRECT AMP Switch Used to Reproduce the Purest CD and DVD Sound
- PURE DIRECT Switch Used to Reproduce the Purest Source Sound
- REC OUT Selector Independent of Input Source Selection
- PRE OUT/MAIN IN Terminals for Connecting An Equalizer, Surround-Sound Processor, etc.
- Remote Control Capability

CONTENTS

SAFETY INSTRUCTIONS	II
UNPACKING	IV
FEATURES	1
CAUTION	2
NOTES ABOUT THE REMOTE CONTROL	3
CONTROLS AND THEIR FUNCTIONS	4
CONNECTIONS.....	7
OPERATION	10
TROUBLESHOOTING	13
SPECIFICATIONS.....	14

CAUTION: Read this before operating your unit.

1. To assure the finest performance, please read this manual carefully. Keep it in a safe place for future reference.
2. Install this unit in a cool, dry, clean place – away from windows, heat sources, sources of excessive vibration, dust, moisture and cold. Avoid sources of humming (transformers, motors). To prevent fire or electrical shock, do not expose the unit to rain or water.
3. Never open the cabinet. If something drops into the set, contact your dealer.
4. Do not use force on switches, controls or connection wires. When moving the unit, first disconnect the power plug and the wires connected to other equipments. Never pull the wires themselves.
5. The openings on the unit cover assure proper ventilation of the unit. If these openings are obstructed, the temperature inside the unit will rise rapidly; therefore, avoid placing objects against these openings. Install the unit in a well-ventilated area to prevent fire or damage.
<Europe, U.K. and China models only>
Be sure to allow a space of at least 20 cm behind, 20 cm on both sides and 30 cm above the top panel of the unit to prevent fire or damage.
6. The voltage used must be the same as that specified on this unit. Using this unit with a higher voltage than specified is dangerous and may result in fire or other accidents. YAMAHA will not be held responsible for any damage resulting from use of this unit with a voltage other than specified.
7. Always set the VOLUME control to “∞” before starting the audio source play. Increase the volume gradually to an appropriate level after the play has been started.
8. Do not attempt to clean the unit with chemical solvents as this might damage the finish. Use a clean, dry cloth.
9. Be sure to read the “TROUBLESHOOTING” section regarding common operating errors before concluding that the unit is faulty.
10. When not planning to use this unit for a long period (ie., vacation, etc.), disconnect the AC power plug from the wall outlet.
11. To prevent lightning damage, disconnect the AC power plug when there is an electric storm.
12. Grounding or polarization – Precautions should be taken so that the grounding or polarization of an appliance is not defeated.

13. Do not connect any audio equipment to the AC outlet on the rear panel if the equipment requires more power than the outlet is rated to provide.

14. VOLTAGE SELECTOR

(China and General models only)

The voltage selector on the rear panel of this unit must be set for your local main voltage BEFORE plugging into the AC main supply.

Voltages are 110/120/220/240 V AC, 50/60 Hz.

When this unit is turned off by pressing the STANDBY/ON switch on the front panel or the remote control, the STANDBY indicator on the front panel lights up. This state is called the standby mode. In this mode, this unit is designed to consume a small amount of power. This unit's power supply is completely cut off from the AC line only when the POWER switch on the front panel is set in the OFF position or the AC power cord is disconnected.

For Canadian Customers

To prevent electric shock, match wide blade of plug to wide slot and fully insert.

This Class B digital apparatus complies with Canadian ICES-003.

WARNING

Do not change the IMPEDANCE SELECTOR switch setting while the power to this unit is on, otherwise this unit may be damaged.

If this unit fails to turn on when the **POWER** switch is pressed:

The **IMPEDANCE SELECTOR** switch may not be set to either end. If so, set the switch to either end when this unit's power supply is completely cut off.

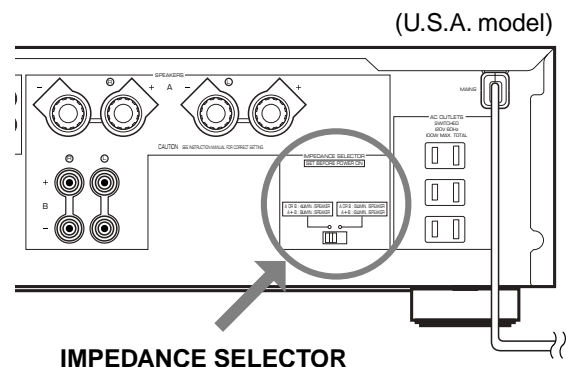

NOTES ABOUT THE REMOTE CONTROL

Battery installation

Since the remote control will be used for many of this unit's control operations, you should begin by installing the supplied batteries.

1. Turn the remote control over and remove the battery compartment cover by sliding it in the direction of the arrow.
2. Insert the batteries (AA, R6, UM-3 type) according to the polarity markings on the inside of the battery compartment.
3. Close the battery compartment cover.

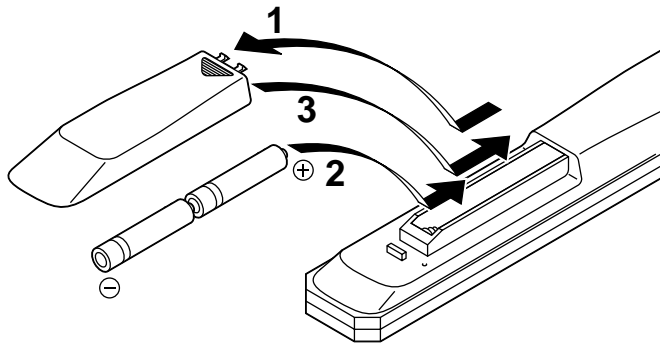

Battery replacement

If you notice that the remote control must be used closer to the main unit, the batteries are weak. Replace both batteries with new ones.

Notes

- Use AA, R6, UM-3 batteries.
- Be sure the polarities are correct. (See the illustration inside the battery compartment.)
- Remove the batteries if the remote control is not used for an extended period of time.
- If batteries leak, dispose of them immediately. Avoid touching the leaked material and contact with clothing, etc. Clean the battery compartment thoroughly before installing new batteries.

Remote control operation range

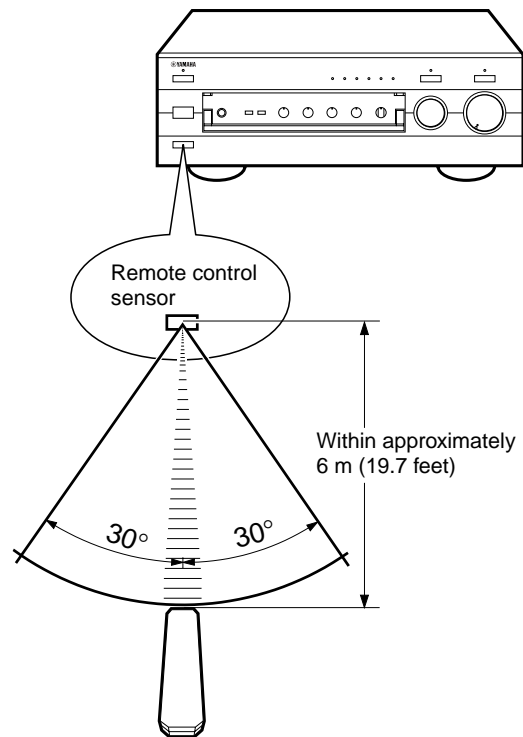

Notes

- The area between the remote control and the main unit must be clear of large obstacles.
- Do not expose the remote control sensor to strong lighting, in particular, an inverter type fluorescent lamp; otherwise, the remote control may not work properly. If necessary, position the main unit away from direct lighting.

CONTROLS AND THEIR FUNCTIONS

FRONT PANEL

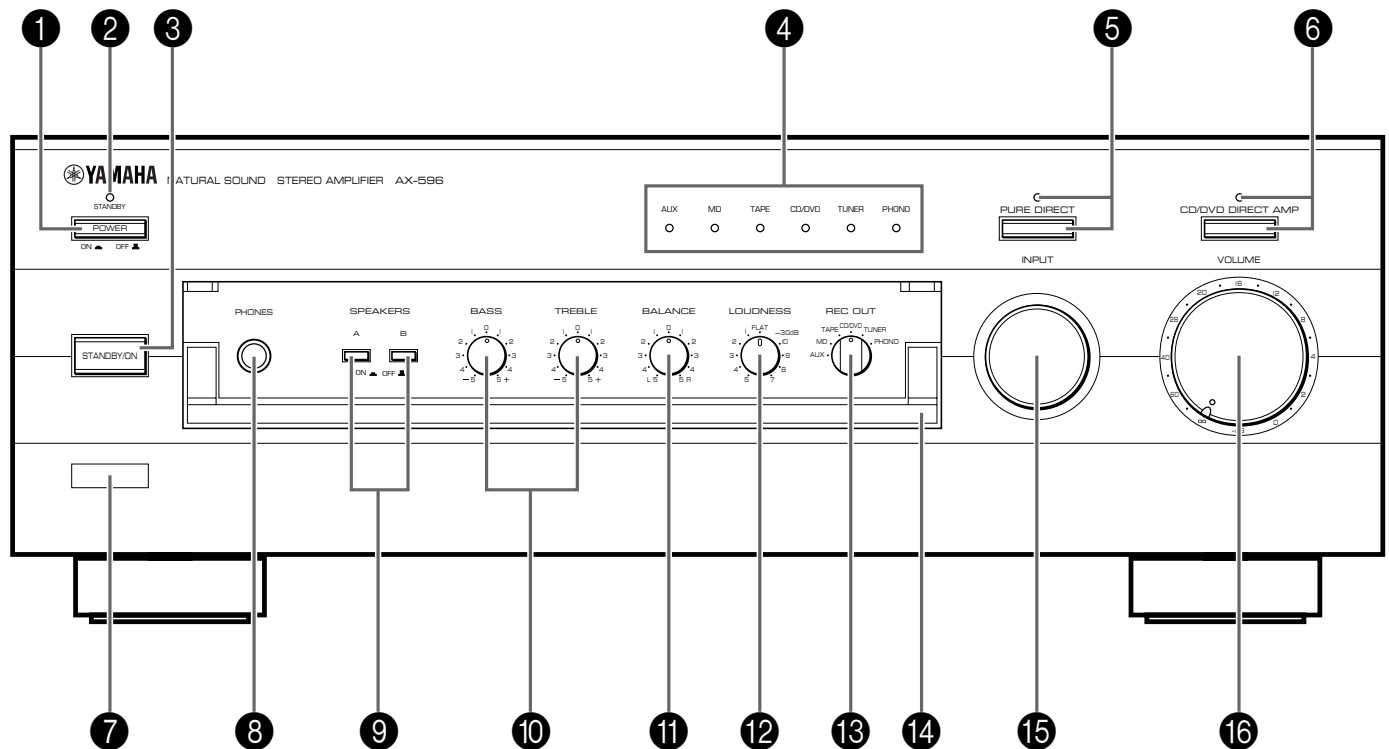

- 1 POWER**
Press this switch inward (ON) to use this unit. In this state, you can turn on this unit or turn this unit in the standby mode by pressing **STANDBY/ON**. Press this switch to release it outward (OFF) to completely cut off this unit's power supply from the AC line.
- 2 STANDBY indicator**
Lights up only while this unit is in the standby mode.
- 3 STANDBY/ON**
Press this switch to turn on the power. Press again to set this unit in the standby mode.
* This switch can be used only when **POWER** is set in the ON position.

Standby mode
This unit is still using a small amount of power in this mode in order to be ready to receive infrared-signals from the remote control.

- 4 Input source indicators**
The indicator of the currently selected input source lights up.
- 5 PURE DIRECT and indicator**
Press this switch, and the indicator above it lights up. You can listen to a source in the purest sound with this function. (Refer to page 12 for details.)
Press this switch again to cancel this function.
- 6 CD/DVD DIRECT AMP and indicator**
Press this switch, and the indicator above it lights up. You can listen to a CD or DVD source in the purest sound with this function. (Refer to page 12 for details.)
Press this switch again to cancel this function.
- 7 Remote control sensor**
Receives signals from the remote control.

8 PHONES jack

When you listen with headphones, connect the headphones to the **PHONES** jack and set both **SPEAKERS A** and **B** switches to the OFF position.

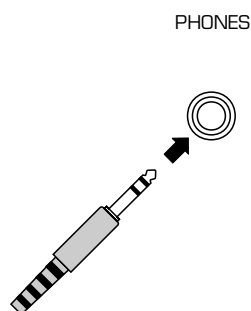

9 SPEAKERS

Press the switch **A** or **B** (or both) inward (ON) for the speakers you will use. Press and release the switch outward (OFF) for the speakers you do not use.

10 Tone controls

BASS

Rotate this knob to increase or decrease the low frequency response. The 0 position produces a flat response.

TREBLE

Rotate this knob to increase or decrease the high frequency response. The 0 position produces a flat response.

11 BALANCE

The balance of the output volume to the left and right speakers can be adjusted to compensate for sound imbalances caused by the speaker location or listening room conditions.

12 LOUDNESS

Used to compensate for the human ears' loss of sensitivity to high and low-frequency ranges at low volume. (Refer to page 12 for details.)

13 REC OUT selector

Rotate this knob to select the source for recording to an MD recorder or tape deck. This setting is independent of the **INPUT** selector setting, so this function allows you to record the selected source while listening to another source.

14 Front cover

Refer to inside of the front cover on how to open and close the front cover.

15 INPUT selector

Turn this knob to select the input source. The selected source will be shown by the lighting of corresponding input source indicator.

16 VOLUME

Turn this knob to raise or lower the volume level. (The REC OUT level is not affected.)

REMOTE CONTROL

The remote control is designed to control the most commonly used functions of the main unit. If you have a YAMAHA CD player, tuner, tape deck, etc. with remote control compatibility, this remote control will also control their various functions.

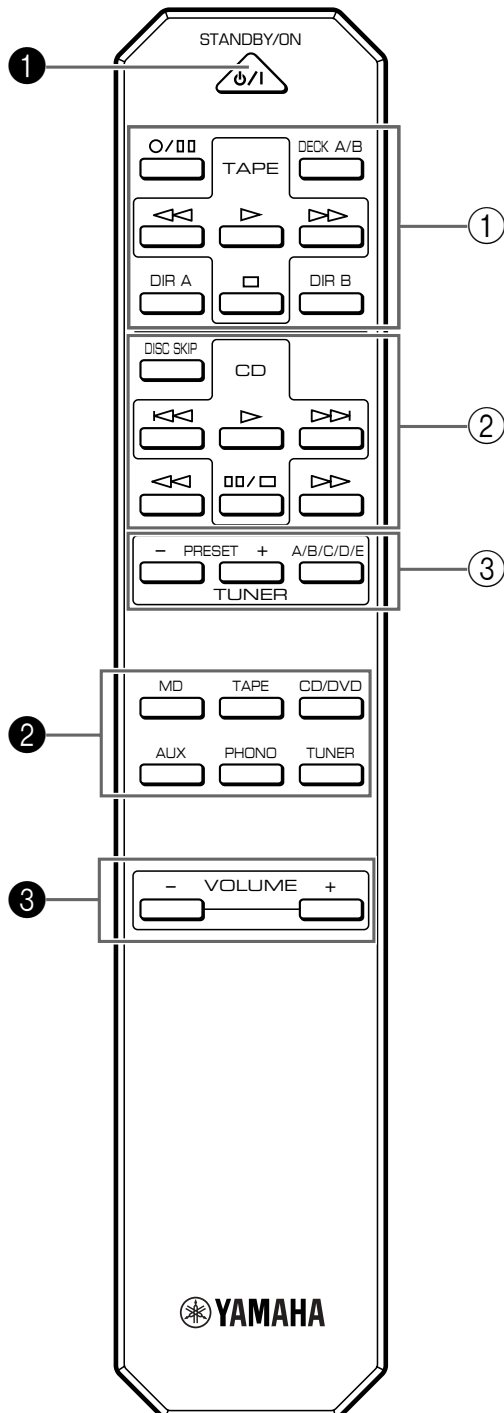

For Control of This Unit

① STANDBY/ON

Press this key to turn on this unit or turn it into the standby mode.

This key can be used only when the **POWER** switch on the main unit is set in the ON position.

Standby mode

In this state, this unit consumes a very small quantity of power to receive infrared-signals from the remote control.

② Input selector keys

Press a key to select the input source.

③ VOLUME +/-

Press these keys to increase or decrease the volume.

For Control of Other Components

Note

The functions of the keys to control other YAMAHA components are the same as the corresponding keys on those components. Refer to those components' instruction manuals for details.

① Tape deck keys

These keys control tape decks.

* **DIR A, B** and **A/B** apply only to double cassette tape decks.

* Pressing **DIR A** will reverse the tape direction on a single cassette tape deck with the automatic reverse function.

② CD player keys

These keys control compact disc players.

* **DISC SKIP** is used for disc changers only.

③ Tuner keys

These keys control tuners.

PRESET +: Press this key to select the next preset station number.

PRESET -: Press this key to select the previous preset station number.

A/B/C/D/E: Press this key to select the group (A – E) of preset station numbers.

CONNECTIONS

Caution: Plug in this unit and other components after all connections are completed.

- All connections must be correct, that is to say L (left) to L, R (right) to R, “+” to “+” and “-” to “-”. Also refer to the owner’s manual for each of your components.
- Use RCA type pin plug cables for audio/video units except speakers.
- The output (or input) terminals of YAMAHA audio/video units numbered 1, 2, 3, 4, etc. on the rear panel must be connected to the same-numbered terminals of this unit.

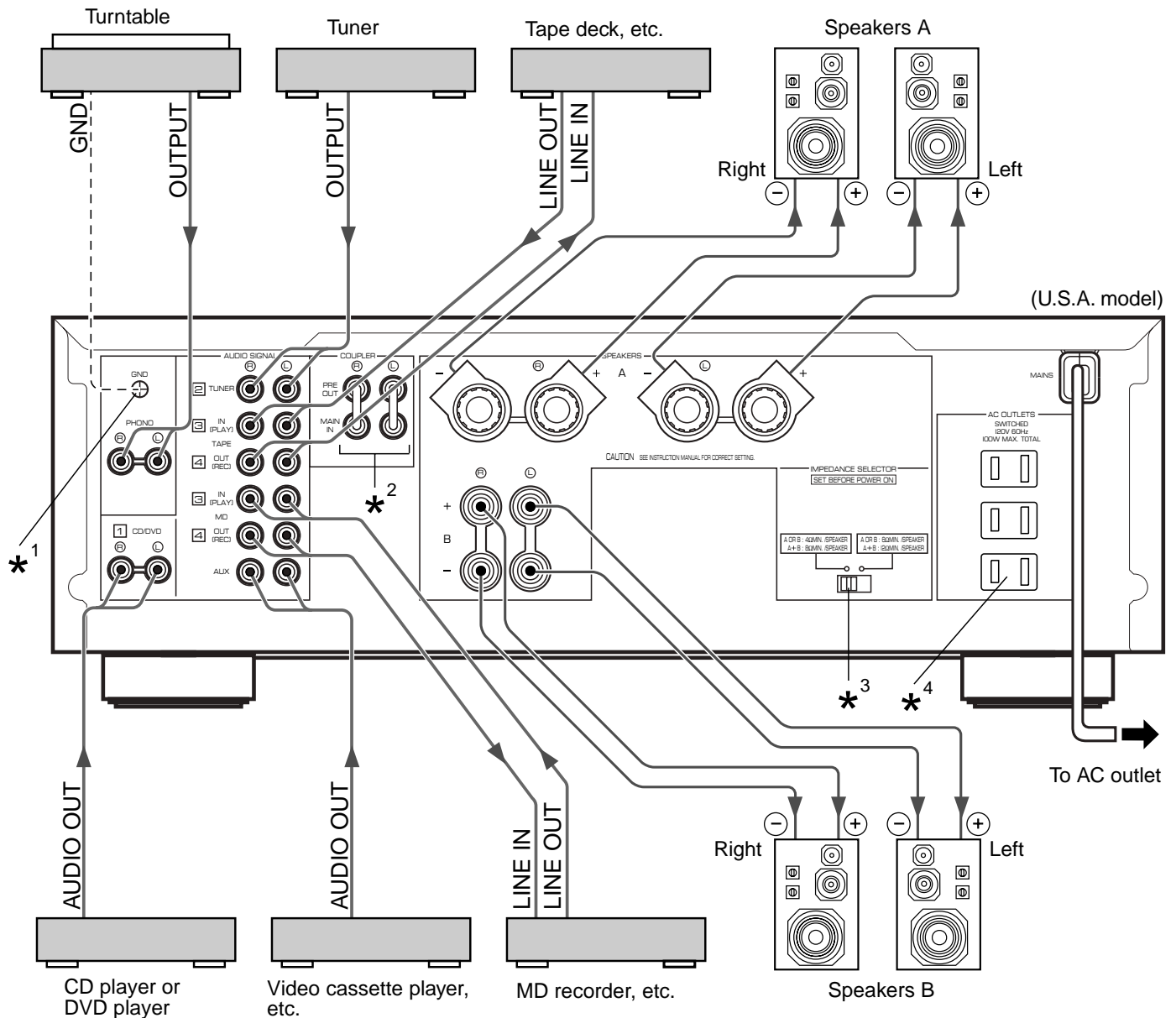

*¹, *², *³, *⁴: Refer to page 9 for descriptions.

→ : Indicates the direction of signals.

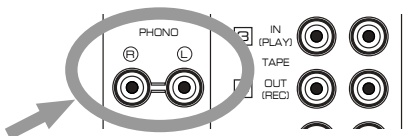

Note
These terminals are for connecting a turntable with an MM or high output MC cartridge. If you have a turntable with a low output MC cartridge, use an inline boosting transformer or MC-head amplifier when connecting to these terminals.

■ Connecting speakers

Connect the **SPEAKERS** terminals to your speakers with the wire with the proper gauge (keep it as short as possible). If the connections are faulty, no sound will be heard from the speakers. Make sure that the + and – polarity markings of the speaker wires are observed and set correctly. If these wires are reversed, the sound will be unnatural and lack bass.

- One or two speaker systems can be connected to this unit. If you use only one speaker system, connect it to either the **SPEAKERS A** or **B** terminals.
- Use speakers with the specified impedance shown on the rear of this unit.

Caution

Do not let the bare speaker wires touch each other or any metal part of this unit. This could damage this unit or the speakers, or both.

How to Connect:

SPEAKERS A terminals

Red: positive (+)
Black: negative (–)

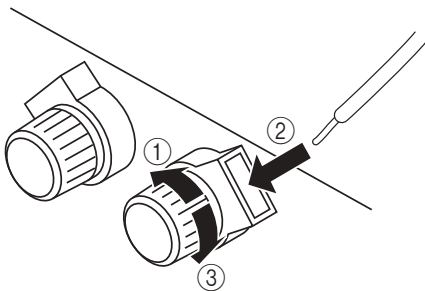

- ① Loosen the knob.
- ② Insert the bare wire. [Remove approx. 10 mm (3/8") insulation from the speaker wires.]
- ③ Tighten the knob and secure the wire.

SPEAKERS B terminals

Red: positive (+)
Black: negative (–)

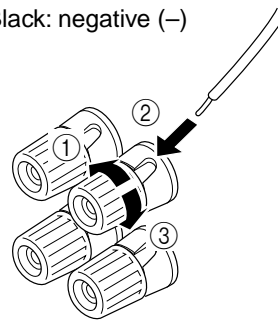

- ① Loosen the knob.
- ② Insert the bare wire. [Remove approx. 10 mm (3/8") insulation from the speaker wires.]
- ③ Tighten the knob and secure the wire.

<U.S.A., Canada, Australia, China and General models only>

Banana Plug connections are also possible.

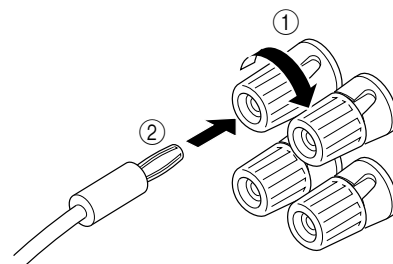

- ① Tighten the terminal knob.
- ② Simply insert the Banana Plug connector into the terminal.

■ Rear panel parts

GND terminal (For turntable use) *¹

Connecting the ground wire of the turntable to the **GND** terminal will normally minimize hum, but in some cases better results may be obtained with the ground wire disconnected.

PRE OUT/MAIN IN terminals *²

Removing the jumper pins from the **PRE OUT/MAIN IN** terminals enables this unit to operate separately as a control amplifier and a power amplifier. These terminals are used for connecting a signal-processing system such as a graphic equalizer or a surround-sound processor to this unit.

If such an external unit is connected to these terminals, the **VOLUME** control of this unit can be used for adjusting the overall sound level.

To connect an external unit, first remove the jumper pins from the **PRE OUT/MAIN IN** terminals, and then connect the input terminals of that unit to the **PRE OUT** terminals and its output terminals to the **MAIN IN** terminals. For details, refer to the owner's manual included with the unit to be connected.

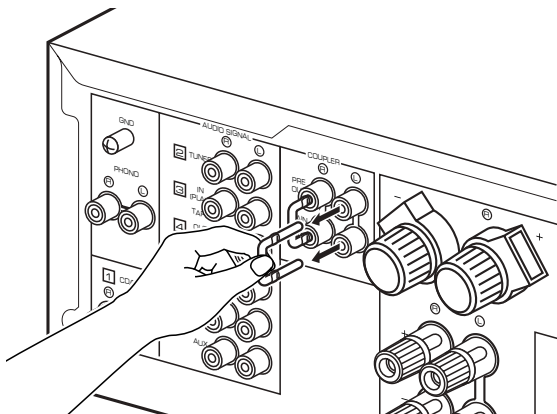

Notes

- When you do not use the **PRE OUT/MAIN IN** terminals, never remove the jumper pins from these terminals. If removed, no sound will be outputted from this unit.
- When you use this unit with an external unit connected to the **PRE OUT** and **MAIN IN** terminals, make sure that the **CD/DVD DIRECT AMP** switch and the **PURE DIRECT** switch on the front panel are turned off.
- When you use this unit as a power amplifier, connect the output terminals of an external control amplifier etc. to this unit's **MAIN IN** terminals. In this case, this unit's controls will not function except the **PHONES** jack and the **SPEAKERS** switches. Use the controls on the external control amplifier to make volume adjustment etc.

IMPEDANCE SELECTOR switch *³

WARNING

Do not change the IMPEDANCE SELECTOR switch setting while the power to this unit is on, otherwise this unit may be damaged.

If this unit fails to turn on when the **POWER** switch is pressed:

The **IMPEDANCE SELECTOR** switch may not be set to either end. If so, set the switch to either end when this unit's power supply is completely cut off.

Select the position whose requirements your speaker system meets.

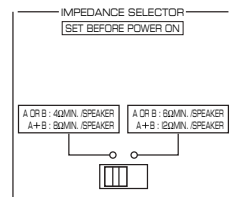

 (Left position)

If you use one pair of speakers, the impedance of each speaker must be 4Ω or higher.

If you use two pairs of speakers, the impedance of each speaker must be 8Ω or higher.

 (Right position)

If you use one pair of speakers, the impedance of each speaker must be 6Ω or higher.

If you use two pairs of speakers, the impedance of each speaker must be 12Ω or higher.

AC OUTLET(S) (SWITCHED) *⁴

(U.S.A., Canada, Europe, China and General models)

..... 3 SWITCHED OUTLETS

(U.K. and Australia models) 1 SWITCHED OUTLET

Use these to connect the power cords of your components to this unit.

The power to the **SWITCHED** outlets is controlled by this unit's **POWER** or **STANDBY/ON** switch. These outlets will supply power to any connected unit whenever this unit is turned on.

The maximum power (total power consumption of components) that can be connected to the **SWITCHED AC OUTLET(S)** is 100W.

OPERATION

■ Playing a source

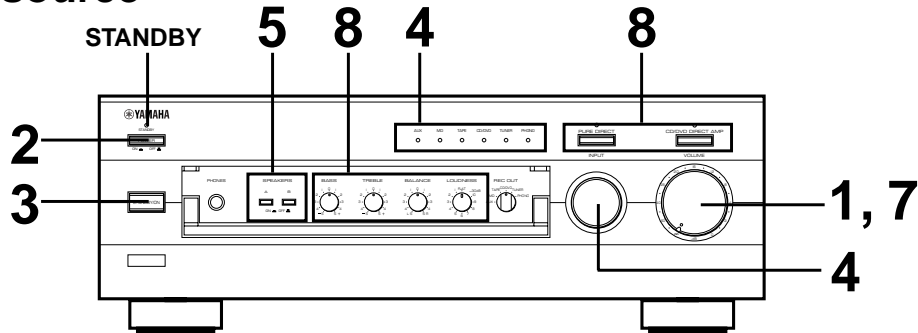

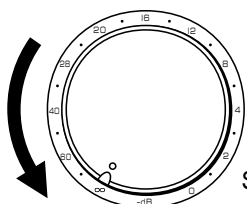
1  Set to the "∞" position.

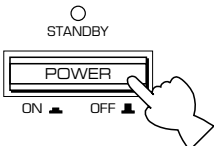
2 Press **POWER** inward (ON).

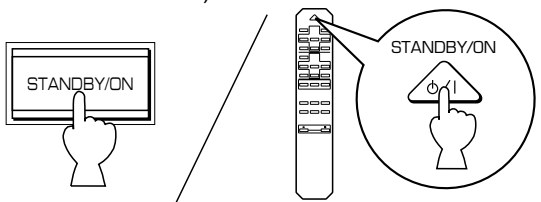
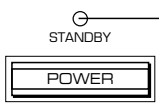
3 If the **STANDBY** indicator is illuminated, press **STANDBY/ON** to turn on the power. (The **STANDBY** indicator turns off.)

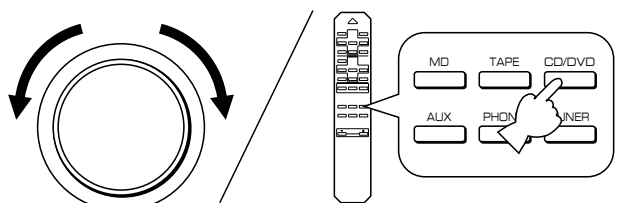
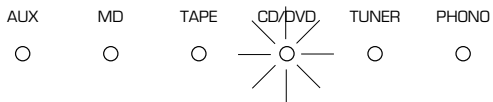
 Turns off.

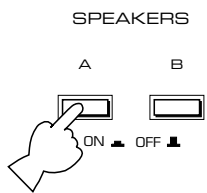
4 Select the desired input source.

 The indicator of the selected source lights up.

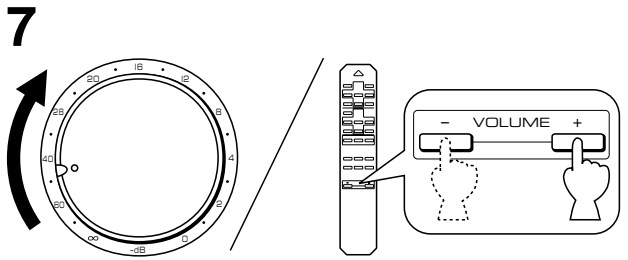
5 Select speakers A or B.

 * Both speakers A and B can be selected.
 * Be sure that the **IMPEDANCE SELECTOR** switch is correctly set as explained on page 9.
 * If you listen with headphones, press both switches to release them outward (OFF).

6 Play the source.

7 
 Adjust the output level.

8 Adjust the tonal quality by using the **BASS**, **TREBLE**, **BALANCE**, **LOUDNESS** controls, the **CD/DVD DIRECT AMP** switch or the **PURE DIRECT** switch. (Refer to page 12).

When you finish using this unit
 Press **STANDBY/ON** again to set this unit in the standby mode. (The **STANDBY** indicator lights up.)

To completely cut off this unit's power supply from the AC line
 Press **POWER** to release it outward (OFF).

■ Recording a source to tape (or MD)

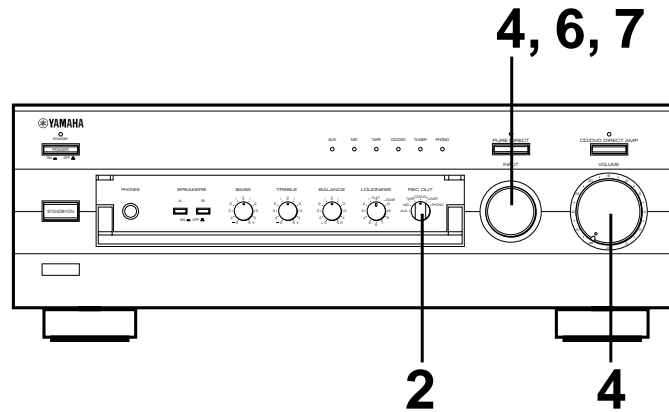

1 Follow the steps 1–3 of “**Playing a source**” on page 10.

2 Select the source you want to record.

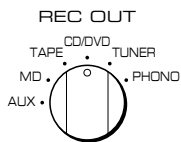

3 Play the source.

4 Select the source with the **INPUT** selector and adjust **VOLUME** to check the sound output.

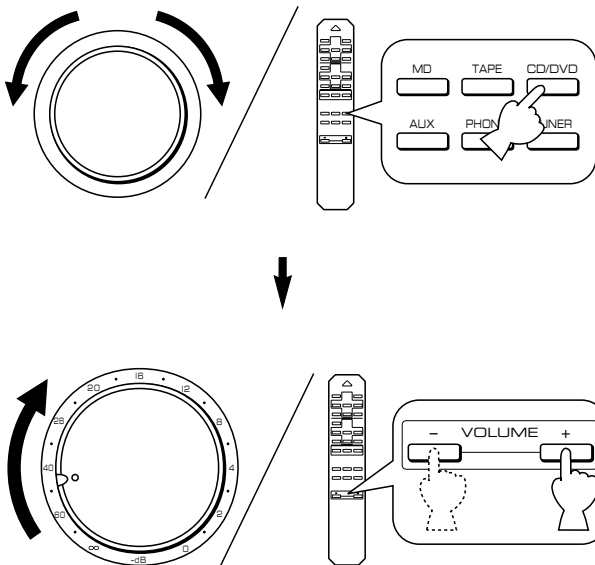

5 Begin recording on the tape deck (or MD recorder).

6 The sound of the recording can be monitored by selecting the tape deck (or MD recorder) with the **INPUT** selector.

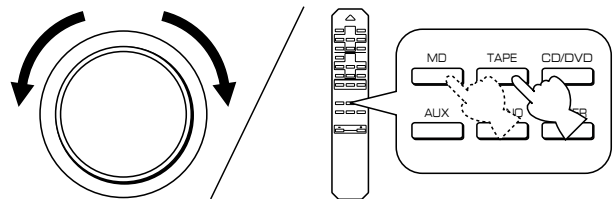

7 Listening to another source by selecting it with the **INPUT** selector will not affect the recording.

Notes

- The **VOLUME, BASS, TREBLE, BALANCE, LOUDNESS** controls, the **CD/DVD DIRECT AMP** switch and the **PURE DIRECT** switch have no effect on the material being recorded.
- Please check the copyright laws in your country to record from records, compact discs, radio, etc. Recording of copyright material may infringe on copyright laws.

■ Sound control

Adjusting the **BALANCE** control

Adjust the balance of the output volume to the left and right speakers to compensate for sound imbalance caused by speaker location or listening room conditions.



Using the **CD/DVD DIRECT AMP** switch

You can enjoy the purest possible sound from your CD or DVD player by pressing this switch. The indicator above it lights up. With this function on, input signals from the CD or DVD player are sent directly to the built-in special amplifier for CD/DVD bypassing the **INPUT** selector, the **BASS**, **TREBLE**, **BALANCE**, **LOUDNESS** controls and the **PRE OUT/MAIN IN** terminals, and then sent to the power amplifier. This signal routing reproduces the purest sound eliminating any alterations to the CD or DVD signals.

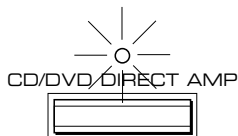

Using the **PURE DIRECT** switch

You can enjoy the purest possible sound from your audio sources by pressing this switch. The indicator above this switch lights up. With this function on, the audio signals bypass the **BASS**, **TREBLE**, **BALANCE**, **LOUDNESS** controls and the **PRE OUT/MAIN IN** terminals, thus eliminating any alterations to the audio signals.

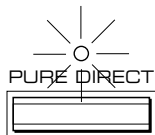

Notes

- If both the **CD/DVD DIRECT AMP** and **PURE DIRECT** switches are on, only the **CD/DVD DIRECT AMP** switch will function.
- If this unit is turned off, sound may be distorted when listening to a source with headphones that are connected to an externally connected unit such as the CD player, tape deck, etc.
- If any of the external units connected to this unit is turned off, sound may be distorted when playing a source on another unit that is also connected to this unit.

Adjusting the **BASS** and **TREBLE** controls

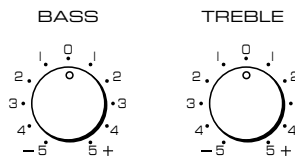

BASS: Turn this knob clockwise to increase (or counter-clockwise to decrease) the low frequency response.

TREBLE: Turn this knob clockwise to increase (or counter-clockwise to decrease) the high frequency response.

Adjusting the continuously variable **LOUDNESS** control

This control compensates for the human ears' loss of sensitivity to high and low-frequency ranges at low volume. This control is adjustable to retain full tonal range at any volume level.

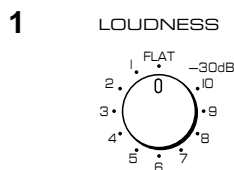

Set to the "FLAT" position.

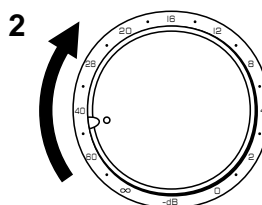

Set to the loudest listening level that you would listen to.

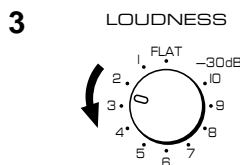

Turn until the desired volume is obtained.

WARNING

If the **CD/DVD DIRECT AMP** switch or **PURE DIRECT** switch is pressed to turn it on with the **LOUDNESS** control set at a certain level, the sound will suddenly increase and may damage your ears or the speakers. (The **LOUDNESS** control function may be bypassed.) For this reason, be sure to press the **CD/DVD DIRECT AMP** switch or **PURE DIRECT** switch after lowering the volume or after checking that the **LOUDNESS** control is properly set.

TROUBLESHOOTING

Refer to the chart below when this unit does not function properly. If the problem you are experiencing is not listed below or if the instructions given below do not help, disconnect the power cord and contact your authorized YAMAHA dealer or service center.

Problem	Cause	What to Do
The unit cannot be turned on or turns off suddenly soon after the power is turned on.	Power cord is not plugged in nor completely inserted.	Firmly plug in the power cord.
	The IMPEDANCE SELECTOR switch on the rear panel is not set to either end.	Set the switch to either end when this unit is off.
This unit does not work normally.	There is an influence of strong external noise (lightning, excessive static electricity, etc.) or a misoperation on this unit while using this unit.	Turn off this unit by pressing the POWER switch. After about 30 seconds have passed, turn on this unit and operate this unit again.
No sound.	Incorrect output cord connections.	Connect the cords properly. If the problem persists, the cords may be defective.
	Appropriate input source is not selected.	Select an appropriate input source with the INPUT selector.
	The SPEAKERS switches are not set properly.	Set the corresponding SPEAKERS switch to the ON position.
	Speaker connections are not secure.	Secure the connections.
The sound suddenly goes off.	The protection circuit has been activated because of short circuit etc.	Turn off this unit by pressing the POWER switch, and then turn this unit on to reset the protection circuit.
Only one of the speakers produces the sound.	Incorrect setting of the BALANCE control.	Adjust it to the appropriate position.
	Incorrect cord connections.	Connect the cords properly. If the problem persists, the cords may be defective.
There is a lack of bass and no ambience.	The + and – wires are connected in reverse at the amplifier or speakers.	Connect the speaker wires in the correct phase (+ and –).
Sound “hums”.	Incorrect cord connections.	Firmly connect the audio plugs. If the problem persists, the cords may be defective.
	No connection from the turntable to the GND terminal.	Make the GND connection between the turntable and this unit.
The volume level is low while playing a record.	The record is being played on a turntable with an MC cartridge.	The turntable should be connected to this unit through the MC head amplifier.
The volume level cannot be increased, or sound is distorted.	The component connected to the TAPE OUT or MD OUT terminals of this unit is turned off.	Turn on the power to the component.
The sound is degraded when listening with the headphones connected to the compact disc player or tape deck that are connected with this unit.	This unit is turned off or in the standby mode.	Turn on the power to this unit.
Sound level is low.	The LOUDNESS control is functioning.	Set the LOUDNESS control to the FLAT position.
The input source cannot be changed, though the INPUT selector is turned.	The CD/DVD DIRECT AMP switch is ON.	Switch off the CD/DVD DIRECT AMP switch.
Using the BASS, TREBLE, BALANCE and LOUDNESS controls does not affect the tone.	The CD/DVD DIRECT AMP switch or PURE DIRECT switch is ON.	The CD/DVD DIRECT AMP switch or PURE DIRECT switch must be switched OFF to use those controls.
The remote control does not work.	The batteries of this remote control are weak.	Replace the batteries with new ones.
The remote control does not function properly.	Wrong distance or angle.	The remote control will function from a maximum range of 6 meters and no more than 30 degrees off-axis from the front panel.
	Direct sunlight or lighting (of an inverter type fluorescent lamp etc.) is striking the remote control sensor of the main unit.	Reposition of the main unit.

SPECIFICATIONS

Power Section

Minimum RMS Output Power 8 Ω , 20 Hz to 20 kHz, 0.015% THD	100W+100W
Maximum Output Power (EIAJ) (1 kHz, 10% THD) 8/6 Ω	145/170W
Dynamic Power (IHF) 8/6/4/2 Ω	140/170/220/290W
DIN Standard Output Power (4 Ω , 1 kHz, 0.7% THD)	155W
IEC Output Power (8 Ω , 1 kHz, 0.015% THD)	110W
Power Band Width 8 Ω , 50W, 0.03% THD	10 Hz to 50 kHz
Damping Factor 8 Ω , 20 Hz to 20 kHz	320
Frequency Response	20 Hz to 20 kHz \pm 0.5 dB 20 Hz to 100 kHz +0.5, -3 dB
Total Harmonic Distortion (20 Hz to 20 kHz) CD/DVD to SP OUT (8 Ω , 50W)	0.008%
Signal-to-Noise Ratio (IHF-A Network) CD/DVD (Input Shorted, CD/DVD DIRECT AMP: ON) PHONO (MM) (Input Shorted)	110 dB 92 dB
Residual Noise (IHF-A Network) CD/DVD DIRECT AMP: ON	35 μ V

Control Section

Input Sensitivity/Impedance CD/DVD, etc. PHONO (MM)	150 mV/47 k Ω 2.5 mV/47 k Ω
Output Level PRE OUT	1V/1.2 k Ω
REC OUT	150 mV/0.6 k Ω
Headphone Output	0.33V/680 Ω
Channel Separation (1 kHz/10 kHz) CD/DVD (Input 5.1 k Ω Terminated)	65 dB/50 dB
Tone Control Characteristics BASS	\pm 10 dB (20 Hz)
TREBLE	\pm 10 dB (20 kHz)
Continuous LOUDNESS Control Attenuation	-30 dB (1 kHz)

General

Power Supply [U.S.A. and Canada models]	AC 120V, 60 Hz
[Europe and U.K. models]	AC 230V, 50 Hz
[Australia model]	AC 240V, 50 Hz
[China and General models]	AC 110/120/220/240V, 60/50 Hz
Power Consumption	Approx. 220W
AC Outlets 3 SWITCHED OUTLETS [U.S.A., Canada, Europe, China and General models]	100W max. total
1 SWITCHED OUTLET [U.K. and Australia models]	100W max. total
Dimensions (W x H x D)	435 x 151 x 396 mm (17-1/8" x 5-15/16" x 15-9/16")
Weight	10.6 kg (23 lbs. 5 oz.)
Accessories	Remote control Batteries

Specifications subject to change without notice.