

SHURE®

LEGENDARY
PERFORMANCE™

STEREO WIRELESS
PERSONAL MONITORING SYSTEM

PSM® 300 USER GUIDE

Le Guide de l'Utilisateur
Bedienungsanleitung
Guia del Usuario
Guida dell'Utente
Manual do Usuário
Gebruikershandleiding
Руководство пользователя



© 2016 Shure Incorporated
27A31318 (Rev. 1)
Printed in China



IMPORTANT SAFETY INSTRUCTIONS

1. READ these instructions.
2. KEEP these instructions.
3. HEED all warnings.
4. FOLLOW all instructions.
5. DO NOT use this apparatus near water.
6. CLEAN ONLY with dry cloth.
7. DO NOT block any ventilation openings. Allow sufficient distances for adequate ventilation and install in accordance with the manufacturer's instructions.
8. DO NOT install near any heat sources such as open flames, radiators, heat registers, stoves, or other apparatus (including amplifiers) that produce heat. Do not place any open flame sources on the product.
9. DO NOT defeat the safety purpose of the polarized or grounding type plug. A polarized plug has two blades with one wider than the other. A grounding type plug has two blades and a third grounding prong. The wider blade or the third prong are provided for your safety. If the provided plug does not fit into your outlet, consult an electrician for replacement of the obsolete outlet.
10. PROTECT the power cord from being walked on or pinched, particularly at plugs, convenience receptacles, and the point where they exit from the apparatus.
11. ONLY USE attachments/accessories specified by the manufacturer.
12. USE only with a cart, stand, tripod, bracket, or table specified by the manufacturer, or sold with the apparatus. When a cart is used, use caution when moving the cart/apparatus combination to avoid injury from tip-over.
13. UNPLUG this apparatus during lightning storms or when unused for long periods of time.
14. REFER all servicing to qualified service personnel. Servicing is required when the apparatus has been damaged in any way, such as power supply cord or plug is damaged, liquid has been spilled or objects have fallen into the apparatus, the apparatus has been exposed to rain or moisture, does not operate normally, or has been dropped.
15. DO NOT expose the apparatus to dripping and splashing. DO NOT put objects filled with liquids, such as vases, on the apparatus.
16. The MAINS plug or an appliance coupler shall remain readily operable.
17. The airborne noise of the Apparatus does not exceed 70dB (A).
18. Apparatus with CLASS I construction shall be connected to a MAINS socket outlet with a protective earthing connection.
19. To reduce the risk of fire or electric shock, do not expose this apparatus to rain or moisture.
20. Do not attempt to modify this product. Doing so could result in personal injury and/or product failure.
21. Operate this product within its specified operating temperature range.



WARNING: This product contains a chemical known to the State of California to cause cancer and birth defects or other reproductive harm.

低功率電波輻射性電機管理辦法

第十二條

經型式認證合格之低功率射頻電機，非經許可，公司、商號或使用者均不得擅自變更頻率、加大功率或變更原設計之特性及功能。第十四條

低功率射頻電機之使用不得影響飛航安全及干擾合法通信；經發現有干擾現象時，應立即停用，並改善至無干擾時方得繼續使用。前項合法通信，指依電信法規定作業之無線電通信。低功率射頻電機須忍受合法通信或工業、科學及醫療用電波輻射性電機設備之干擾。

SAFETY PRECAUTIONS

The possible results of incorrect use are marked by one of the two symbols—"WARNING" and "CAUTION"—depending on the imminence of the danger and the severity of the damage.



WARNING: Ignoring these warnings may cause severe injury or death as a result of incorrect operation.



CAUTION: Ignoring these cautions may cause moderate injury or property damage as a result of incorrect operation.

CAUTION

- Never disassemble or modify the device, as failures may result.
- Do not subject to extreme force and do not pull on the cable or failures may result.
- Keep the product dry and avoid exposure to extreme temperatures and humidity.

WARNING

- If water or other foreign objects enter the inside of the device, fire or electric shock may result.
- Do not attempt to modify this product. Doing so could result in personal injury and/or product failure.

This device is able to produce sound volume higher than 85 dB SPL. Please check your maximum allowed continuous noise exposure level based on your national employment protection requirements.

WARNING

LISTENING TO AUDIO AT EXCESSIVE VOLUMES CAN CAUSE PERMANENT HEARING DAMAGE. USE AS LOW A VOLUME AS POSSIBLE. Over exposure to excessive sound levels can damage your ears resulting in permanent noise-induced hearing loss (NIHL). Please use the following guidelines established by the Occupational Safety Health Administration (OSHA) on maximum time exposure to sound pressure levels before hearing damage occurs.

90 dB SPL at 8 hours	95 dB SPL at 4 hours	100 dB SPL at 2 hours	105 dB SPL at 1 hour
110 dB SPL at ½ hour	115 dB SPL at 15 minutes	120 dB SPL Avoid or damage may occur	

PSM[®]300

The PSM300 Personal Monitor System delivers wireless stereo monitoring for improved clarity and reduced feedback over traditional stage wedges. Performers can create their own custom mixes by adjusting the stereo blend and overall volume level at the bodypack, resulting in lower volume on stage and enhanced audio detail. Easy to set up and operate, PSM300 features one-touch frequency syncing and solid wireless RF stability between transmitters and receivers. With rugged, dependable hardware and hard-working technology, Shure PSM300 Personal Monitor Systems deliver a greatly improved monitoring experience on stage.

Features

- Send two channels of audio wirelessly to performers onstage
- Solid RF connection over a 300 foot (90 meter) range
- Create a personal mix on each bodypack with adjustable stereo balance or MixMode[®] two-channel mono blend.
- Up to 90 dB signal-to-noise ratio provides clear, detailed audio at any volume
- Systems available with Shure Sound Isolating[™] earphones
- One-touch scan and IR sync quickly and easily assigns a clean wireless channel
- No complicated menus, just simple volume and mix controls that focus on the performance
- All-metal half-rack transmitter
- Slim, lightweight bodypack attaches easily to a belt or guitar strap

Included Components

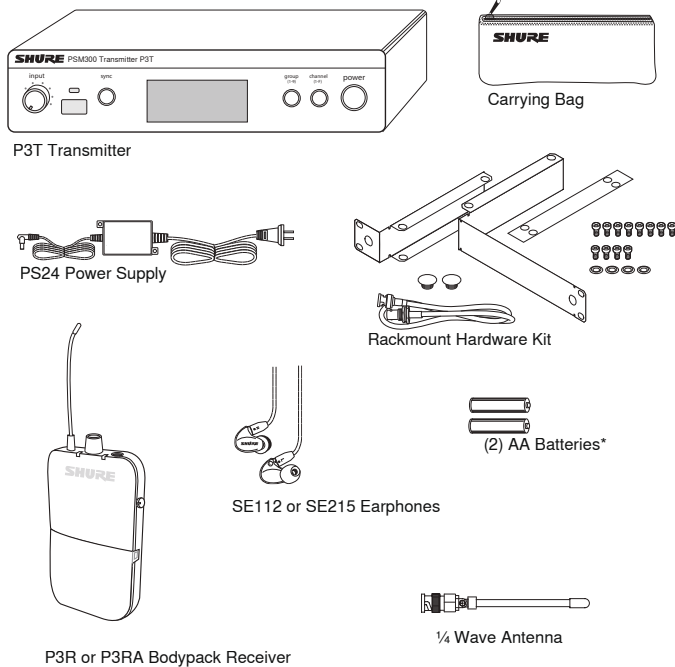

*Not included in Argentina

System Overview

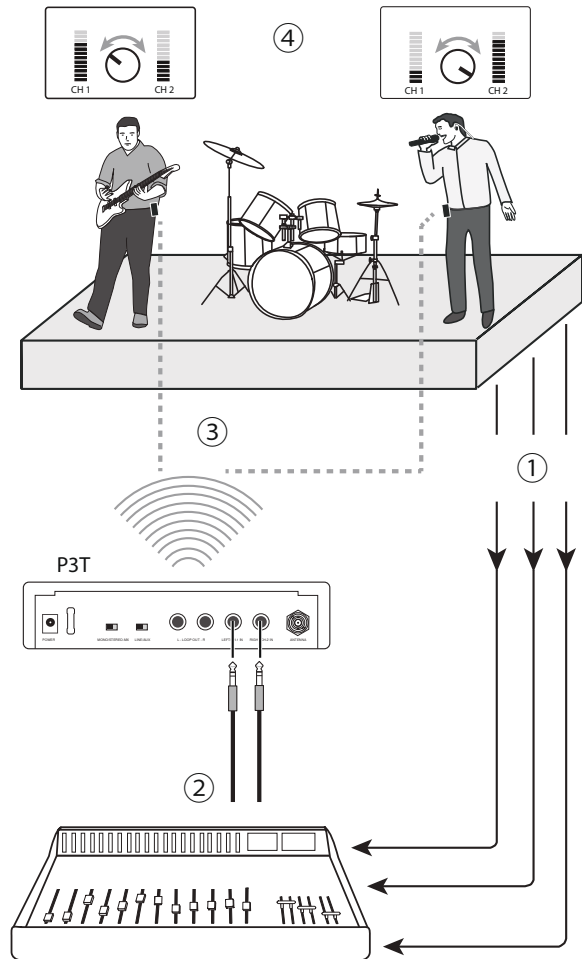

This example shows a typical setup for musical performance. See the System Applications section for additional examples.

- 1 Route audio signals**
 Send Instrument and microphone signals from the stage to a mixer or PA system.
- 2 Create monitor mixes**
 From the mixer, create two mixes: one of just the instruments, and a second with just the vocals. Route each of these to separate mixer outputs and connect them to the P3T inputs.
- 3 Send wireless audio to the performers**
 Sync the bodypacks to the P3T transmitter to send the mixes to the performers for in-ear monitoring.
- 4 Adjust personal mixes**
 Each performer uses the MixMode knob on the bodypack to control their own mix between the instruments and vocals .

P3T Transmitter Front and Rear Panels

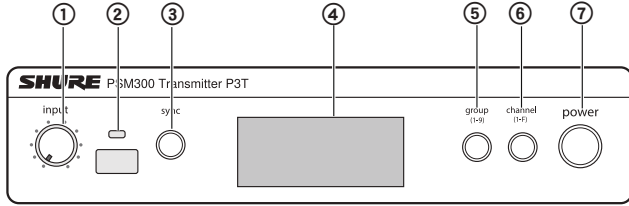

P3T Front Panel

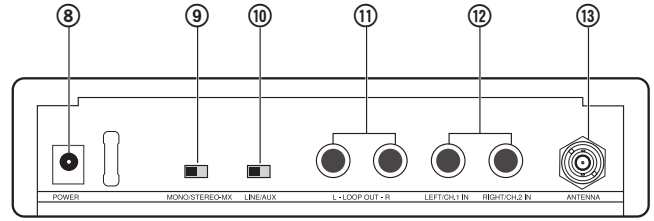

P3T Rear Panel

- ① **Input Level Control**
Adjusts the level of the incoming audio signal
- ② **IR Sync Window**
Sends and receives group/channel data to sync receivers with the transmitter
- ③ **Sync Button**
Press to synchronize the transmitter and receiver to the same group and channel
Note: Sync data is sent through the IR sync window
- ④ **LCD Display**
Displays audio, RF, and system information
- ⑤ **Group Button**
Press to scroll through group settings
- ⑥ **Channel Button**
Press to scroll through channel settings
- ⑦ **Power**
Turns power on or off
- ⑧ **Power Input**
Connect the supplied Shure PS23 external power supply

⑨ Mono/Stereo-MX Switch

StereoMX	Sends a two-channel stereo mix to the receiver
Mono	Sends a summed audio mix to both receiver channels

⑩ Line/Aux Switch

Adjust the input sensitivity using the following as a connection reference:

Aux (-10 dBV):	Consumer audio devices, such as computers or portable media players
Line (+4 dBu):	Mixers or other professional audio devices

⑪ Loop Outputs (¼ Inch TRS, Balanced)

Connect outputs to additional PSM systems or other audio devices

⑫ Audio Inputs (¼ Inch TRS, Balanced)

Connect to mixer outputs or other audio sources for monitoring by the performers

⑬ BNC Antenna Connector

Connect the supplied ¼ wave antenna, directional antenna, or a Shure P3AC antenna combiner

Note: For JB band models, the antenna is permanently fixed to the transmitter. Removing the antenna on JB band models is prohibited by law in Japan, and attempting to do so may cause damage to the transmitter.

P3T Transmitter Display

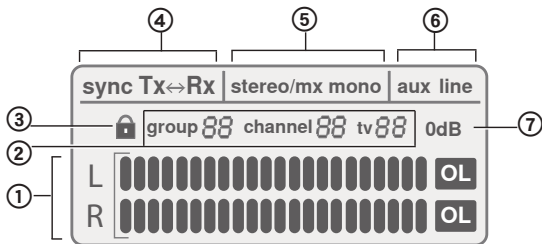

- ① **Audio Input Meter**
Indicates the audio signal level
- ② **Group / Channel / TV Setting**
Displays selected group and channel settings and the corresponding television channel
Note: the TV indicator only applies to U.S.A. channels, and remains blank in other regions

③ Lock Status

To lock or unlock the controls, press and hold the group and channel buttons until the lock icon appears/disappears.

④ Sync Status

Appears after a successful sync between the transmitter and receiver. The direction of the sync is shown as Tx>Rx (transmitter sends frequency to receiver) or Tx<Rx (receiver sends frequency to transmitter).

⑤ Stereo-MX / Mono Mix

Indicates whether the audio sent to the receiver is a single or two-channel mix (corresponds to the **Stereo-MX/Mono** switch on the rear panel).

⑥ Aux / Line Mode

Indicates the input sensitivity setting (corresponds to the **Aux/Line** switch on the rear panel)

⑦ 0 dB Indicator

Turns on when input signal reaches 0 dB. Refer to the section on adjusting gain and listening volume for information on how to use this icon.

P3R Wireless Receiver

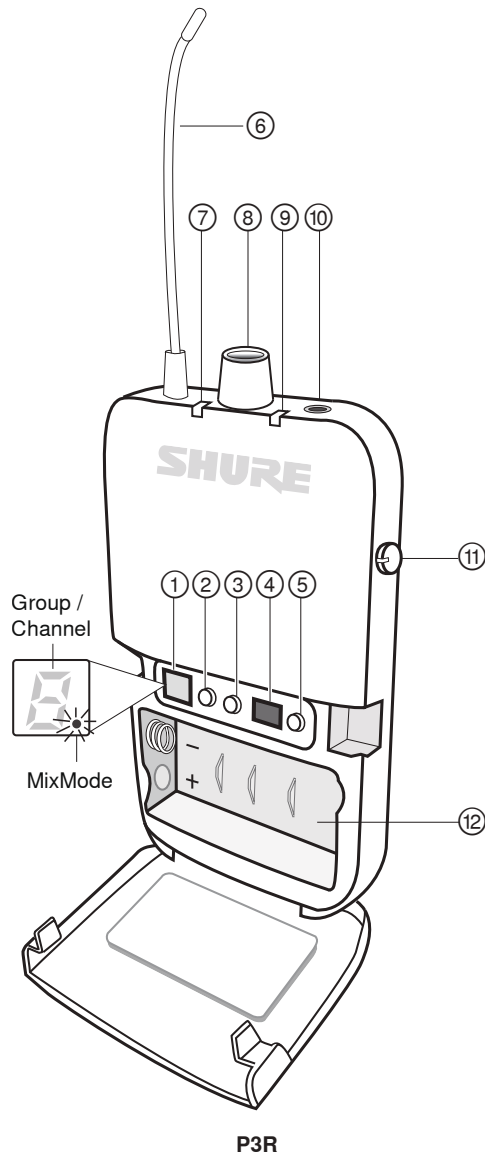

① Display

Shows group, channel, and MixMode settings

② Group Button

- Press to display group
- Press and hold to edit the group, then press to scroll when display flashes

③ Channel Button

- Press to display channel
- Press and hold to edit the channel, then press to scroll when display flashes

④ IR Sync Window

Sends and receives sync data between the receiver and transmitter

⑤ Scan Button

- Press and hold to perform a **group scan**
- Press to perform a **channel scan**

Note: A channel scan selects the best channel in the current group. A group scan finds the group with the most open channels and selects the first available channel in that group.

⑥ Antenna

⑦ Power LED Indicator

Indicates when receiver is on, remaining battery life, and when power-save mode is active. See battery life table for more information.

⑧ Power Switch / Volume Control Knob

Turns the receiver on/off and adjusts master headphone volume level

⑨ RF LED Indicator (blue)

Illuminates when tuned to an active transmitter group and channel

⑩ Headphone Output

Connects to earphones or headphones

⑪ MixMode Control Knob

- When operating in MixMode, this knob blends channels 1 and 2 into a single mix
- When operating in stereo mode, this knob adjusts the left/right balance

⑫ Battery Compartment

Holds 2 x AA batteries

P3RA Receiver

For more demanding applications, Shure offers the P3RA receiver, which features all-metal construction and advanced menu navigation in addition to the features included on the P3R receiver. For more information, please visit www.shure.com.

Battery Life

LED Behavior	Remaining Runtime (Hours)
Green	5-7
Amber	1-3
Red (solid)	0.5-1
Red (flashing)	0

Battery life was measured using Energizer™ alkaline batteries, under the following conditions:

- Transmitter sensitivity: Line (+4dBu)
- Audio output from receiver: 100 dB through Shure SE112 earphones

Power-save mode: When there are no earphones plugged in, the receiver enters power-save mode to preserve battery life. The LED slowly fades on/off in this mode and continues to display the color that represents the remaining battery life.

System Applications

Refer to the following PSM300 system scenarios prior to installation. Understanding the configuration options before setting up helps to identify signal routing requirements and plan for future expansion. Specific information on how to set up the PSM300 system and create mixes for monitoring can be found in the "System Setup and Configuration" and "Operation" sections of this user guide.

Single System for an Individual Performer

This configuration provides in-ear monitoring in a solo performance, or in a group performance in which only one person requires wireless monitoring. This system can be expanded for multiple performers by using additional P3R bodypack receivers tuned to the same transmitter.

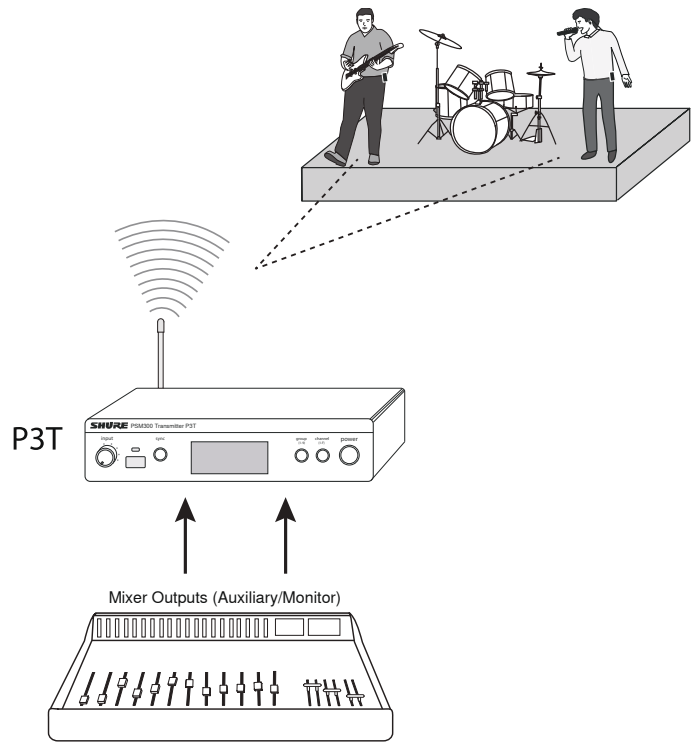
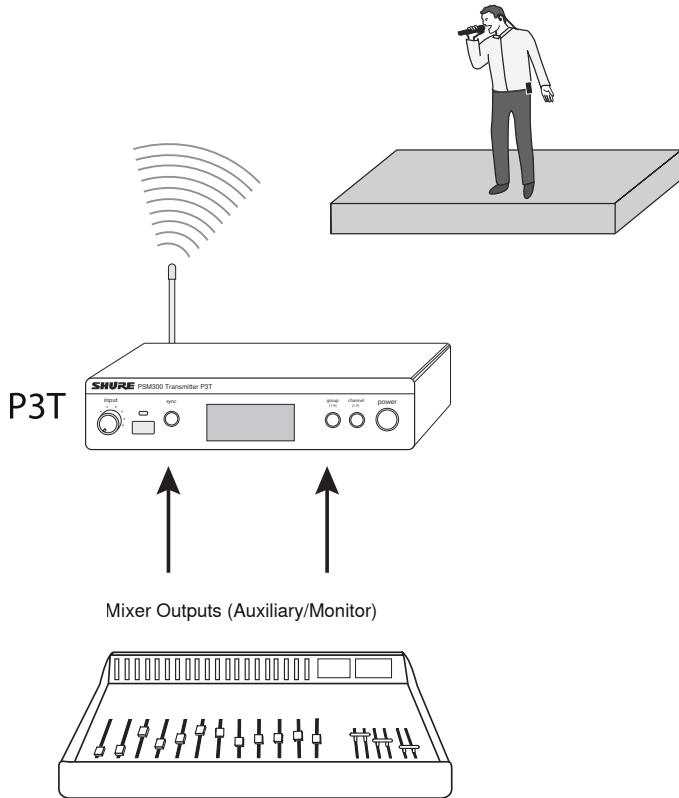

Multiple Transmitters with Separate Mixes

When several performers in a group have different monitoring requirements, multiple PSM300 systems may be used simultaneously to send different mixes through each transmitter. This setup requires a mixer with two monitor/auxiliary outputs for each transmitter.

Tip: To simplify setup in applications that involve multiple transmitters, Shure offers the P3AC antenna and power distribution system, which supplies up to four PSM transmitters with power and RF from a single source.

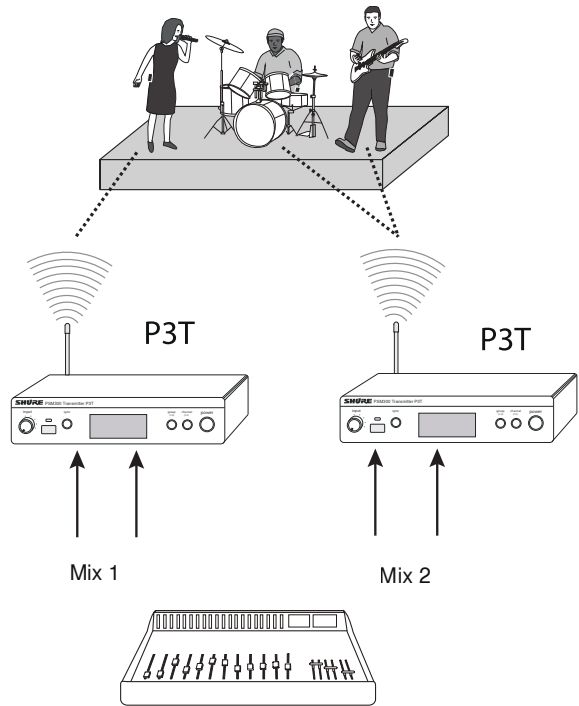

Single Transmitter with Multiple Receivers

Multiple performers can monitor audio from the same transmitter and still adjust the signal at their bodypack to personalize the mix. Simply tune each bodypack to the same frequency as the transmitter and use the MixMode knob to adjust the mix.

MixMode or Stereo Operation:

Each performer has the option of setting their bodypack to **MixMode** or **Stereo** when the transmitter is set to **Stereo-MX**. When the bodypack is powered on, it is set to stereo by default. To operate in MixMode, hold the **GROUP** button when turning the power on. For information on these modes, see "MixMode and Stereo Monitoring".

Signal Routing to External Devices (Combination Systems)

The **LOOP** outputs pass audio to an external device, such as other personal monitoring systems, recording devices, or stage monitors. The signal at the LOOP outputs is identical to the signal coming from the mixer, and is not affected by the transmitter volume or input sensitivity (line/aux) settings. This makes the LOOP outputs particularly useful when using a mixer that has one or two monitor/auxiliary sends.

Using the PSM300 simultaneously with Loudspeakers:

A combination monitoring system can be used, where some of the performers are using the PSM300 wireless system and others are listening through loudspeakers on stage.

Note: If using passive stage monitors, the P3T outputs must be connected to an amplifier. Active (amplified) speakers can be connected directly to the P3T outputs.

Using the PSM300 Combined with Other Wireless Monitoring Systems

In a scenario where two performers have their own wireless monitoring systems (one Shure PSM300 system and one third-party system, for example), the PSM300 can pass the signal from the mixer on to the second monitoring system.

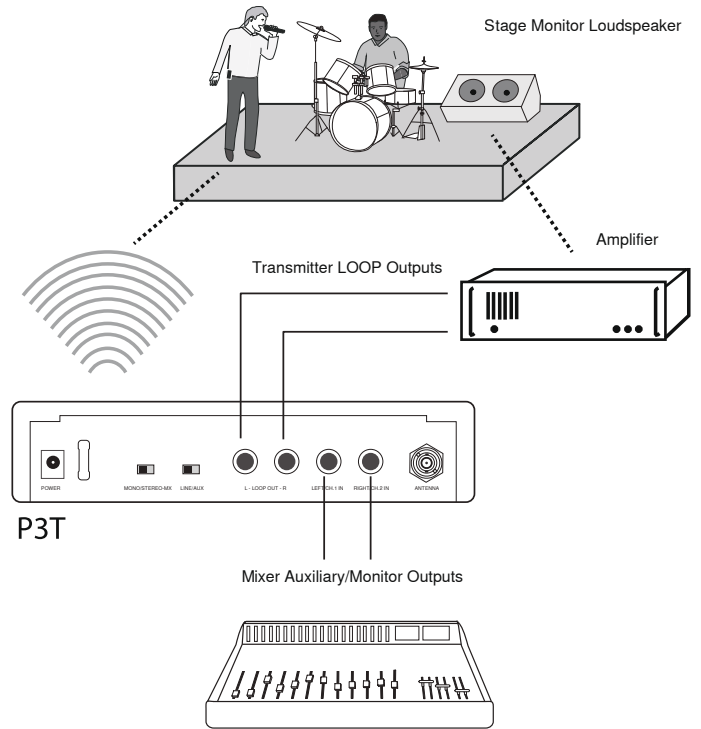

System Setup and Configuration

Rack Mounting

The P3T Transmitter can be mounted in a standard 19-inch rack. Up to two units can be mounted in a single rack space. If using multiple P3T transmitters, the Shure PA411 Antenna Combiner system can be used to consolidate and distribute all RF and power for up to four transmitters.

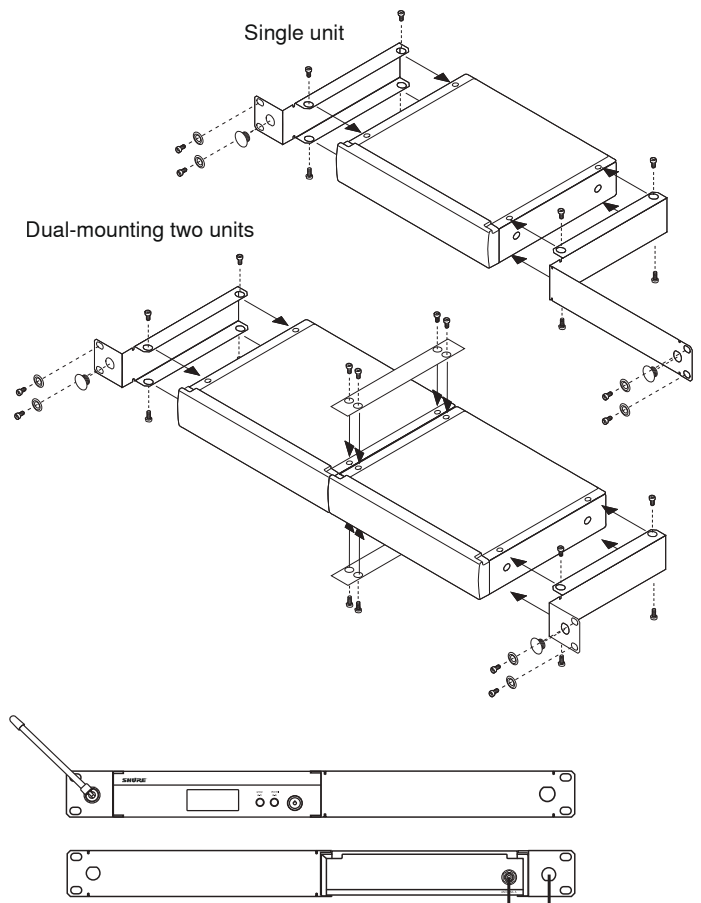

Note: Always use both straddle bars when mounting two units.

Power, Audio, and RF Connections

1. Use the power adapter to connect the P3T to an AC power source.
2. Install 2 AA batteries in the bodypack receiver.
3. Attach the antenna to the BNC antenna connector on the P3T rear panel.
4. Connect the mixer or audio source to the P3T audio inputs using ¼ inch balanced cables.

Important: When connecting to only one transmitter input, use the **LEFT/CH1** input. Set the transmitter to **MONO** to hear audio on both channels of the receiver.

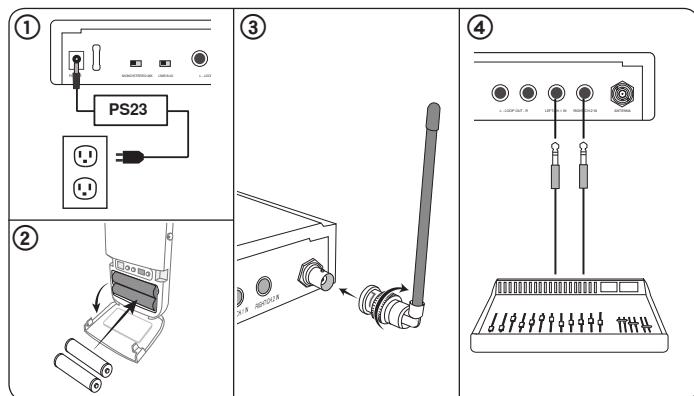

Creating a Wireless Connection Between Receivers and Transmitters (Sync)

To pass audio from the transmitter to the receiver, both must be tuned to the same frequency. The easiest way to configure the system is to use the automatic sync feature. This transfers group and channel settings with a press of a button. Based on your system configuration, use one of the following processes to sync the components:

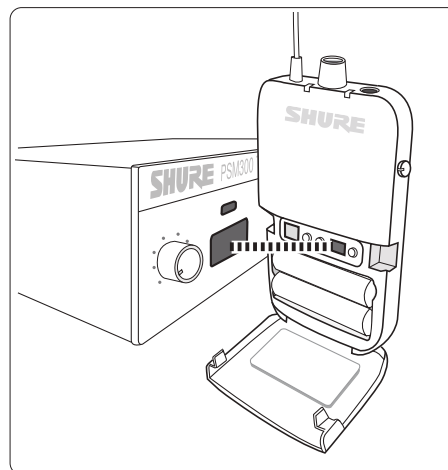

Align the IR windows to sync the receiver and transmitter

Scanning for the Best Open Channel

Follow these steps to scan the RF environment and find the best available frequency for operation:

1. Turn on the bodypack receiver and any potential sources of interference, including wireless systems, computers, audio equipment, cellular phones, LED panels, and other electronic devices that will be in use during a performance.
2. Make sure the P3T transmitter is **OFF**.
3. Position the receiver in the performance area and press **SCAN** to survey the available channels within the current group setting.

If using several PSM300 systems or operating in a location with a high volume of wireless devices, perform a group scan first, followed by a channel scan:

Group Scan: Press and hold the **SCAN** button on the receiver.

Channel Scan: Press the **SCAN** button on the receiver.

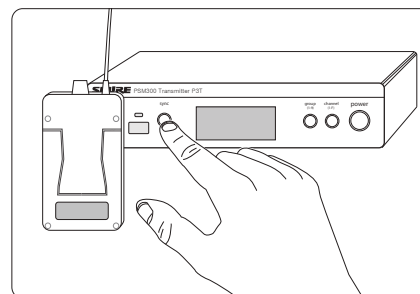
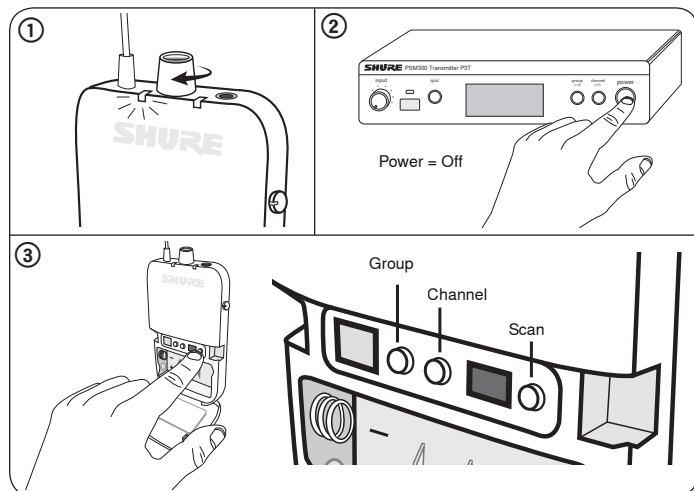

Pressing the **SYNC** button transfers group/channel data

Single Transmitter and Receiver

The following sync procedure should be used with a setup that consists of a single transmitter and receiver, unless a group/channel setting has been assigned prior to a performance.

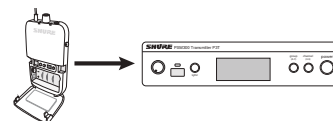

Sync from receiver to transmitter:

1. Perform a scan on the receiver (see "Scanning for the Best Open Channel" for best practices).
2. Align the IR windows on the receiver and transmitter. The windows should be 6-11 cm apart.
3. Press the **SYNC** button on the transmitter while the blue RF LED on the receiver is flashing.
4. The Transmitter displays **SYNC** when the sync is successful. The arrow between Rx (receiver) and Tx (transmitter) shows the direction of the sync.

Note: When the RF LED on the receiver is flashing after performing a scan, the receiver sends its frequency setting to the transmitter. After it stops flashing, pressing **SYNC** sends the frequency setting from the transmitter to the receiver.

Single Transmitter and Multiple Receivers

The following sync procedure should be used with a setup that consists of a single transmitter with multiple receivers, or if a specific group/channel setting has been assigned to the transmitter prior to a performance.

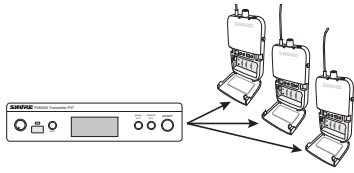

Sync from transmitter to receivers:

1. Sync the first receiver to the transmitter using the sync procedure for a single receiver. Performing a scan and using the resulting group and channel from the receiver is recommended.
2. Set additional receivers to the transmitter frequency (one at a time) using IR sync:

- Align the IR windows on the receiver and transmitter and press **SYNC**.
- The receiver LED should not be flashing when pressing **SYNC**.

Note: Receivers can also be manually tuned to the transmitter if an IR sync is not practical.

Multiple Transmitters and Multiple Receivers

1. Set up the first transmitter and all associated receivers according to the appropriate sync procedure. Keep the transmitter and all receivers from this first system powered on when setting up additional systems.
2. Set up each additional system using the appropriate sync process. Always leave each new system on before setting up an additional one.

Manual Selection

If frequencies have been planned ahead of time, the group and channel can be set manually without performing a scan. Refer to the frequency table at the end of this user guide to identify frequencies for each group/channel setting.

To select group/channel settings on the receiver and transmitter:

1. Press **GROUP** to scroll through group settings.
2. Press **CHANNEL** to scroll through channel settings within the selected group.

Adjusting Gain and Listening Volume

For the best audio quality, start by adjusting the levels from the mixer or audio source, and then adjust levels through the PSM300 system. This approach corresponds to the way that the audio signal flows through the system, and maximizes the signal-to-noise ratio.

Before you begin: verify all signal routing and gain settings at the mixer or source prior to adjusting any levels from the PSM300 system. If the sound is distorted or faint when it enters the P3T transmitter, there is likely an issue elsewhere in the signal chain that needs to be resolved.

① Adjust Transmitter Levels:

Input Sensitivity

Select the setting that matches the input source:

Line (+4 dBu)	Use with mixers or other professional audio devices that send line-level signals.
Aux (-10 dBV)	Use when connecting consumer audio devices such as portable audio players or computers.

Note: When using consumer audio devices, the output volume of the device should typically be adjusted as close to the maximum setting as possible without distorting or clipping at the output of the device. This maximizes the signal-to-noise ratio.

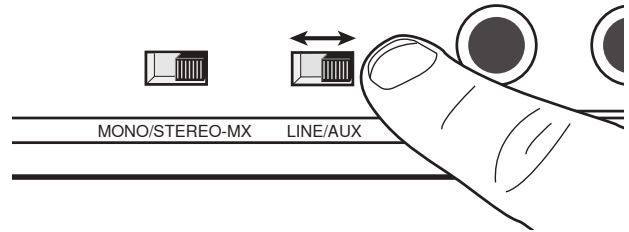

Input Level

Adjust the level so that average levels on the audio meter reach approximately 75% of the full range. The highest levels should occasionally hit the **0dB** indicator on the audio input meter, without reaching the **OL** (overload) indicator.

Tip: If a sound check before the performance is possible, everyone should play at the loudest anticipated volume so that attenuation is not required during the performance.

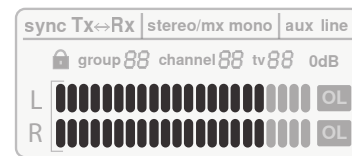
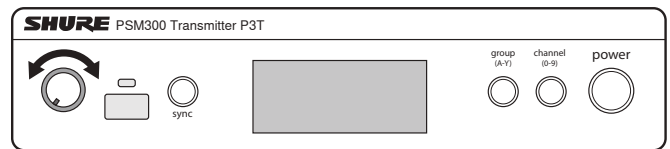

② Adjust Receiver Volume:

After levels are established at the mixer and transmitter, use the headphone volume control on the bodypack receiver to adjust overall listening volume. For information on adjusting the left/right balance or customizing the mix blend, see "MixMode and Stereo Monitoring".

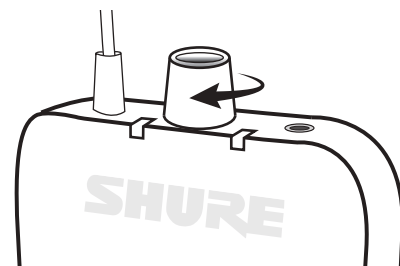

Creating Monitor Mixes

The mix that performers hear on stage is usually different than the mix heard by the audience. In live sound applications, the engineer creates a separate mix to send to the performer by routing the input signals to specified mixer outputs, usually called **Monitor** or **Auxiliary** outputs.

The following scenario demonstrates a generic signal path for monitoring mixes, and may not reflect the routing for all mixer types. Consult the user guide for your mixer for detailed signal routing options.

① Mixer Channel

Each mixer channel controls audio processing and routing for a single audio source. In this example, a vocal microphone is plugged into the mixer channel.

② Monitor/Auxiliary Sends

Adjust the signal levels to send to the monitor/auxiliary outputs, each of which corresponds to a separate monitoring mix. Each of these mixes are sent to separate channels on the P3T transmitter.

Note: The channel faders on most mixers do not affect the volume of the monitor/auxiliary sends.

③ Wireless Transmission

Each monitoring mix is transmitted on a separate channel to the P3R receiver. The MixMode knob on the bodypack adjusts the blend between the audio from channel 1 and channel 2.

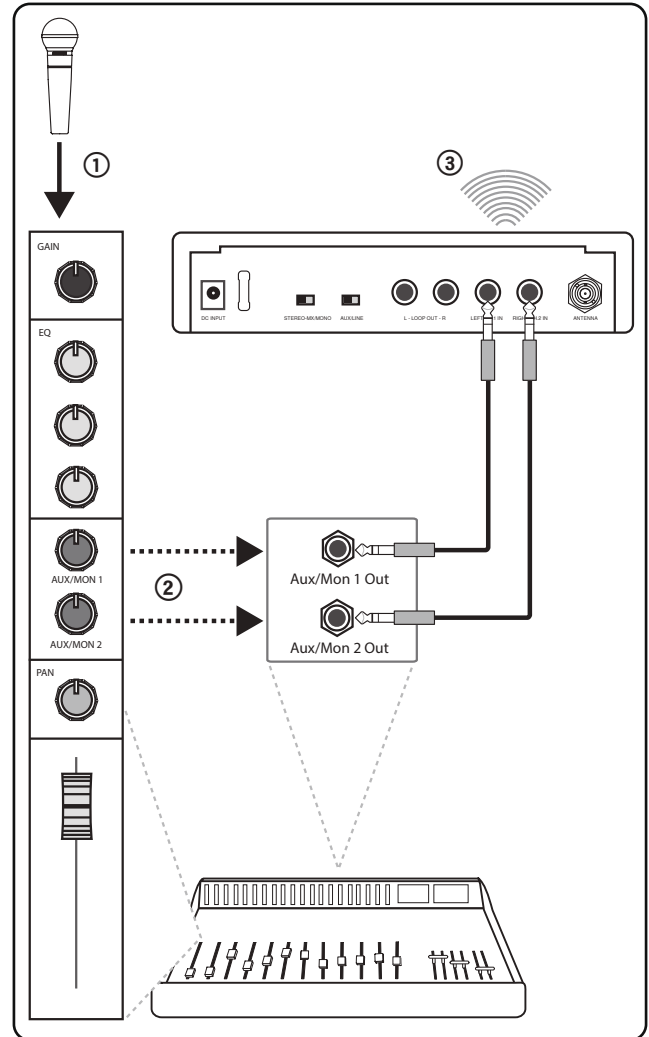

MixMode and Stereo Monitoring

The receiver can operate in stereo or MixMode when the transmitter is set to **STEREO-MX**. In applications that involve multiple bodypack receivers tuned to a single transmitter, some bodypacks can operate in stereo, while others operate in MixMode.

Selecting the Mode

Stereo: The receiver is set to stereo mode by default. To switch from MixMode to stereo, simply turn the receiver off and it will return to stereo mode when powered back on.

MixMode: Press and hold the **GROUP** button on the bodypack receiver while turning the power on. The MixMode indicator light on the receiver display turns on to confirm the setting. The receiver will return to stereo mode after it has been powered off.



Stereo

Audio from channel 1 is heard on the left earphone, while audio from channel 2 is heard on the right earphone. Listening in stereo mode increases separation between the sources on each channel, which can improve clarity when many sources are being monitored. The MixMode knob on the bodypack adjusts left/right balance when operating in stereo mode.

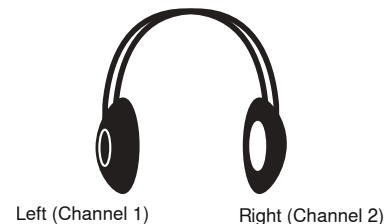

MixMode

MixMode allows performers to adjust the blend between two monitoring mixes (an instrumental mix and a vocal mix, for example). When using MixMode:

- Each mix is heard through both the left and right earphones
- The MixMode knob adjusts the volume blend between the two monitor mixes (channel 1 and channel 2)
- Each bodypack receiver can dial in a unique blend to meet the monitoring needs of each performer

Adjusting mix levels

In this scenario, an instrumental mix is on channel 1 and a vocal mix is on channel 2:

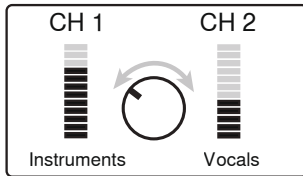

To hear more of channel one, turn the MixMode knob to the left.

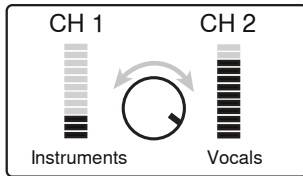

To hear more of channel two, turn the MixMode knob to the right.

When to Use the Mono Setting

In some cases, only a single input on the transmitter is used (if the mixer only features a single monitor/auxiliary output, for example). To ensure that audio is heard on both the left and right earphones:

- Use the LEFT/CH1 input on the transmitter
- Set the transmitter to **MONO**

Note: When the transmitter is set to mono operation, the MixMode knob will not affect the sound.

Troubleshooting

Problem	Solution
Distorted Audio	<ul style="list-style-type: none"> • Check the volume levels at the P3T transmitter and verify that the meter is not reaching the overload indicator • Check levels going in and out of the mixer. If audio is distorting anywhere in the signal chain, it will be distorted even if the PSM300 system is not overloading. • Make sure batteries in the receiver are fresh • Verify that the cables are 1/4 inch balanced. If an unbalanced instrument or speaker cable is used, it may introduce noise. Tip: To tell the difference, look at the connectors on the cable. The metal connector on a balanced cable has two plastic rings that divide it into three separate sections (tip, ring, sleeve). An unbalanced cable only has a single plastic ring that divides the metal portion into two sections (tip, sleeve). • Check that all cables are plugged all the way into the mixer and the P3T inputs. Sometimes, if a cable is not fully inserted, the signal will be faint and distorted. • Make sure you are using the line-level outputs from the mixer. If you have a powered mixer, do not use the main speaker outputs, as they are amplified signals and will overload the P3T inputs.
No sound from receiver	<ul style="list-style-type: none"> • Make sure the transmitter and receiver are linked to the same group and channel • Verify levels are registering at the transmitter and that the volume is turned up on the receiver • Check that the receiver is on and that the headphones are properly connected to the receiver
Turning the MixMode knob does not affect the sound	<ul style="list-style-type: none"> • The Stereo-MX/Mono switch on the rear panel of the P3T may be switched to mono. For the MixMode knob to work, the transmitter must be set to Stereo-MX. • Verify that the signals going from the mixer to the transmitter are not identical • Check that the bodypack is set to MixMode
Low audio output at the receiver	<ul style="list-style-type: none"> • Check headphone connection and volume level • If only sending a single channel into the P3T transmitter, check if the MixMode knob isn't turned towards a silent channel. If using one channel, set the P3T transmitter to mono mode.
Audio or RF drops out	<ul style="list-style-type: none"> • Perform a scan to ensure the receiver is on a clear (available) frequency • Make sure there is a line-of-sight path between the transmitter antenna and the bodypack receivers • Verify that other wireless devices that are being monitored, such as wireless microphones, are not experiencing RF dropouts • If using an antenna other than the one included with the system, make sure it is designed to operate in the correct frequency range
IR sync failure	Verify distance between receiver and transmitter is between 6-11 cm

Specifications

RF Carrier Range

488-937.5 MHz
varies by region

Compatible Frequencies

Per band
up to 15

Tuning Bandwidth

24 MHz Maximum
Note: varies by region

Operating Range

environment dependent
90 m (300 ft)

Audio Frequency Response

38 Hz–15 kHz

Signal-To-Noise Ratio

A-Weighted
90 dB (typical)

Total Harmonic Distortion

ref. ±34 kHz deviation @1 kHz
<0.5% (typical)

Companding

Patented Shure Audio Reference
Companding

Spurious Rejection

ref. 12dB SINAD
>80 dB (typical)

Latency

<0.7 ms

Frequency Stability

±2.5 ppm

MPX Pilot Tone

19 kHz (±1 Hz)

Modulation

FM*, MPX Stereo
*ref. ±34 kHz deviation @1 kHz

Operating Temperature

-18°C to +63°C

P3T

RF Output Power

10, 20, 30 mW
Note: varies by region

RF Output Impedance

50 Ω (typical)

Net Weight

783 g(27.6 oz.)

Dimensions

43 x 198 x 172 mm (1.7 x 7.8 x 6.8 in.),
H x W x D

Power Requirement

12-15V DC, 260 mA Maximum

Audio Input

Connector Type

6.35 mm (1/4") TRS

Polarity

Tip positive with respect to ring

Configuration

Electrically balanced

Impedance

40 kΩ (actual)

Nominal Input Level

switchable: +4 dBu, -10 dBV

Maximum Input Level

+4 dBu	+22 dBu
-10 dBV	+12.2 dBu

Pin Assignments

Tip=hot, Ring=cold, Sleeve=ground

Phantom Power Protection

Up to 60 V DC

Audio Output

Connector Type

6.35 mm (1/4") TRS

Configuration

Electrically balanced

Impedance

Connected directly to inputs

P3R

Active RF Sensitivity

at 20 dB SINAD

2.2 μV

Image Rejection

>90 dB

Adjacent Channel Rejection

>60 dB

Intermodulation Attenuation

>50 dB

Blocking

>60 dB

Audio Output Power

1kHz @ <1% distortion, peak power, @32Ω

40 mW + 40 mW

Minimum Load Impedance

4 Ω

Headphone Output

3.5 mm (1/8") stereo

Output Impedance

<2.5 Ω

Net Weight

98 g(3.5 oz.) (without batteries)

Dimensions

110 x 64 x 21 mm H x W x D

Battery Life

5–7 hours (continuous use) AA batteries

Frequency Range and Transmitter Output Power

Band	Range	Output Power
G20	488 to 512 MHz	30 mW
H8E	518 to 542 MHz	10 mW
H20	518 to 542 MHz	30 mW
J10	584 to 608 MHz	30 mW
J13	566 to 590 MHz	30 mW
JB	806 to 810 MHz	10 mW
K3E	606 to 630 MHz	30 mW
K12	614 to 638 MHz	30 mW
L18	630 to 654 MHz	10 mW
L19	630 to 654 MHz	30 mW
M16	686 to 710 MHz	30 mW
M18	686 to 710 MHz	10 mW
Q25	742 to 766 MHz	30 mW
R12	794 to 806 MHz	10 mW
S8	823 to 832 MHz	20 mW
T11	863 to 865 MHz	10 mW
X7	925 to 937.5	10 mW

Note: Frequency bands might not be available for sale or authorized for use in all countries or regions.

NOTE: This Radio equipment is intended for use in musical professional entertainment and similar applications. This Radio apparatus may be capable of operating on some frequencies not authorized in your region. Please contact your national authority to obtain information on authorized frequencies and RF power levels for wireless microphone products.

Optional Accessories and Replacement Parts

Bodypack receiver	P3R
Half-rack Transmitter	P3T
Universal bodypack receiver	P3RA
Antenna and power distribution system	PA411
Wired PSM bodypack	P9HW
Dynamic MicroDriver earphones	SE112
Dynamic MicroDriver earphones	SE215
High-definition MicroDriver earphones with tuned bass port High-definition MicroDriver earphones with tuned bass port	SE315
High-definition earphones with dual MicroDrivers	SE425
High-definition earphones with triple MicroDrivers High-definition earphones with triple MicroDrivers	SE535
High-definition earphones with quad MicroDrivers	SE846
Carrying/Storage Bag	95A2313
1/4 Wave Antenna (748–865 MHz) for SLX Wireless System 1/4 Wave Antenna (748–865 MHz) for SLX Wireless System	UA400
1/4 wave antenna (470-752 MHz)	UA400B
Single Rack Mount Kit	RPW503
Dual Rack Mount Kit	RPW504

Certifications

This product meets the Essential Requirements of all relevant European directives and is eligible for CE marking.

The CE Declaration of Conformity can be obtained from: www.shure.com/europe/compliance

Authorized European representative:
Shure Europe GmbH
Headquarters Europe, Middle East & Africa
Department: EMEA Approval
Jakob-Dieffenbacher-Str. 12
75031 Eppingen, Germany
Phone: 49-7262-92 49 0
Fax: 49-7262-92 49 11 4
Email: info@shure.de

P3R

Approved under the Declaration of Conformity (DoC) provision of FCC Part 15.

Complies with requirements set out in RSS-GEN.

Industry Canada ICES-003 Compliance Label: CAN ICES-3 (B)/NMB-3(B)

This device complies with Industry Canada licence-exempt RSS standard(s). Operation of this device is subject to the following two conditions: (1) this device may not cause interference, and (2) this device must accept any interference, including interference that may cause undesired operation of the device.

Le présent appareil est conforme aux CNR d'Industrie Canada applicables aux appareils radio exempts de licence. L'exploitation est autorisée aux deux conditions suivantes : (1) l'appareil ne doit pas produire de brouillage, et (2) l'utilisateur de l'appareil doit accepter tout brouillage radioélectrique subi, même si le brouillage est susceptible d'en compromettre le fonctionnement.

P3T

Certified under FCC Part 74.

Certified by IC in Canada under RSS-123 and RSS-102.

IC: 616A-P3TA, 616A-P3TB, 616A-P3TD.

FCC: DD4P3TA, DD4P3TB, DD4P3TD, DD4P3TT.

Certified by IC in Canada under RSS-102 and RSS-210.

IC: 616A-P3TT.

This device operates on a no-protection no-interference basis. Should the user seek to obtain protection from other radio services operating in the same TV bands, a radio licence is required. Please consult Industry Canada's document CPC-2-1-28, Optional Licensing for Low-Power Radio Apparatus in the TV Bands, for details.

The antenna(s) must be installed such that a minimum separation distance of 20 cm is maintained between the radiator (antenna) and all persons at all times.

Important Product Information

LICENSING INFORMATION

Licensing: A ministerial license to operate this equipment may be required in certain areas. Consult your national authority for possible requirements. Changes or modifications not expressly approved by Shure Incorporated could void your authority to operate the equipment. Licensing of Shure wireless microphone equipment is the user's responsibility, and licensability depends on the user's classification and application, and on the selected frequency. Shure strongly urges the user to contact the appropriate telecommunications authority concerning proper licensing, and before choosing and ordering frequencies.

Information to the user

This equipment has been tested and found to comply with the limits for a Class B digital device, pursuant to Part 15 of the FCC Rules. These limits are designed to provide reasonable protection against harmful interference in a residential installation. This equipment generates uses and can radiate radio frequency energy and, if not installed and used in accordance with the instructions, may cause harmful interference to radio communications. However, there is no guarantee that interference will not occur in a particular installation. If this equipment does cause harmful interference to radio or television reception, which can be determined by turning the equipment off and on, the user is encouraged to try to correct the interference by one or more of the following measures:

- Reorient or relocate the receiving antenna.
- Increase the separation between the equipment and the receiver.
- Connect the equipment to an outlet on a circuit different from that to which the receiver is connected.
- Consult the dealer or an experienced radio/TV technician for help.

Industry Canada ICES-003 Compliance Label: CAN ICES-3 (B)/NMB-3(B)

Note: EMC conformance testing is based on the use of supplied and recommended cable types. The use of other cable types may degrade EMC performance.

Changes or modifications not expressly approved by the manufacturer could void the user's authority to operate the equipment.

Please follow your regional recycling scheme for batteries, packaging, and electronic waste.

Australia Warning for Wireless

This device operates under an ACMA class licence and must comply with all the conditions of that licence including operating frequencies. Before 31 December 2014, this device will comply if it is operated in the 520-820 MHz frequency band. **WARNING:** After 31 December 2014, in order to comply, this device must not be operated in the 694-820 MHz band.

FREQUENCIES FOR EUROPEAN COUNTRIES

	Country Code Code de Pays Codice di paese Código de país Länder-Kürzel	Frequency Range Gamme de frequences Gamma di frequenza Gama de frecuencias Frequenzbereich
PSM300-H8E 518 - 542 MHz max. 10 mW	A, B, BG, CH, CY, CZ, D, DK, EST, F,	518 - 542 MHz*
	FIN, GB, GR, H, HR, I, IRL, IS, L, LT,	518 - 542 MHz*
	M, N, NL, P, PL RO, S, SK, SLO, TR	518 - 542 MHz*
	All other countries	*
PSM300-H20 518-542 MHz max. 30 mW	A, B, BG, CH, CY, CZ, D, DK, EST, F,	518-542 MHz*
	FIN, GB, GR, H, HR, I, IRL, IS, L, LT,	518-542 MHz*
	M, N, NL, P, PL RO, S, SK, SLO, TR	518-542 MHz*
	All other countries	*
PSM300-K3E 606 - 630 MHz max. 30 mW	A, B, BG, CH, CY, CZ, D, DK, EST, F,	606-630 MHz *
	FIN, GB, GR, H, HR, I, IRL, IS, L, LT,	606-630 MHz *
	M, N, NL, P, PL RO, S, SK, SLO, TR	606-630 MHz *
	All other countries	*
PSM300-K12 614 - 638 MHz max. 30 mW	A, B, BG, CH, CY, CZ, D, DK, EST, F,	614-638 MHz*
	FIN, GB, GR, H, HR, I, IRL, IS, L, LT,	614-638 MHz*
	M, N, NL, P, PL RO, S, SK, SLO, TR	614-638 MHz*
	All other countries	*
PSM300-M16 686 - 710 MHz max. 30 mW	A, B, BG, CH, CY, CZ, D, DK, EST, F,	686-710 MHz*
	FIN, GB, GR, H, HR, I, IRL, IS, L, LT,	686-710 MHz*
	M, N, NL, P, PL RO, S, SK, SLO, TR	686-710 MHz*
	All other countries	686-710 MHz*
PSM300-R12 794 - 806 MHz max. 10 mW	A, B, BG, CH, CY, CZ, D, DK, EST, F,	794-806 MHz*
	FIN, GB, GR, H, HR, I, IRL, IS, L, LT,	794-806 MHz*
	M, N, NL, P, PL RO, S, SK, SLO, TR	794-806 MHz*
	All other countries	*
PSM300-S8 823 - 832 MHz max. 20 mW	A, B, BG, CH, CY, CZ, D, DK, EST, F,	823-832 MHz*
	FIN, GB, GR, H, HR, I, IRL, IS, L, LT,	823-832 MHz*
	M, N, NL, P, PL RO, S, SK, SLO, TR	823-832 MHz*
	All other countries	823-832 MHz*
PSM300-T11 863 - 865 MHz max. 10 mW	EU member states license free	863-865 MHz
	CH, N, TR	863-865 MHz *
	All other countries	*
PS300-Q25 742 - 766 MHz max. 30 mW	A, B, BG, CH, CY, CZ, D, DK, EST, F,	742 - 766 MHz*
	FIN, GB, GR, H, HR, I, IRL, IS, L, LT,	742 - 766 MHz*
	M, N, NL, P, PL RO, S, SK, SLO, TR	742 - 766 MHz*
	All other countries	*

- * **NOTE:** This Radio equipment is intended for use in musical professional entertainment and similar applications. This Radio apparatus may be capable of operating on some frequencies not authorized in your region. Please contact your national authority to obtain information on authorized frequencies and RF power levels for wireless microphone products.
- * **REMARQUE :** Ce matériel radio est prévu pour une utilisation en spectacles musicaux professionnels et applications similaires. Il est possible que cet appareil radio soit capable de fonctionner sur certaines fréquences non autorisées localement. Se mettre en rapport avec les autorités compétentes pour obtenir les informations sur les fréquences et niveaux de puissance HF autorisés pour les systèmes de microphones sans fil.
- * **HINWEIS:** Diese Funkausrüstung ist zum Gebrauch bei professionellen Musikveranstaltungen und ähnlichen Anwendungen vorgesehen. Dieses Gerät kann möglicherweise auf einigen Funkfrequenzen arbeiten, die in Ihrem Gebiet nicht zugelassen sind. Wenden Sie sich bitte an die zuständige Behörde, um Informationen über zugelassene Frequenzen und erlaubte Sendeleistungen für drahtlose Mikrofonprodukte zu erhalten.
- * **NOTA:** Este equipo de radio está destinado para uso en presentaciones musicales profesionales y usos similares. Este aparato de radio puede ser capaz de funcionar en algunas frecuencias no autorizadas en su región. Por favor comuníquese con las autoridades nacionales para información sobre las frecuencias autorizadas y los niveles de potencia de radiofrecuencia para micrófonos inalámbricos.
- * **NOTA:** questo apparecchio radio è concepito per l'intrattenimento musicale a livello professionale ed applicazioni simili. Questo apparecchio radio può essere in grado di funzionare a frequenze non autorizzate nel Paese in cui si trova l'utente. Rivolgetevi alle autorità competenti per ottenere le informazioni relative alle frequenze ed ai livelli di potenza RF autorizzati nella vostra regione per i prodotti radiomicrofonici.
- * **OPMERKING:** Deze radioapparatuur is bedoeld voor gebruik bij professionele muzikale amusementsproducties en soortgelijke toepassingen. Dit radioapparaat kan mogelijk werken op bepaalde frequenties die niet zijn toegestaan in uw regio. Raadpleeg de autoriteiten in uw land voor informatie over goedgekeurde frequenties en RF-vermogensniveaus voor draadloze microfoons.
- * **ПРИМЕЧАНИЕ.** Данная радиоаппаратура предназначена для использования в профессиональных музыкальных представлениях и аналогичных приложениях. Может оказаться, что эта радиоаппаратура в состоянии работать на некоторых частотах, не разрешенных в вашем регионе. За информацией о разрешенных частотах и уровнях РЧ мощности для беспроводных микрофонных систем обращайтесь в национальные органы власти.

SHURE[®]
LEGENDARY
PERFORMANCE™

United States, Canada,
Latin America, Caribbean:
Shure Incorporated
5800 West Touhy Avenue
Niles, IL 60714-4608 USA

Phone: +1 847-600-2000
Fax: +1 847-600-1212 (USA)
Fax: +1 847-600-6446
Email: info@shure.com
www.shure.com

Europe, Middle East, Africa:
Shure Europe GmbH
Jakob-Dieffenbacher-Str. 12,
75031 Eppingen, Germany

Phone: +49-7262-92490
Fax: +49-7262-9249114
Email: info@shure.de
www.shure.eu

Asia, Pacific:
Shure Asia Limited
22/F, 625 King's Road
North Point, Island East
Hong Kong

Phone: +852-2893-4290
Fax: +852-2893-4055
Email: info@shure.com.hk
www.shureasia.com