

EW-D Smart Assist



Sennheiser Documentation App



or online at www.sennheiser.com/download



Evolution Wireless Digital

EW-D EM
 EW-D SK
 EW-D SKM-S

Quick Guide

Kurzanleitung
 Guide rapide
 Guida rapida
 Guía de inicio rápido
 Guia rápido
 Beknopte handleiding
 Krótka instrukcja obsługi
 Snabbguide

Kort vejledning

Pikaohje
 Γρήγορος οδηγός
 Kısa Kılavuz
 Краткая инструкция
 快速指南
 クイックガイド
 퀵 가이드

Sennheiser electronic GmbH & Co. KG

Am Labor 1, 30900 Wedemark, Germany
www.sennheiser.com

Printed in Germany
 Publ. 02/21, 583962/A02

SENNHEISER

EW-D Smart Assist

The **EW-D Smart Assist** app simplifies your workflow

- EW-D Smart Assist app provides automated setup, operation and monitoring using any iOS or Android device
- Intelligent setup automatically creates reliable wireless connections, no wireless expertise required
- Mobile access to all system settings centralizes control and eliminates the need for complicated menu navigation on each device
- Easy frequency allocation and wireless channel naming help to keep systems organized



In the box

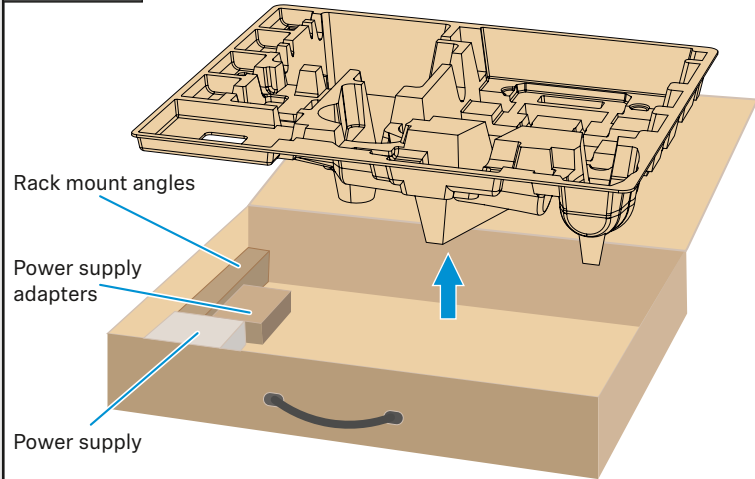

EW-D EM

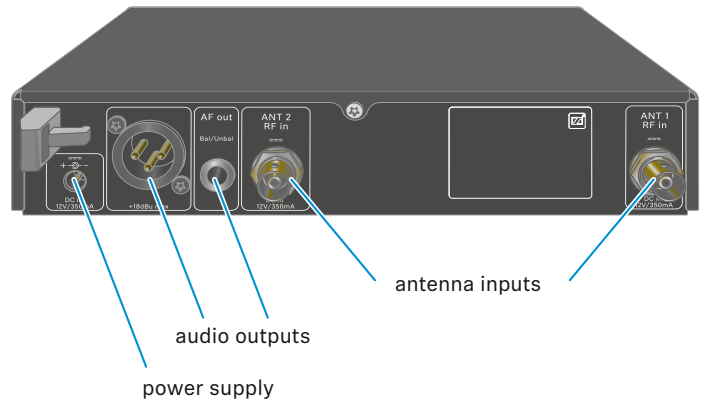
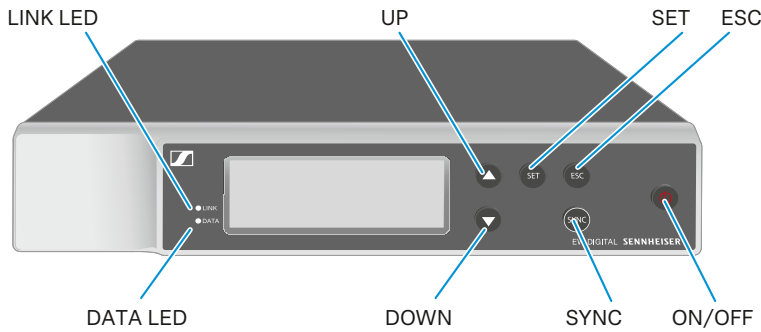

EW-D SKM-S

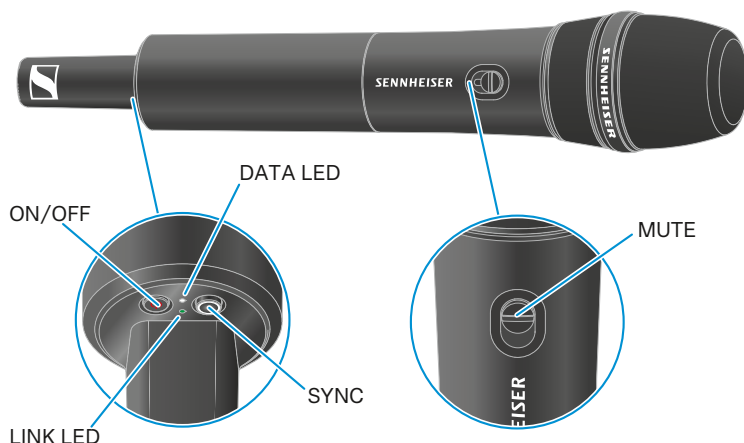

EW-D SK

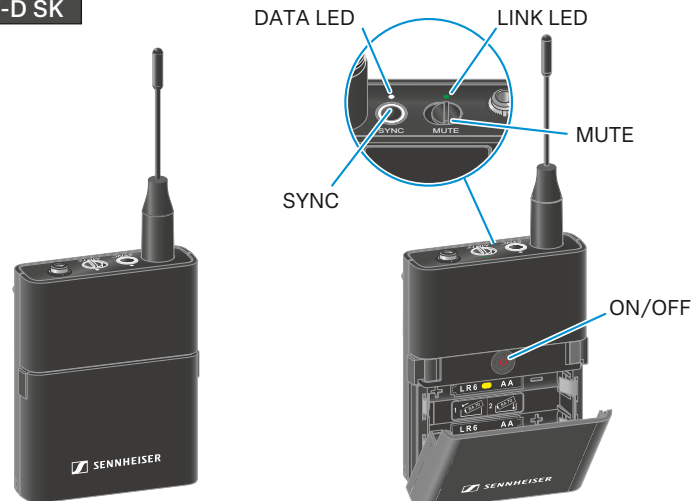

Display

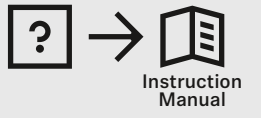
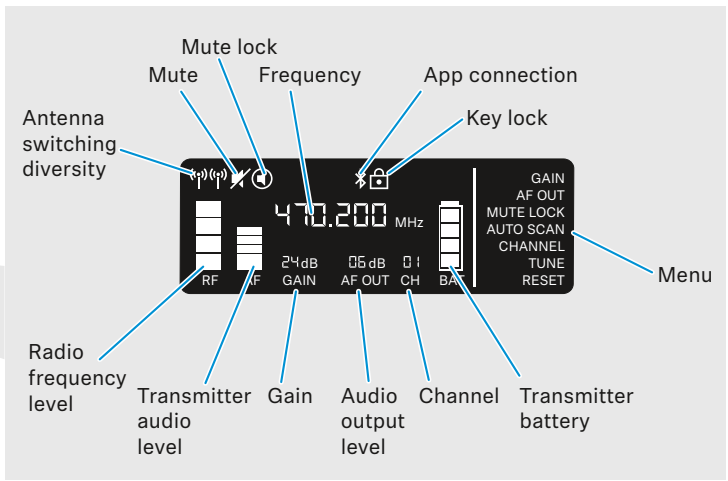
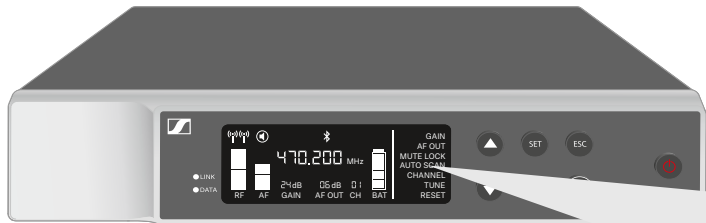

Menu

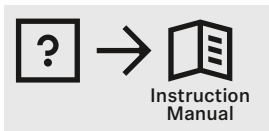
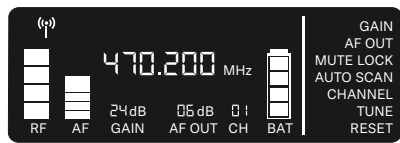

Gain

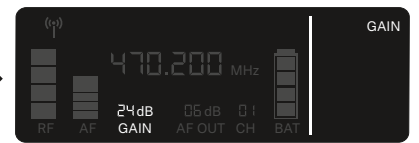

AF Out



Mute Lock

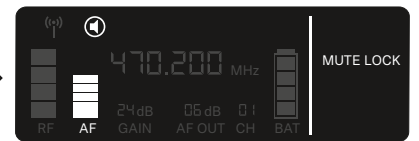

Auto Scan

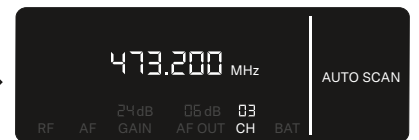
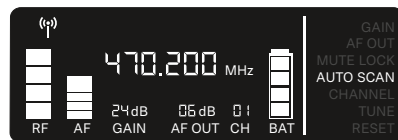

Channel

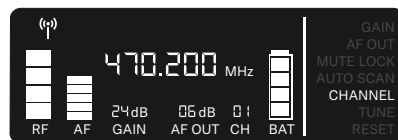

Tune

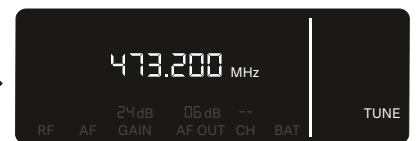
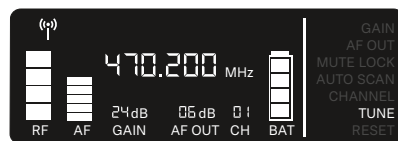

Reset

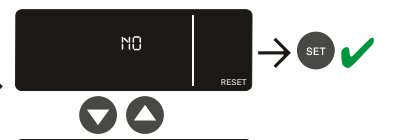
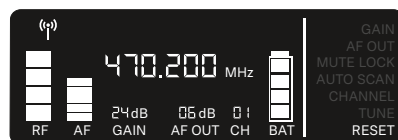

Instruction manual | Bedienungsanleitung |
 Notice d'emploi | Istruzioni per l'uso |
 Instrucciones de manejo | Manual de
 instruções | Gebruiksaanwijzing |
 Instrukcja obsługi | Bruksanvisning |
 Betjenings vejledning | Käyttöohje |
 Οδηγίες λειτουργίας | Kullanım kılavuzu |
 Инструкция по эксплуатации | 使用说明书 |
 取扱説明書 | 사용 설명서 |

EW-D Smart Assist



Sennheiser Documentation App



Antennas

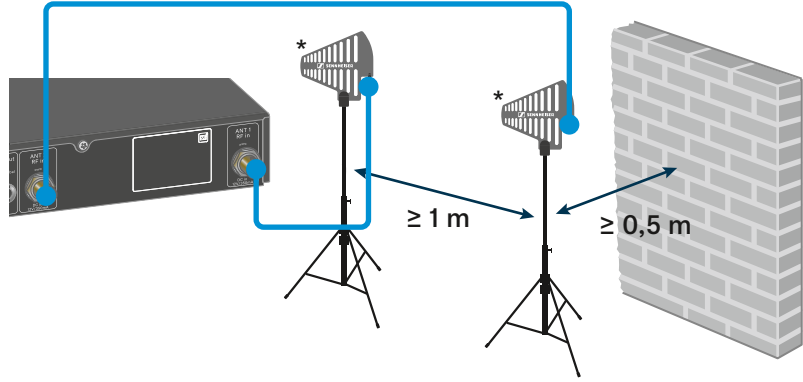
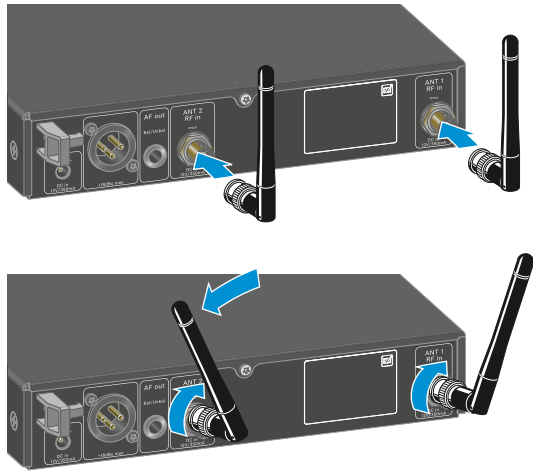

*optional accessories:
ADP UHF (470 - 1075 MHz)
AD 1800 (1400 - 2400 MHz)

Audio Out

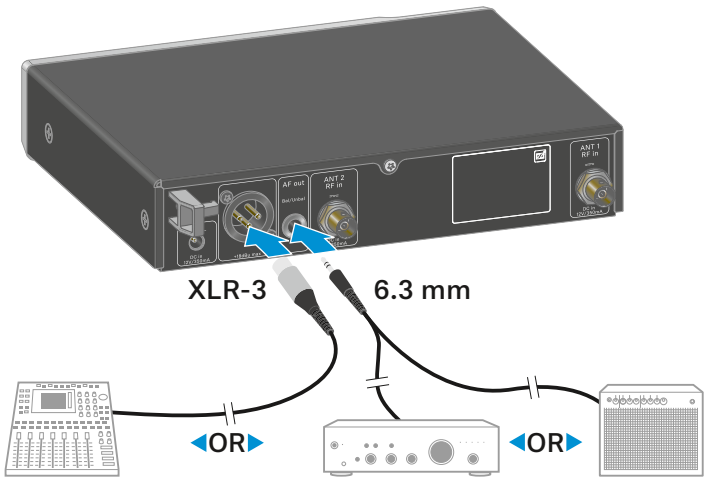

Power supply

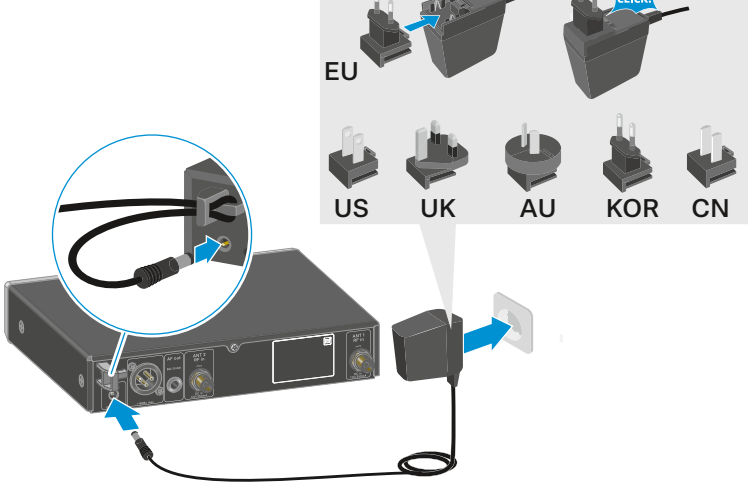

Battery

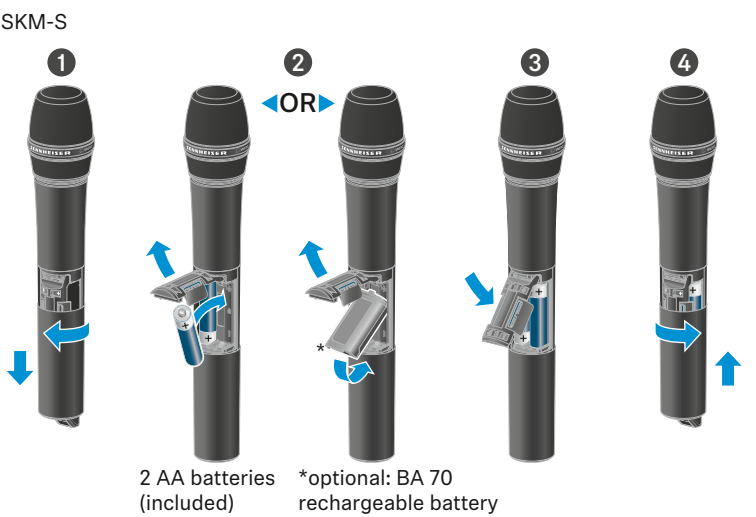
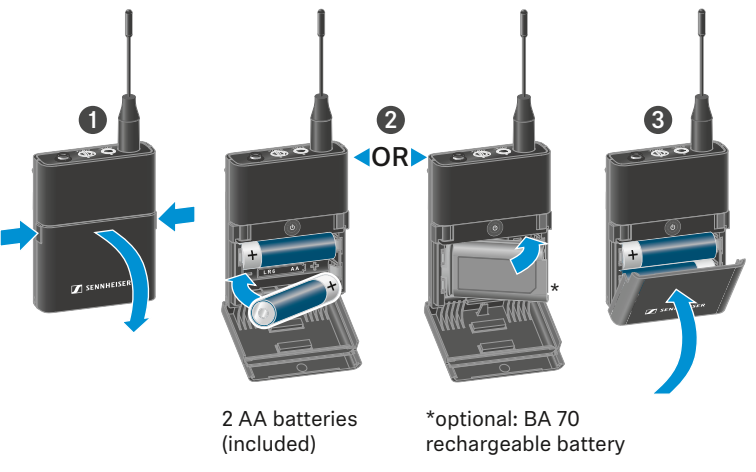

On/Off

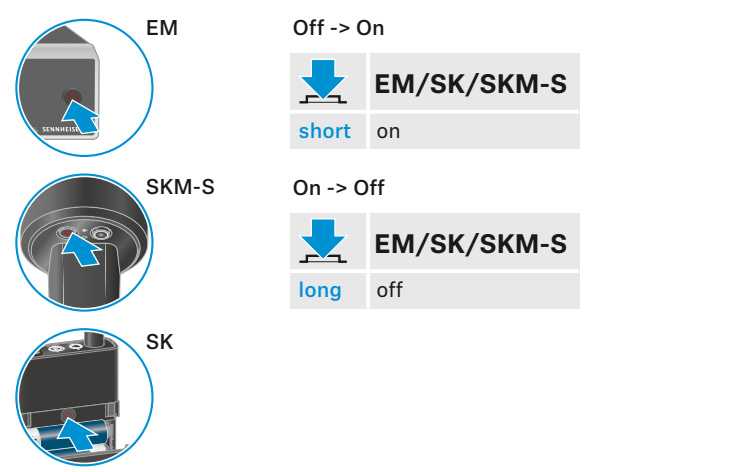

Identify/Battery check

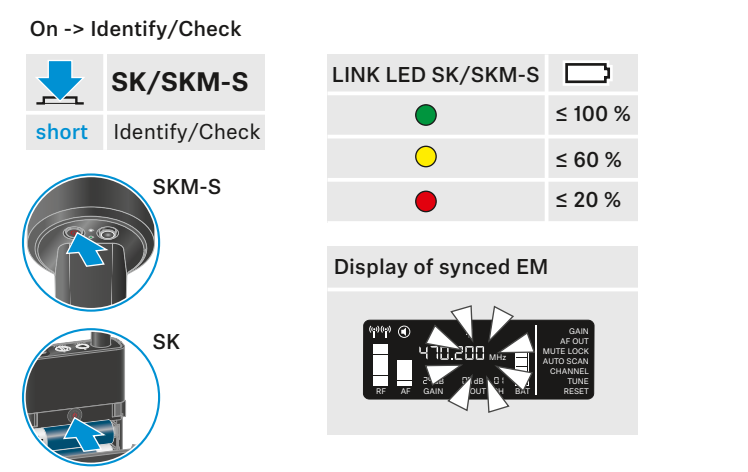

LEDs

LINK LED	
	- Link ok - audio active
	- Link ok - audio muted or no capsule on SKM
	- Link ok - audio clip
	- No link
	- Link ok - Low transmitter battery
	- No link - Device switched off

DATA LED	
	Bluetooth active to - sync with transmitter - connect with app
	Firmware update in progress

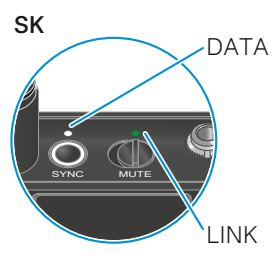
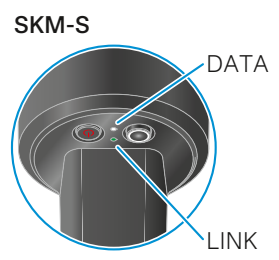
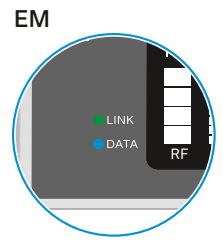
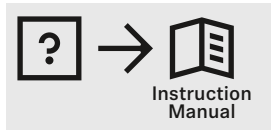

Sync

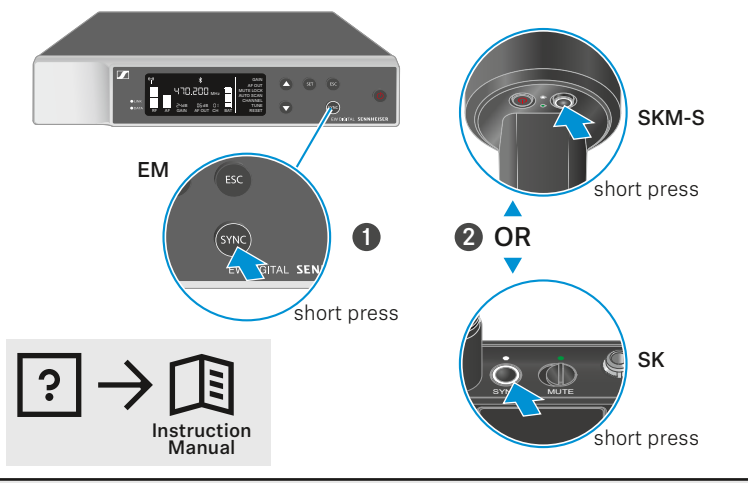

Key lock

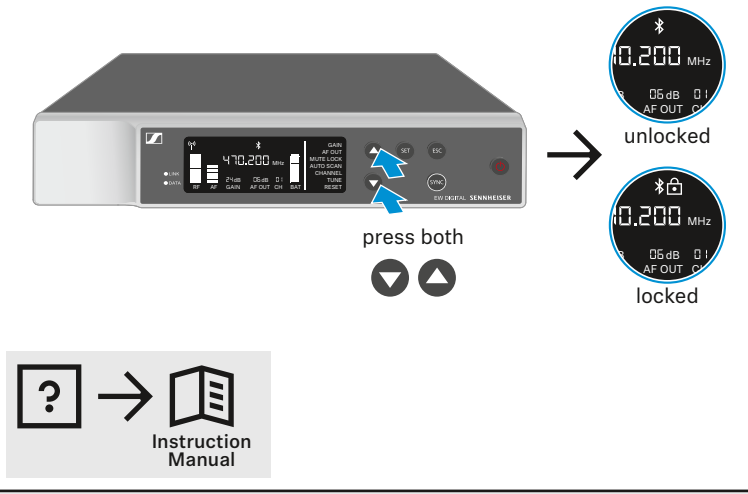

Mute

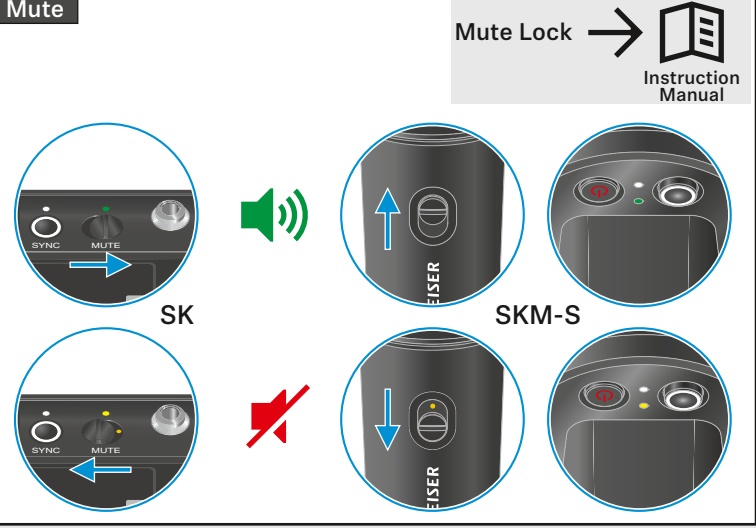

Color coding sets

