

CXD Amplifiers



User Manual

CXD4.2 – 4 Channel, 2000 W Amplifier

CXD4.3 – 4 Channel, 4000 W Amplifier

CXD4.5 – 4 Channel, 8000 W Amplifier

TD-000367-01-B



EXPLANATION OF SYMBOLS

The term "**WARNING!**" indicates instructions regarding personal safety. If the instructions are not followed the result may be bodily injury or death.

The term "**CAUTION!**" indicates instructions regarding possible damage to physical equipment. If these instructions are not followed, it may result in damage to the equipment that may not be covered under the warranty.

The term "**IMPORTANT!**" indicates instructions or information that are vital to the successful completion of the procedure.

The term "**NOTE**" is used to indicate additional useful information.



The intent of the lightning flash with arrowhead symbol in a triangle is to alert the user to the presence of un-insulated "dangerous" voltage within the product's enclosure that may be of sufficient magnitude to constitute a risk of electric shock to humans.



The intent of the exclamation point within an equilateral triangle is to alert the user to the presence of important safety, and operating and maintenance instructions in this manual.



IMPORTANT SAFETY INSTRUCTIONS



WARNING!: TO PREVENT FIRE OR ELECTRIC SHOCK, DO NOT EXPOSE THIS EQUIPMENT TO RAIN OR MOISTURE.

1. Read these instructions.
2. Keep these instructions.
3. Heed all warnings.
4. Follow all instructions.
5. Do not use this apparatus near water.
6. Clean only with a dry cloth.
7. Do not block any ventilation opening. Install in accordance with the manufacturer's instructions.
8. Do not install near any heat sources such as radiators, heat registers, stoves, or other apparatus (including amplifiers) that produce heat.
9. Do not defeat the safety purpose of the polarized or grounding-type plug. A polarized plug has two blades with one wider than the other. A grounding type plug has two blades and a third grounding prong. The wide blade or the third prong are provided for your safety. If the provided plug does not fit into your outlet, consult an electrician for replacement of the obsolete outlet.
10. To reduce the risk of electrical shock, the power cord shall be connected to a mains socket outlet with a protective earthing connection.
11. The appliance coupler, or the AC Mains plug, is the AC mains disconnect device and shall remain readily operable after installation.
12. Protect the power cord from being walked on or pinched particularly at plugs, convenience receptacles, and the point where they exit from the apparatus.
13. Only use attachments/accessories specified by the manufacturer.
14. Unplug this apparatus during lightning storms or when unused for long periods of time.
15. Refer all servicing to qualified service personnel. Servicing is required when the apparatus has been damaged in any way, such as power-supply cord or plug is damaged, liquid has been spilled or objects have fallen into the apparatus, the apparatus has been exposed to rain or moisture, does not operate normally, or has been dropped.
16. Adhere to all applicable, local codes.
17. Consult a licensed, professional engineer when any doubt or questions arise regarding a physical equipment installation.
18. Do not use any aerosol spray, cleaner, disinfectant or fumigant on, near or into the apparatus. Clean only with a dry cloth.
19. Do not unplug the unit by pulling on the cord, use the plug.
20. Do not submerge the apparatus in water or liquids.
21. Keep ventilation opening free of dust or other matter.

Maintenance and Repair



WARNING! Advanced technology, e.g., the use of modern materials and powerful electronics, requires specially adapted maintenance and repair methods. To avoid a danger of subsequent damage to the apparatus, injuries to persons and/or the creation of additional safety hazards, all maintenance or repair work on the apparatus should be performed only by a QSC authorized service station or an authorized QSC International Distributor. QSC is not responsible for any injury, harm or related damages arising from any failure of the customer, owner or user of the apparatus to facilitate those repairs.

FCC Statement

For CXD4.3 and CXD4.5



NOTE: This equipment has been tested and found to comply with the limits for a Class A digital device, pursuant to Part 15 of the FCC Rules. These limits are designed to provide reasonable protection against harmful interference when the equipment is operated in a commercial environment. This equipment generates, uses, and can radiate radio frequency energy and, if not installed and used in accordance with the instruction manual, may cause harmful interference to radio communications. Operation of this equipment in a residential area is likely to cause harmful interference in which case the user will be required to correct the interference at his own expense.

For CXD4.2



NOTE: This equipment has been tested and found to comply with the limits for a Class B digital device, pursuant to Part 15 of the FCC Rules.

These limits are designed to provide reasonable protection against harmful interference in a residential installation. This equipment generates, uses and can radiate radio frequency energy and, if not installed and used in accordance with the instructions, may cause harmful interference to radio communications. However, there is no guarantee that interference will not occur in a particular installation. If this equipment does cause harmful interference to radio or television reception, which can be determined by turning the equipment off and on, the user is encouraged to try to correct the interference by one or more of the following measures:

- Reorient or relocate the receiving antenna.
- Increase the separation between the equipment and receiver.
- Connect the equipment into an outlet on a circuit different from that to which the receiver is connected.
- Consult the dealer or an experienced radio/TV technician for help.

RoHS STATEMENT

The QSC CXD4.2, CXD4.3 and CXD4.5 amplifiers are in compliance with European Directive 2011/65/EU – Restriction of Hazardous Substances (RoHS2).

The QSC CXD4.2, CXD4.3 and CXD4.5 amplifiers are in compliance with “China RoHS” directives. The following chart is provided for product use in China and its territories:

部件名称 (Part Name)	QSC CXD4.2, CXD4.3, and CXD4.5 Amplifiers					
	有毒有害物质或元素 (Toxic or hazardous Substances and Elements)					
	铅 (Pb)	汞 (Hg)	镉 (Cd)	六价铬 (Cr(vi))	多溴联苯 (PBB)	多溴二苯醚 (PBDE)
电路板组件 (PCB Assemblies)	X	0	0	0	0	0
机壳装配件 (Chassis Assemblies)	X	0	0	0	0	0

O: 表明这些有毒或有害物质在部件使用的同类材料中的含量是在 SJ/T11363_2006 极限的要求之下。
(O: Indicates that this toxic or hazardous substance contained in all of the homogeneous materials for this part is below the limit requirement in SJ/T11363_2006.)

X: 表明这些有毒或有害物质在部件使用的同类材料中至少有一种含量是在 SJ/T11363_2006 极限的要求之上。
(X: Indicates that this toxic or hazardous substance contained in at least one of the homogeneous materials used for this part is above the limit requirement in SJ/T11363_2006.)

Warranty

For a copy of the CXD warranty, visit the QSC website at www.qsc.com

Introduction

Built for system integrators, the CXD series amplifiers provide multi-channel amplification with built-in DSP and enough power to drive wide varieties of speaker systems with optimal energy efficiency. The CXD Series consists of three light-weight, 2RU, four-channel amplifiers with on-board DSP and flexible channel combining as well as 70V and 100V direct drive. These amplifiers not only provide the power and processing to make your system perform better, they offer outstanding efficiency ensuring that energy costs are kept to a minimum over the life of the installation.

CXD amplifiers feature Flexible Amplifier Summing Technology (FAST). Depending on the model, 2000, 4000, or 8000 Watts of total power can be distributed across one to four outputs. In addition, the CXD4.3 and CXD4.5, can drive 70V or 100V speaker lines directly from any one or all of the four outputs, and the CXD4.2 can drive 70V or 100V speaker outputs from bridged channels. This flexibility allows CXD Series amplifiers to drive (for example) two full-range, surface-mounted loudspeakers along with a subwoofer and one 100 V distributed loudspeaker line; or a high-power subwoofer and a bi-amplified full-range loudspeaker; three 70V distributed loudspeaker lines and a subwoofer; or a single very high-power channel to drive monster subwoofers.

The CXD Series amplifiers use QSC's third-generation class-D power amp design in combination with a custom power stage utilizing a new output device (4.3 and 4.5 only). In addition, CXD amplifiers employ the proven PowerLight power supply in conjunction with Power Factor Correction (PFC) (4.3 and 4.5 only) which aligns the current waveform with the AC mains voltage waveform. PFC enables the CXD Series amplifiers to draw current from the wall in a more efficient and controlled manner resulting in very high power from a single standard AC breaker. Additionally, the CXD Series amplifiers offer multi-stage sleep modes saving energy when possible without sacrificing performance. The result is an exceptionally powerful and flexible platform that offers very high efficiency.

With four channels of amplification plus signal processing in just 2RUs, the CXD series replaces equipment taking up as much as three times the rack-space.

A single CXD Series amplifier is a capable and sophisticated loudspeaker processor. Integration of processing and amplification means that the DSP knows exactly what the amplifier is doing so dynamics processing can be far more accurate and effective. This approach employs both RMS and Peak Limiters that allow the amplifier and loudspeaker to produce more output without being pushed to distortion or destruction.

The on-board DSP offers four channels of cross-over filters, 5-band parametric EQ/Low-shelf/High-shelf, alignment delay and dynamics processing – everything needed to optimize a loudspeaker system. Additionally when using QSC loudspeakers, CXD amplifiers provide Intrinsic Correction™, a combination of filtering, limiting and loudspeaker knowhow that was first developed for QSC's WideLine line-array loudspeakers. Intrinsic Correction compensates for the non-linearity in horn and driver design resulting in exceptional performance.

The CXD also includes manufacturers' recommended tunings for a number of the most popular passive loudspeakers. A system setup wizard helps you select the right preset, or select one of the 20 configuration templates and create tunings that you can save in the user preset library.

Whether using the dedicated front panel user interface featuring a 400 x 240 display, rotary encoder and navigation buttons, or the Amplifier Navigator software on a PC or Mac, the CXD amplifiers are an ideal amplifier/processing platform for installations.

Unpacking

There are no special unpacking instructions. You may want to keep the shipping material for the unlikely event that the amplifier should need returning for service.

Package Contents

1. Quick-Start Guide TD-000350
2. Warning Information Sheet TD-000420
3. CXD Amplifier
4. IEC AC Power Cord
5. Euro-style Connector Plug, 3-pin (4)
6. Euro-style Connector Plug, 8-pin (1)
7. Euro-style Connector Plug, 3.5 mm, 2-pin (1)
8. Euro-style Connector Plug, 3.5 mm, 3-pin (1)
9. USB Cable (1)

Features

Amplifier Front Panel

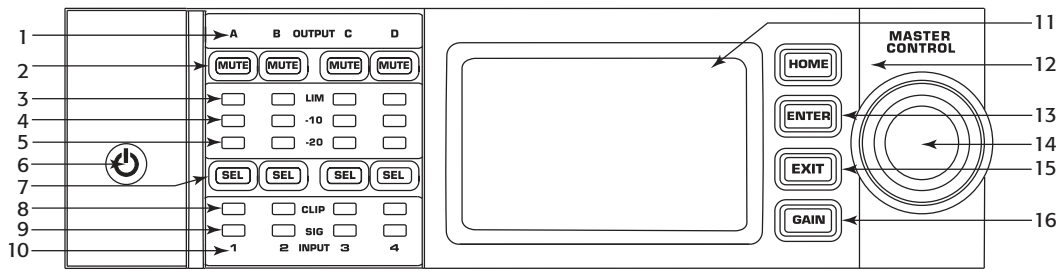

– Figure 1 –

- | | |
|---|---|
| 1. Output channels are labeled A, B, C, and D | 9. Input Channel Signal-Present LEDs (Blue) |
| 2. Output Channel Mute Buttons and LEDs (Red) | 10. Input channels are labeled 1, 2, 3, and 4 |
| 3. Output Channel Limiter LEDs (Red) | 11. LCD Graphic Display |
| 4. Output Channel -10 dB below maximum amplifier output (Blue) | 12. HOME Button |
| 5. Output Channel -20 dB below maximum amplifier output (Blue) | 13. ENTER Button |
| 6. Soft Power Button (Blue/Red) | 14. MASTER CONTROL Knob |
| 7. Channel Select Buttons and LEDs (Amber for Input, Blue for Output) | 15. EXIT Button |
| 8. Input Channel Clip LEDs (Red) | 16. GAIN Button |

Amplifier Rear Panel



NOTE: The CXD4.3, and CXD4.5 models have a different rear panel configuration than the CXD4.2 rear panel. The difference is that the position of the fan and the eight-pin Euro-style connector and associated information are interchanged.

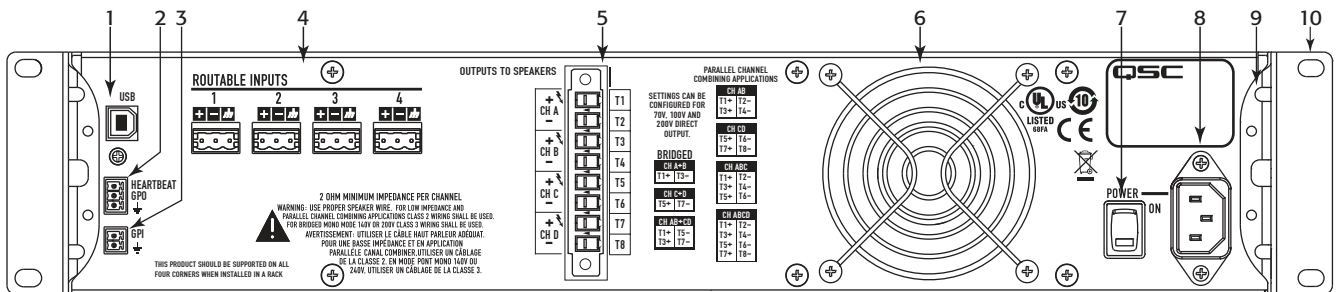

– Figure 2 –

- | | |
|---|---------------------------------|
| 1. USB Type B, four-pin | 6. Cooling fan |
| 2. GPO/Heartbeat (output) Euro-style Connector, 3-pin | 7. AC Power Switch |
| 3. GPI (input) Euro-style Connector, 2-pin | 8. Locking IEC Power Connection |
| 4. Four three-pin Euro-style Connectors | 9. Rear Rack-mount Bracket |
| 5. One eight-pin Euro-style Loudspeaker Connector | 10. Front Rack-mount Brackets |

Installation

The following steps are written in the recommended installation order.

Rack-Mount the Amplifier

The CXD Series amplifiers are designed to be mounted in a standard rack-mount unit. The amplifiers are 2RU high, the CXD4.3 and CXD4.5 are 381 mm (15 in) deep, the CXD4.2 is 229 mm (9 in) deep.

1. Secure the amplifier in the rack with eight (four for the CXD4.2) screws (not included), four in front, four in back. For complete instructions, refer to TD-000050 "Rear Rack Ears Installation Guide" which can be found on the QSC Website (www.qsc.com).



CAUTION! Be sure that nothing is blocking the front or rear ventilation openings, and that each side has a minimum of 2 cm clearance.

AC Mains



WARNING! When the AC Power is on, there is a potential of having dangerous voltage at the output terminals on the rear of the amplifier. Use caution not to touch these contacts. Turn off the AC Mains disconnect switch prior to making any connections.

The CXD4.3 and CXD4.5 amplifiers have a Universal power supply 100 – 240 VAC, 50 – 60 Hz, with an IEC locking connector. The CXD 4.2 has a Universal power supply 100 - 132/200-240 VAC, 50 – 60 Hz, with an IEC locking connector.

1. Make sure the power switch on the rear of the amplifier is off.
2. Connect the IEC AC cable between the amplifier rear AC connector and the AC source.

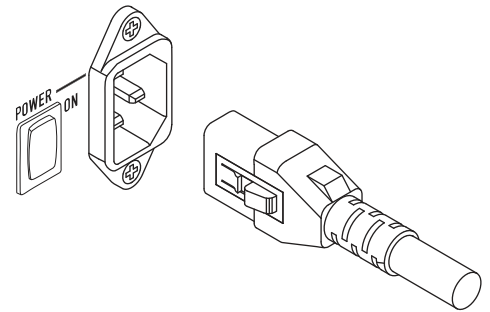

– Figure 3 –

AC Power



NOTE: If the amplifier has no audio for fifteen minutes, the amplifier stops switching. The amplifier returns to the Run mode the instant audio is present.

When you remove power from the amplifier, then re-apply the power, the amplifier returns to its last state.

Inputs

Connect the Audio Inputs

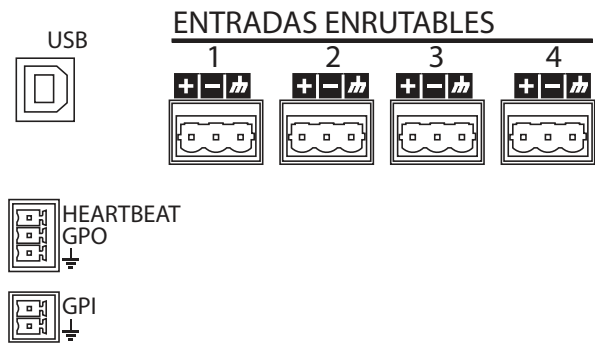
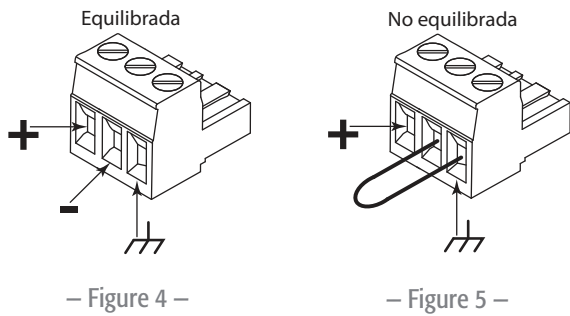

There are four three-pin Euro-style connectors labeled 1 through 4 providing the audio inputs on the CXD Amplifiers. A single input can be mixed to one or a combination of outputs. You can use from one to four of the inputs. The inputs are 10 kΩ balanced or unbalanced, with a sensitivity of either +4 or +14 dBu.

1. Make sure your audio source devices are powered off.
2. Wire the audio line-level source to up to four Euro-style connectors (supplied). You may use either balanced inputs (Figure 4) or unbalanced inputs (Figure 5).



NOTE: The CXD Series has the capability of routing the inputs to different outputs. Be sure that the connections you make here match the configuration of the amplifier.

3. Plug the connectors into the appropriate receptacles (ROUTABLE INPUTS 1, 2, 3, 4) Figure 6 and Figure 7.

USB (Optional)

The USB cable (supplied) connects to a Mac or PC for use with the Amplifier Navigator software. You can update the amplifier firmware, save and deploy configuration files, and more. Refer to the Amplifier Navigator online help for details.

GPIO/Heartbeat

There are two 3.5 mm Euro-style connectors on the rear of the amplifier.

- Heartbeat – The heartbeat output supplies a square wave signal of 1 Hz @ 3.3 V. This signal can connect to a life-safety system to monitor the go/no-go condition of the amplifier. The amplifier must be completely incapable of producing output for the heartbeat signal to stop. A missing heartbeat alerts the life-safety system of the disabled condition. A user-initiated condition such as muting the outputs, placing the amplifier in Standby mode, or placing the amplifier in Mute All mode, does not stop the heartbeat.
- GPO – The GPO can be triggered (High or Low flag) by one of the following faults:
 - All Faults
 - Thermal Limiting
 - Impedance (selectable impedance boundaries)
- GPI – The GPI Input allows you to do one of the following from a remote location:
 - Put the amplifier into Standby or Run mode,
 - Mute or unmute all outputs, or
 - Recall one of two Presets

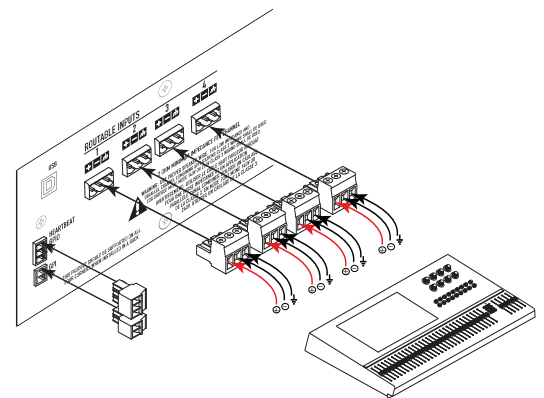

Outputs

The CXD amplifiers have four configurable outputs. You can set the power, combine outputs (bridged and parallel), and adjust the DSP for each output. When the output configuration of the amplifier changes, the output terminals, controlled by relays, change accordingly. Use the diagrams shown in Figure 9 thru Figure 17 as a reference for wiring the loudspeakers.

Select the Output Configuration

The first step in configuring your amplifier is to select a Preset based on the loudspeakers being connected to the amplifier. The Preset Name is representative of the configuration. You can select a factory preset, and then adjust the parameters as needed, then save the configuration as a user-defined preset. In addition, you can use the "Preset Wizard" on page 15 to create presets from one of the basic channel combinations. When the configuration is changed, all four channels are automatically muted.

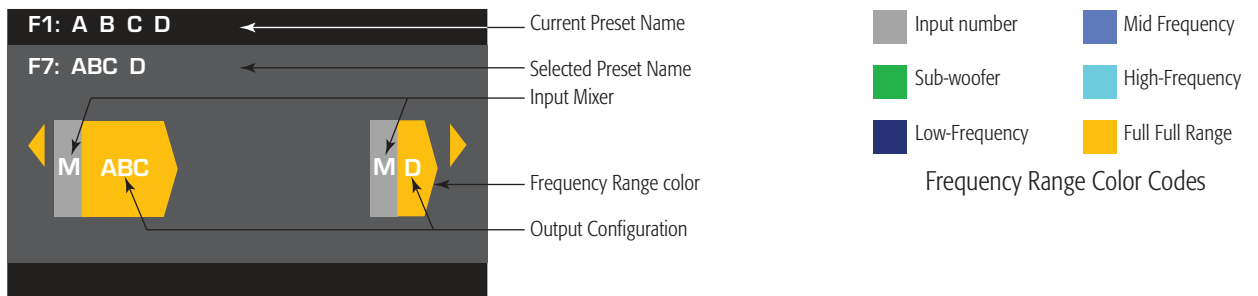

– Figure 8 –



WARNING!: When the AC Power is on, there is a potential of having dangerous voltage at the output terminals on the rear of the amplifier. Use caution not to touch these contacts. Turn off the AC Mains disconnect switch prior to making any connections.

1. Turn the AC Mains power switch on the back of the amplifier to on. The amplifier starts in the Run mode.
2. Press and release the front-panel power button. The button flashes red, the amplifier is in Mute All mode.
3. Select the configuration appropriate for your loudspeakers, using either Preset Recall, or the Preset Wizard.

The following is a list of configurations for 1, 2, 3, and 4-channel outputs. This is not an exhaustive list, but is intended to give you an idea of what is available and how the outputs would be wired.

One-Channel Configurations

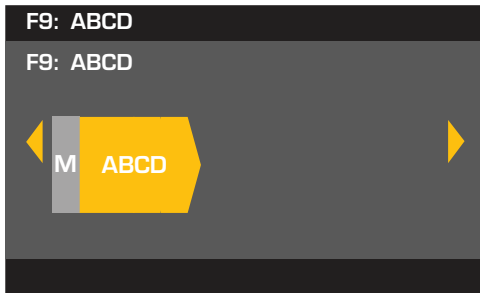

ABCD Parallel

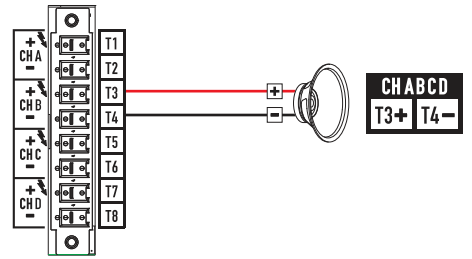

– Figure 9 –

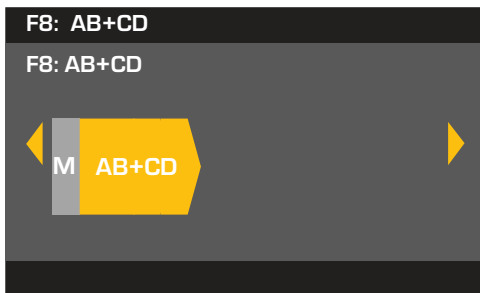

AB Parallel
Bridged with
CD Parallel

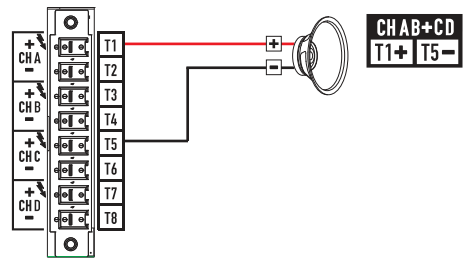

– Figure 10 –

Two-Channel Configurations

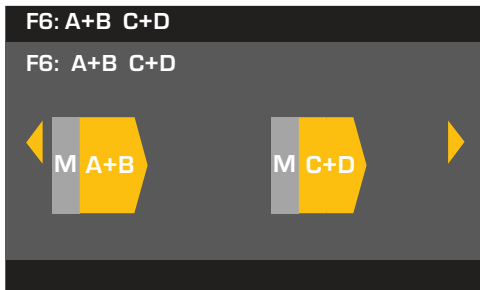

A+B Bridged
C+D Bridged

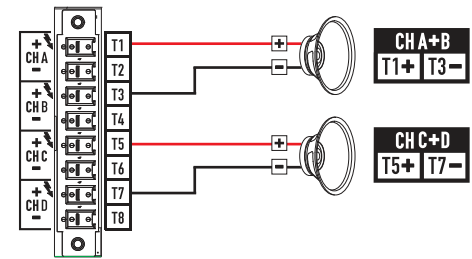

– Figure 11 –

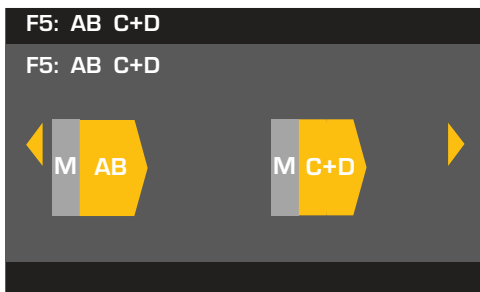

AB Parallel
C+D Bridged

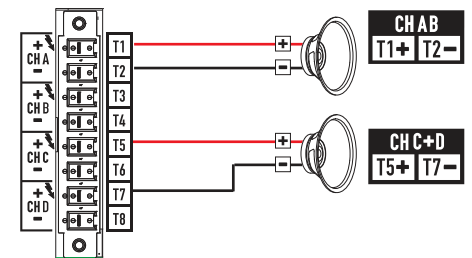

– Figure 12 –



AB Parallel
CD Parallel

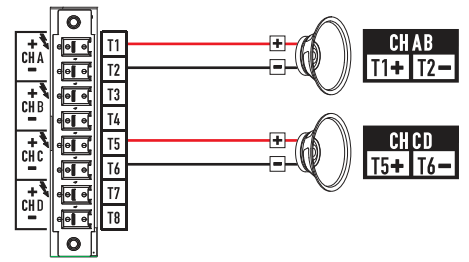

– Figure 13 –

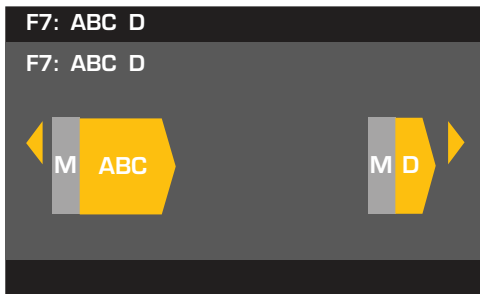

ABC Parallel
D Single

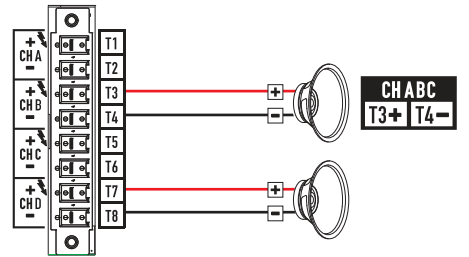

– Figure 14 –

Three-Channel Configurations

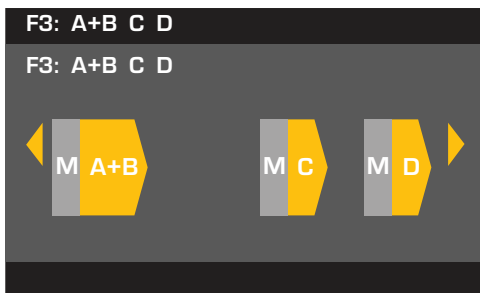

A+B Bridged
C Single
D Single

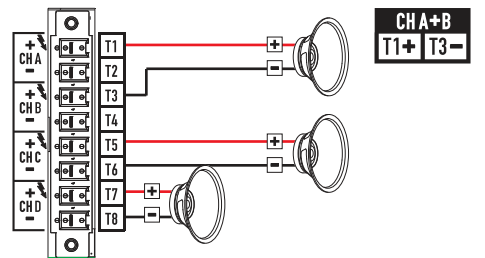

– Figure 15 –

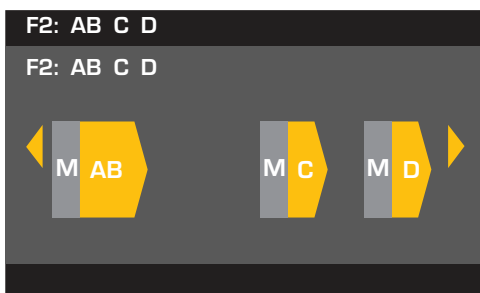

AB Parallel
C Single
D Single

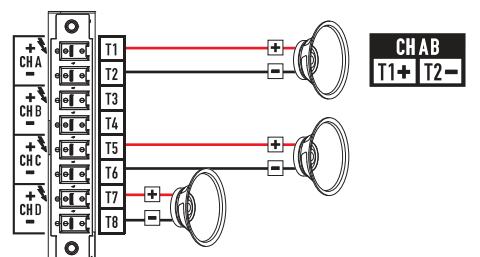

– Figure 16 –

Four-Channel Configuration

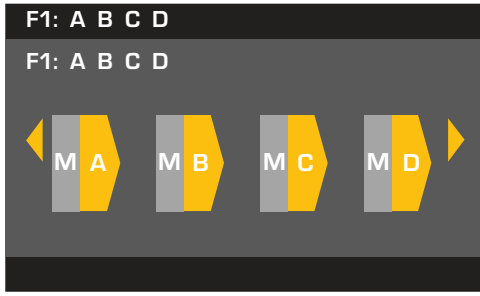

A Single
B Single
C Single
D Single

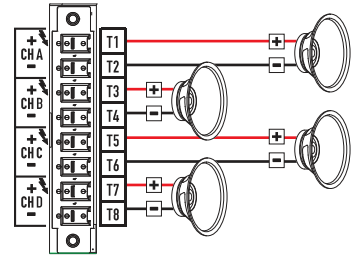

– Figure 17 –

Connect the Loudspeakers



WARNING! When the AC Power is on, there is a potential of having dangerous voltage at the output terminals on the rear of the amplifier. Use caution to not touch these contacts. Turn off the AC Mains disconnect switch prior to making any connections.

1. Turn the AC Mains power switch, on the back of the amplifier, to OFF.
2. Connect the loudspeaker wiring to the 8-pin Euro-style connector. Refer to Figure 9 thru Figure 17.
3. Install the Euro-style connector onto the rear of the amplifier as shown in Figure 18.
4. Use a Phillips screwdriver to secure the connector.

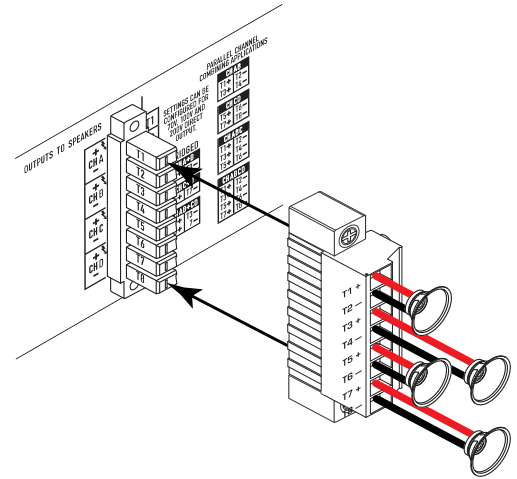

– Figure 18 –

Amplifier Control

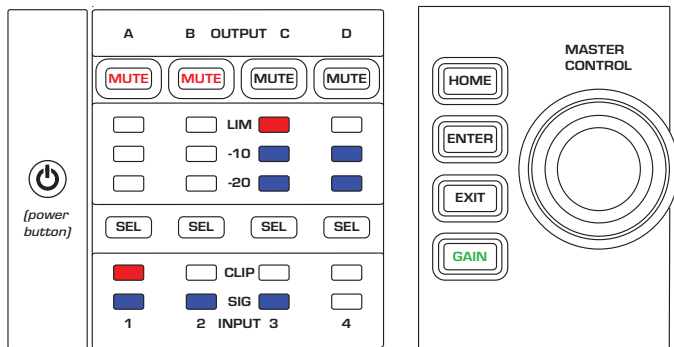

– Figure 19 –

Off Mode

- Rear *power switch* is off, the amplifier is not operable. The *power switch* is the AC Mains disconnect.
- The power button is not illuminated.
- Turn the *power switch* to on. The amplifier enters the mode it was in when power was removed. The power button is illuminated based on the mode.
- GPI setup has an effect on the operation of the power button.



Run Mode

- From Standby or Mute All modes, press and release the power button on the front panel.
- The power button is illuminated blue.
- The amplifier is fully operable; audio can pass.
- GPI setup has an effect on the operation of the power button.



Standby Mode

- From Mute All or Run modes, press and hold the power button on the front panel for two to three seconds.
- The power button illuminates solid red.
- The front panel LCD is off.
- The amplifier is not operable; audio will not pass.
- GPI setup has an effect on the operation of the power button.



Mute All Mode

- From the Run Mode, quickly press and release the power button.
- The power button flashes red.
- The outputs are muted and amplifiers are off.
- The front panel and DSP functionality are fully operable. Any changes you make are saved and take effect in the Run Mode.
- GPI setup has an effect on the operation of the power button.



Master Control Knob

- Scrolls up/down and right/left to select menu items and parameters
- Adjusts parameters



ENTER Button

- Navigates into the menu structure
- Enters the edit mode for adjusting parameters
- Confirms the changes you make, and exits the edit mode.



EXIT Button

- Navigates out of the menu structure and parameter selection.
- In the edit mode, pressing EXIT reverts the value back to its prior state, and exits the edit mode.



HOME Button

- If you are on the Home screen, pressing HOME displays the alternate Home screen. Pressing HOME again returns you to the primary Home screen.
- If you are on a navigation screen, pressing HOME takes you to the home screen.
- If you are on an edit screen, pressing HOME will confirm any value being edited and take you to the Home screen.



GAIN Button

- Pressing the GAIN button from any screen takes you to the output gain screen for the most recently accessed output channel.
- Pressing GAIN again confirms the gain change and returns to the screen you were on when you pressed GAIN.
- The Gain button illuminates green when selected.



SEL Buttons

- Use these buttons to navigate between input channels or output channels. For example, if you are adjusting output gain on channel A, pressing the channel B SEL button takes you to the gain adjustment for channel B.
- These buttons change both Input and Output selection at the same time. For example, if you select Output A then switch to an Input screen, you are on Input 1.
- The SEL buttons are active on any Input or Output screen as indicated by an illuminated SEL button, and a label in the upper right corner of the screen (Input 1-4 or Output 1-4).
- The SEL buttons illuminate blue for output channels, and amber for input channels.



MUTE Buttons

- Use these buttons to mute the audio of the associated output channel.
- When the output configuration is changed, the MUTE buttons are engaged automatically. You must manually unmute the channels.



LIM LEDs

- Illuminates red when the Limiter is engaged.



-10 and -20 LEDs

- Indicates the dB below maximum output level of the channel.



CLIP LEDs

- Illuminates red when the input signal is being clipped.



SIG LEDs

- Illuminates blue when a signal greater than -40 dB is present.



CXD Amplifier Signal Flow

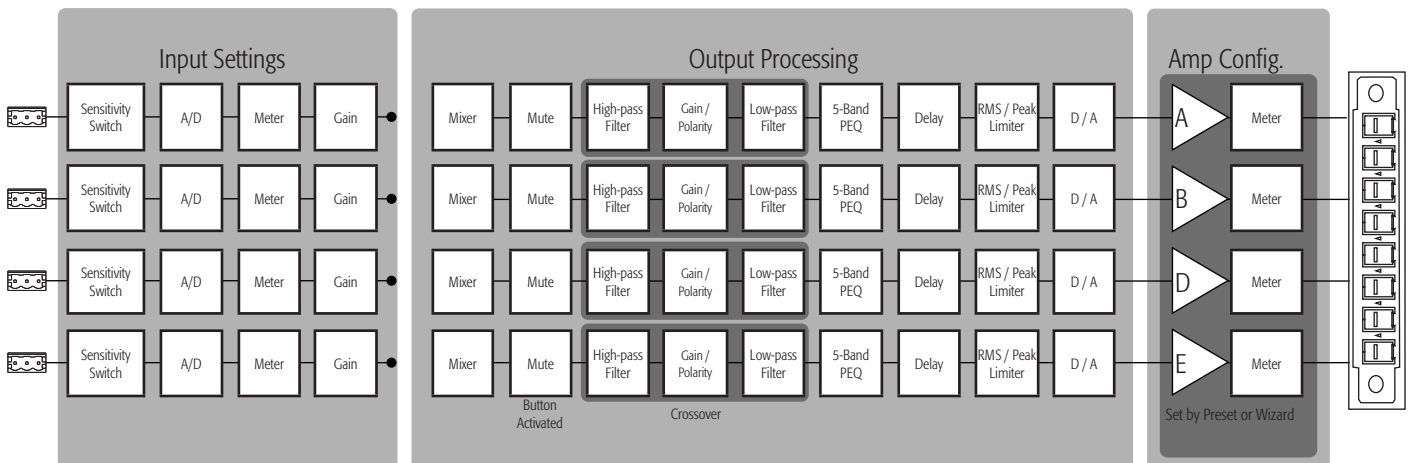

– Figure 20 –

Menu Tree

Presets

- Preset Recall
- Preset Save
- Preset Wizard

Inputs

- Input Sensitivity
- Input Gain

Outputs

- Mixer w/Noise & Tone
- Mode (Lo-Z, 70V, 100V)
- Spkr Processing
 - Crossover
 - PEQ
 - Delay
 - Limiter
 - Array Correction*
 - Load Speaker
 - Save Speaker

Utilities

- Status
- Amp ID
- Display
- Lockout
- Password
- GPI
- GPO

*For QSC Line Arrays only.

AC Power On

After connecting the outputs to the loudspeakers, you may turn the amplifier on.

1. Make sure the output gain settings for all audio-source devices (CD Players, Mixers, Instruments, etc.) are at the lowest output (max attenuation).
2. Turn on all audio sources.
3. Turn the AC Mains power switch on the back of the amplifier to ON. The amplifier starts in the state it was in when power was removed. If the amplifier is in Standby or Mute All mode (Power button LED solid red or blinking), press the Power button to change the amplifier to Run mode.
4. You can now bring up the outputs of your audio sources.

Screen Types

Informational

Informational screens, like the HOME screen, are designed to provide you with a good amount of useful information at a glance.

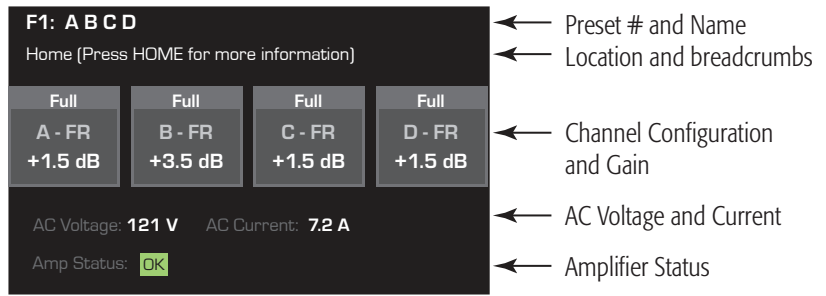

– Figure 21 –

Navigational

Navigational screens provide the means to move around and select menu items. Use the Master Control knob, ENTER and EXIT buttons for navigation. This is an example of one type of navigational screen, there are others.

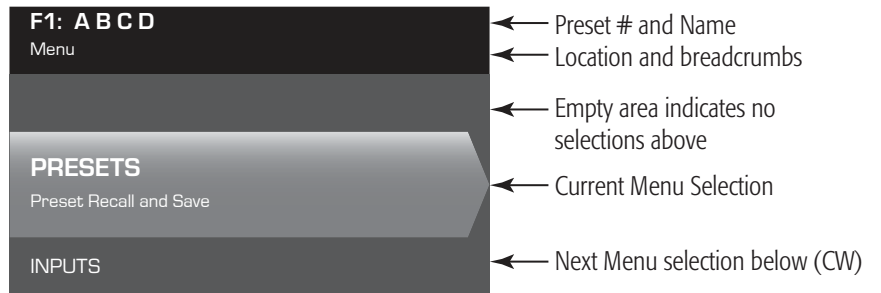

– Figure 22 –

Parameter Editing

Parameter editing screens allow you to select, edit, and confirm changes for various system parameters. Use the ENTER button to edit and confirm changes to parameters. Use the Master Control knob to select parameter, and make adjustments. Use the EXIT button to exit the edit mode without saving changes.

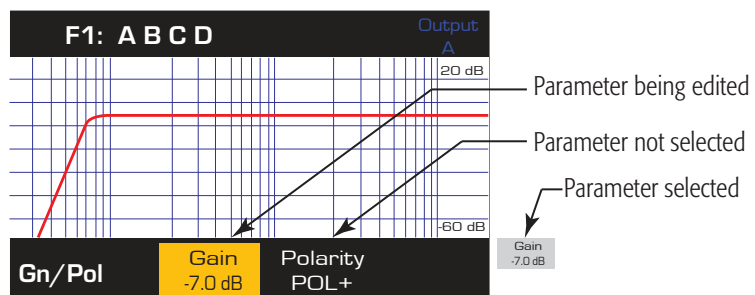

– Figure 23 –

About Presets

The CXD amplifiers are preset driven. An understanding of how presets work is essential to get the most out of the amplifiers. A Preset, in the context of the CXD amplifiers, is a combination of amplifier configuration (inputs and outputs), DSP, and loudspeaker assignments. When a preset is recalled it can change the output routing and any of the DSP settings.

The CXD amplifiers come with 20 unchangeable factory presets, and 50 user-defined presets. The factory presets are designed to be starting points for creating the presets you need for your particular installation. Factory presets F1: thru F9: have no DSP or loudspeaker assignments, only output configurations. Factory presets F10: thru F20: include basic settings along with the output configurations.

User-defined Presets

Presets U1 through U50 are all configured from the factory the same as factory preset F1. Anytime you save a preset, it overwrites one of the User-defined Presets. There are three ways of creating user-defined presets.

- You can recall a user-defined preset with the output configuration you want, then modify the DSP parameters and SAVE it by overwriting the one you recalled, or you can SAVE AS (overwrite) another user-defined preset.
- You can recall a factory preset, modify the parameters, then SAVE AS one of the user-defined presets. The SAVE procedure is not available for factory presets.
- You can use the Preset Wizard to set the output configuration, power output, and other parameters, then SAVE AS (overwrite) a user-defined preset.

Preset Wizard

The Preset Wizard simplifies the preset creation process, and allows you to create a preset from the ground up. The Preset Wizard provides a mechanism for you to select the desired power and load. Based on these selections, the best amplifier configuration is selected and you are then allowed to select and assign loudspeakers to each output.



NOTE: The power levels shown in this procedure are taken from the CXD4.3 unless indicated otherwise. CXD4.2 will show less power and CXD4.5 will show greater power. For complete details refer to the "Specifications" on page 31.

HOME > PRESETS > PRESET WIZARD (ENTER)

Step 1 – About the Preset Wizard

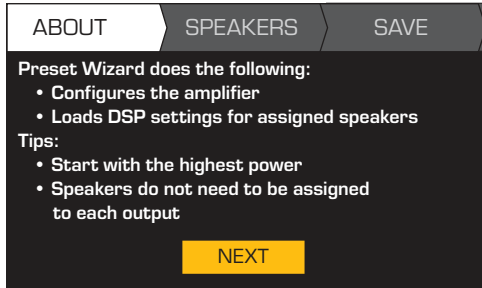

Preset Wizard does the following:

- Configures the amplifier
- Loads DSP settings for assigned speakers

Tips:

- Start with the highest power
- Speakers do not need to be assigned to each output

To Continue, press

HOME > PRESETS > PRESET WIZARD > ENTER (ENTER)

Step 2 – Adjust Impedance and Power

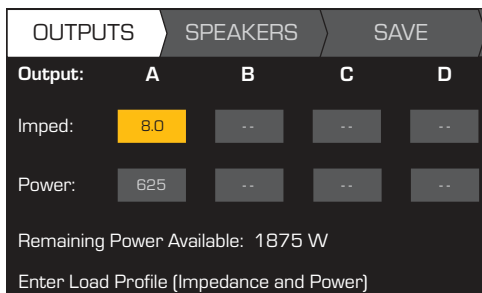

Adjust Impedance based on the total loudspeaker load connected to the channel.

← Default = 8 Ω

← Default = min. for amp

Impedance and Power are dynamically linked for adjustments.

Scroll to select (Impedance or Power)

To edit, press

Turn to adjust parameter

To confirm, press

Repeat for remaining output channels

Possible Output Mode Combinations using the Preset Wizard

	A	B	C	D	AB	C	D	AB	CD	A+B	C	D	A+B	C+D	ABC	D	AB + CD	ABCD
---	---	---	---	---	---	---	---	---	---	---	---	---	---	---	---	---	---	---
*	25%	25%	25%	25%	50%	25%	25%	50%	50%	50%	25%	25%	50%	50%	75%	25%	100%	100%

Modes: A B = Separate Channels / A+B = Bridge Mode / AB = Parallel Mode

* Percentages are used to represent the power for different amplifier models.

– Figure 24 –

Step 3 – Select Output Channel for Speaker Assignment

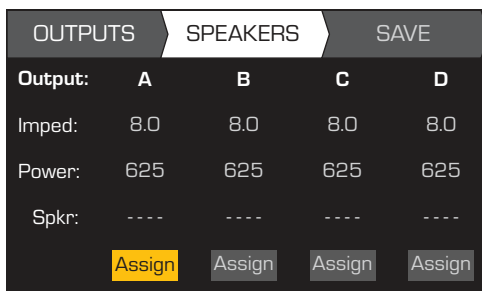

When you are finished setting the Impedance and Power for each output, continue to scroll to access the SPEAKERS tab.

Loudspeaker assignment is optional, you can assign a loudspeaker to one or more channels, or none at all.

Scroll to select the Output channel.

To Assign a loudspeaker, press

Continue to the next Step.

Step 4 – Select Speaker Type for Channel

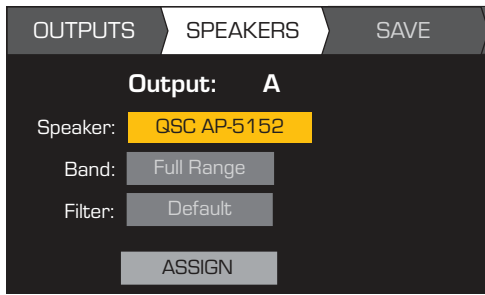

Band and Filter selections are based on the Speaker you select. You must select a loudspeaker before selecting Band and Filter.

When you have finished assigning loudspeakers, continue to scroll to access the SAVE tab.

- To edit Speaker, press
- Scroll to select a Speaker model
- To confirm, press
- Scroll to select (Band, Filter)
- To edit, press
- Turn to adjust parameter
- To confirm, press
- Scroll to select ASSIGN
- To assign the speaker to the output channel, press

Step 5 – Select User Preset Number

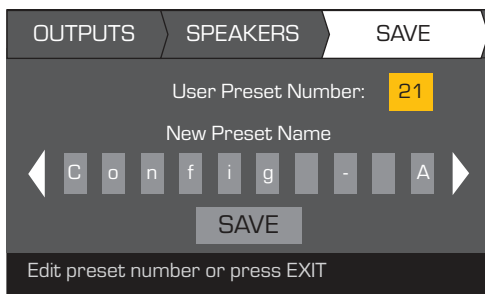

- Scroll to the Save screen
- To edit User Preset number, press
- Turn to adjust parameter
- To confirm, press
- Scroll to the New Preset Name

Step 6 – Assign New User Preset Name



Indicates editing

Indicates "Speaker Preset Name" is selected

Up to 21 characters
A - Z / a - z / 0 - 9 /
_ / - / space

- To add Speaker Profile Name, press
- Scroll to desired letter position press
- Turn to select desired character press
- When finished with lettering, press twice
- When finished, scroll to SAVE press
- To RECALL Preset, press
- To not RECALL Preset, press

Modify Presets

To modify a preset, recall the preset with the desired output configuration, modify the Input parameters, Output parameters, then save the preset. In addition, you can save the preset as you are going thru the creation process.

Recall a Preset

A Preset includes the output configuration, input parameters, and loudspeaker profiles (DSP, load, and assignments). There are 20 factory presets that can be recalled, but not overwritten, and 50 user-defined presets that can be recalled and overwritten.

- Factory presets F1: Config thru F9: Config contain output configurations only.
- Factory presets F10: thru F20: contain the output configurations and basic DSP for the configurations.
- There are 50 user presets that can be recalled and overwritten.

Recalling a Preset changes the configuration of the amplifier. You can recall factory or user-defined presets.

HOME > PRESETS > PRESET RECALL (ENTER)

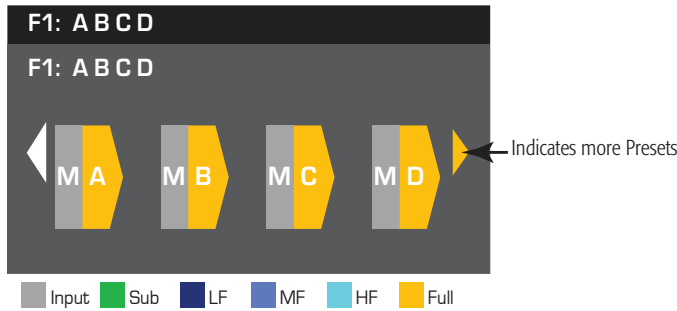

Step 1 – Select Preset

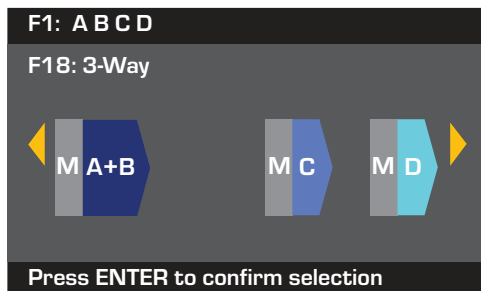

Scroll to desired Preset 
20 Factory, 50 User-defined

Step 2 – Confirm Selection



To select the Preset configuration, press 
To confirm the selection, press 

The message at the bottom changes to: "Recalling Preset now..."
You may hear relays clicking!

Set up the Inputs



NOTE: Changes made to input levels are in real time.

HOME > INPUTS > SENS (ENTER)

Step 1 – Select Input Sensitivity

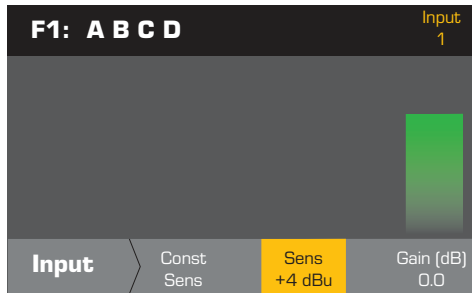

After confirming the Sensitivity setting, you can scroll to Gain and adjust it, before moving to the next Input.

Constant Sensitivity gives you maximum power out when the input device's output reaches the Sensitivity you set.
 +4 dBu = 70V into 8Ω
 +14 dBu = 100V into 8Ω

Scroll to select (+14 or +4 dBu) 

To confirm selection, press 

To move to the next input, press 

Repeat this procedure for remaining input channels

If sensitivity setting is +4 dBu, a 4 dBu signal from the input device results in 100V (CXD4.5) and 70V (CXD4.3) at the output of amplifier. So amplifier gain, at +4 dBu sensitivity, is 38.5 dB (CXD4.5) and 35.5 dB (CXD4.3). Input signal will clip 10 dB above sensitivity setting.

If sensitivity setting is +14 dBu, a 14 dBu signal from the input device results in 100V (CXD4.5) and 70V (CXD4.3) at the output of the amplifier. So amp gain at 14 dBu sensitivity is 28 dB (CXD4.5) and 25 dB (CXD4.3). Input signal will clip 10 dB above sensitivity setting.

HOME > INPUTS > INPUT GAIN (ENTER)

Step 2 – Set Input Gain



Scroll to select (-100 thru 20 dB) 

To confirm selection, press 

To move to the next input, press 

Repeat this procedure for remaining input channels

Set up the Outputs



NOTE: Changes made to outputs are in real time.

Mixer

The CXD amplifiers are equipped with an internal mixer that allows you to adjust the signals from each input to each of the four outputs. Figure 25 is a diagram of the Mixer for Output Channel A.

- The default setting for the Input Gain is 0.0 dB, and is set in the INPUTS section.
- Each output channel has four inputs, each controlled by a Mixer Gain.
- The Input Gain and Mixer Gain are cumulative. For example, if you set the Input Gain to +2.0 dB, and the Mixer Gain to -5.0 dB, the resulting output is -3.0 dB

As a default channel "1" is mixed to output A, 2 to B, 3 to C, and 4 to D, all other input channels are set to -100. Adjusting an Input Gain changes that channel's input to the mixers of all channels. Changing a Mixer Gain affects only that input for the selected output channel.

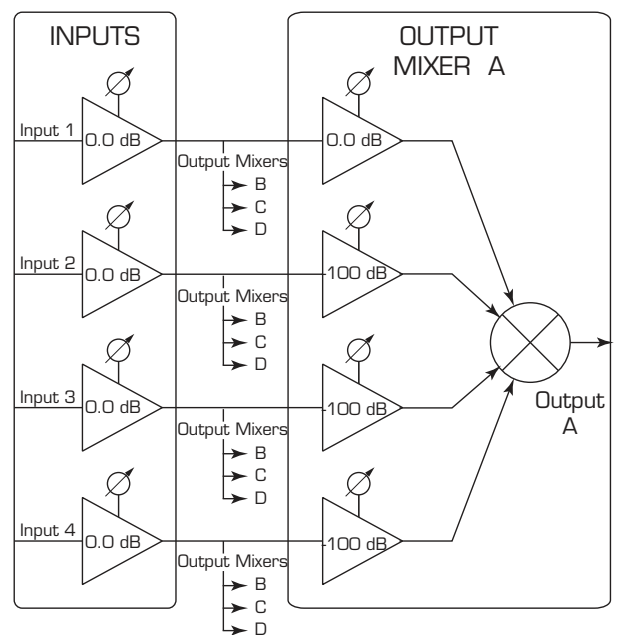

– Figure 25 –

HOME > OUTPUTS > MIXER (ENTER)

Step 1 – Set Mixer Gains

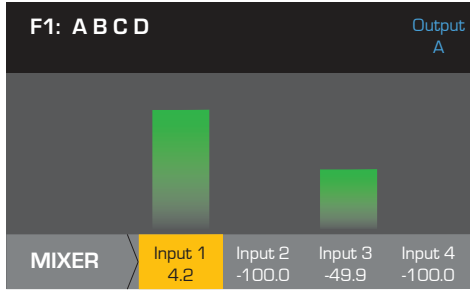

- Scroll to the Input you wish to adjust
- To edit, press
- Adjust the Gain for the selected input
- To confirm, press
- Repeat for the remaining inputs
- To move to the next Output, press
- When you are finished, press

HOME > OUTPUTS > MIXER (ENTER)

Step 1 – Test - Pink Noise and Tone Generator

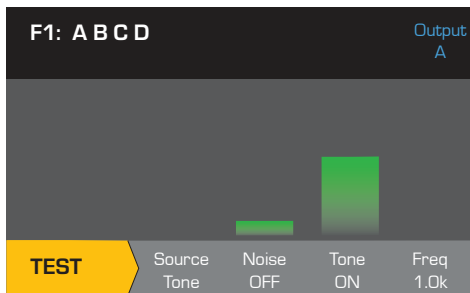

MIXER
PINK
20.0 Hz -20 kHz

Output Levels
Off (-80 dB) to -10 dB

- Scroll to TEST press
- On Source, press
- Select Tone or Noise press
- Scroll to Noise press
- Adjust Noise to desired level press
- Scroll to Tone press
- Adjust Tone to desired level press
- Scroll to Freq press
- Adjust to desired frequency press
- When you are finished, press

- You must be in the TEST mode to use Noise and Tone
- Noise and Tone cannot be used on the same channel at the same time.
- Use the Source to switch between Noise and Tone.
- Noise and Tone do not go through the Mixer.
- Noise and Tone Gain controls are independent of the Input and Output Gain controls.

Mode Select

HOME > OUTPUTS > MODE (ENTER)

Step 1 – Select the Output Mode

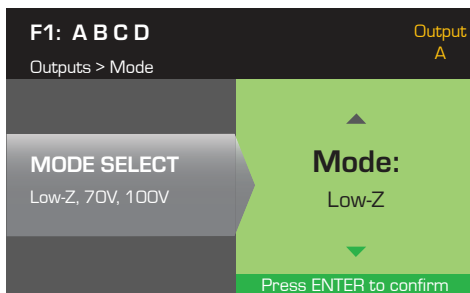

- Scroll to select Low-Z, 100V, or 70V
- To confirm, press

The CXD4.3 and CXD4.5 provide 70V and 100V direct drive for each output. The CXD4.2 offers 70V and 100V direct drive when two output channels are bridged.

Loudspeaker Processing

The Speaker Processing section allows you to make adjustments to the Crossover, EQ, Delay, Limiter, and QSC Array details for each output channel. In addition, you can load a pre-defined loudspeaker then make any adjustments needed, and save the changes as a user-defined loudspeaker. Depending on the loudspeaker selection, various parameters are not available for adjustment. When you make adjustments, you are making them in real time. If audio is passed while making changes, it is affected by the change.

The following instructions are not all in menu order, and all are optional. Repeat the following procedure for each output channel as necessary.

Load Speaker Profile

HOME > OUTPUTS > SPKR PROC > LOAD SPKR (ENTER)

A loudspeaker profile includes all the DSP and loudspeaker characteristics available in the SPKR PROC section. When you LOAD a loudspeaker, you are loading all of the DSP and characteristics of that loudspeaker. You can start by loading a loudspeaker and then make modifications and save your new profile, or you can build the profile without loading a loudspeaker, and then save it as a new profile. If you load a QSC loudspeaker, the amplifier is set for that specific loudspeaker and some parameters may be locked out because they are set to their optimal value by the Intrinsic Correction Calculator, and should not be adjusted. The CXD comes with a number of supported loudspeakers from other manufacturers. Refer to the list under "Supported Loudspeakers" on page 30. There may be additions to this list in the future that can be loaded with firmware updates.



NOTE: If you make changes to any of the loudspeaker processing parameters, and then LOAD a loudspeaker profile, all the changes you made are overwritten.

Step 1 – Load Speaker About

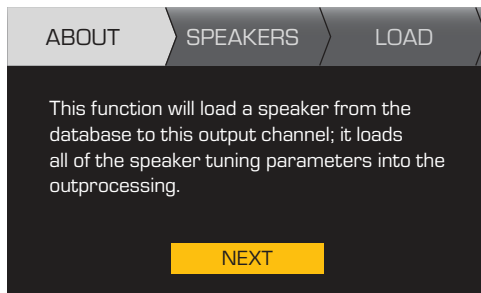

This function will load a speaker from the database to this output channel; it loads all of the speaker tuning parameters into the out-processing.

To continue, press 

Step 2 – Load an Existing Loudspeaker for the Selected Output

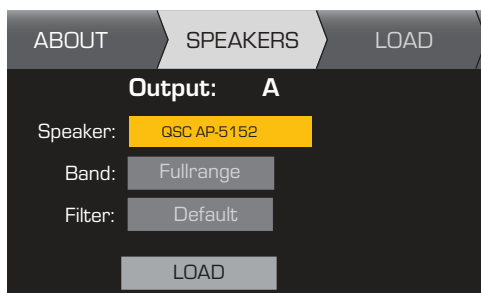

Band and Filter selections are displayed and constrained based on the loudspeaker.

To edit Speaker, press 

Scroll to select Speaker model 

To confirm, press 

Scroll to (Band, Filter) 

To adjust, press 

Adjust selected parameter 

To confirm, press 

Scroll to LOAD 

To Load the speaker profile to the selected output, press 

Crossover

HOME > OUTPUTS > SPKR PROC > CROSSOVER > HIGH-PASS (OR LOW-PASS) (ENTER)



NOTE: If you select a QSC Loudspeaker, you will see that the high-pass, or low-pass filters are LOCKED. QSC has given these loudspeakers specific voicings tailored for that loudspeaker that should not be changed. If there is any crossover adjustments applied in these voicings, you will be able to see the applied crossover on the graphs of the Crossover screens.

Step 1 – Set the Crossover High- and/or Low-pass filters

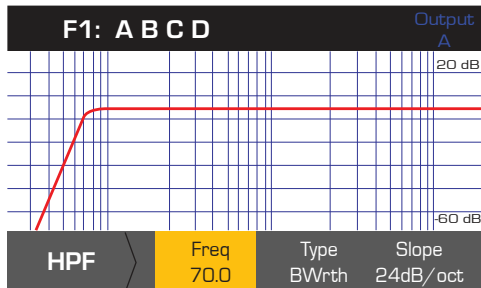





Freq: 20 - 20 kHz

Type:

- Butterworth
- Linkwitz-Riley
- Bessel-Thomson

Slope:
6dB to 48dB/oct depending
on Type

Scroll to select (Freq, Type, Slope) 
To edit, press 
Turn to adjust parameter 
To confirm, press 
To exit, press 



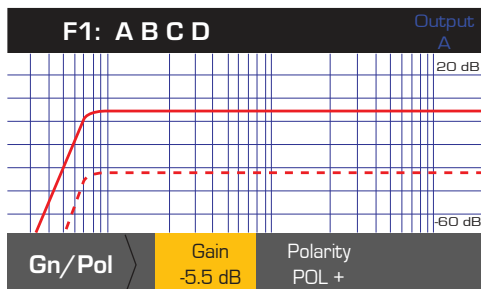

HOME > OUTPUTS > SPKR PROC > CROSSOVER > GAIN/POL > GAIN (ENTER)

Step 2 – Set the Crossover Gain and Polarity



+
Gain -100 to +20 dB
-

Polarity + or -

Scroll to select (Gain or Polarity) 
To edit, press 
Turn to adjust parameter 
To confirm, press 
To exit, press 

EQ

HOME > OUTPUTS > SPKR PROC > EQ > BAND 1, 2, 3, 4, OR 5 (ENTER)

The graph is a composite of all five bands. Each band has a full range of 20 Hz to 20 kHz.

Step 1 – Set the EQ

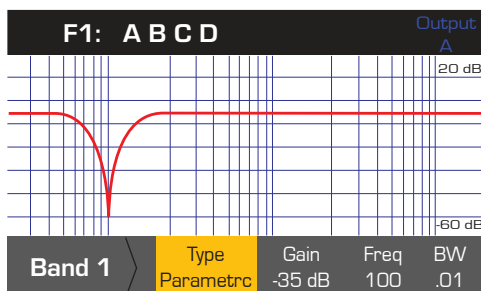





Type: Bypass, Parametric, Low Shelf, High Shelf (Default Bypass)

Gain: -40 to +20 dB (Default 0.00)

Freq: 20 to 20kHz (Band 1 Def 100 Hz)
(Band 2 Def 500 Hz)
(Band 3 Def 1 kHz)
(Band 4 Def 2.5 kHz)
(Band 5 Def 5 kHz)

BW: 0.01 to 3.00 Octave
(Default 1.00 Oct.)

Scroll to select (Type, Gain, Freq, BW) 
To edit, press 
Turn to adjust parameter 
To confirm, press 
To exit, press 

Delay

HOME > OUTPUTS > SPKR PROC > DELAY (ENTER)



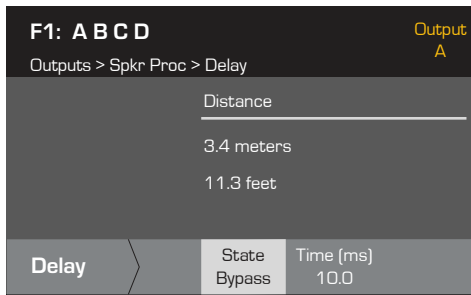

Distance measurements are based on the speed of sound being 340 meters/second, or 2.94 milliseconds/meter.

Step 1 – Set the Output Delay Time



Delay:
0.0 ms to
75.00 ms
0.021 to 1.0 ms increments

State:
Bypass or
On

- Scroll to (Delay Time or Bypass) 
- To edit, press 
- Turn to adjust parameter 
- To confirm, press 
- To exit, press 

Limiter



NOTE: If you select a QSC Loudspeaker, you will see that the limiter is LOCKED. QSC has given these loudspeakers specific limiter settings tailored for that loudspeaker that should not be changed. If there is a limiter applied in these voicings, you will be able to see the applied limiter on the graph.

HOME > OUTPUTS > SPKR PROC > LIMITER

Step 1 – Gain Reduction

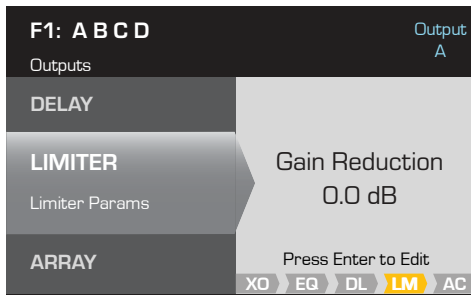



The Gain Reduction currently being applied to the selected Output channel.

To edit the Limiter settings, press 

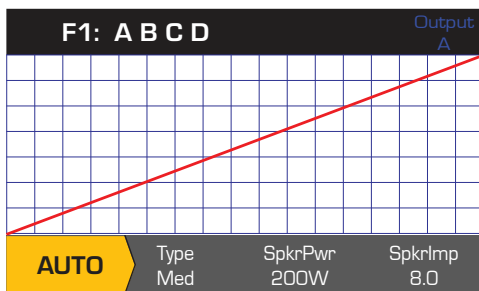
Step 2 – Set the Limiter Mode



To edit the Limiter mode, press 

Turn to select the mode for the Limiter 



To confirm setting, press 

Set AUTO Mode Parameters



NOTE: SpkrPwr maximum output depends on the amplifier and the output configuration you select. The maximum for separate channels is 1250 W, a single combined channel (ABCD or AB+CD) can be up to 5000 W depending on the amplifier.

HOME > OUTPUTS > SPKR PROC > LIMITER > AUTO

Step 1 – Set the AUTO Mode Parameters

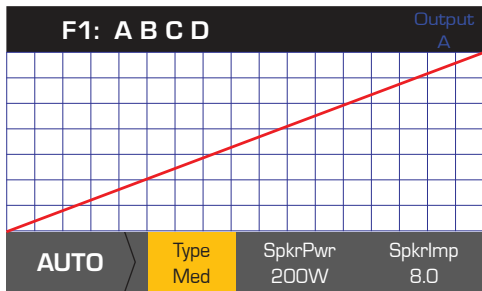

Type:
Aggressive
Medium
Mild
SpkrPwr:
10.0 W to 1250 KW
SpkrImpd:
2.0 Ω to 16.0 Ω

Scroll to select (Type, SpkrPwr, SpkrImp)
To edit, press
Turn to adjust parameter
To confirm, press
To exit, press

Type - the Auto Limiter Type is a protection level and its values are, Mild, Medium and Aggressive. This Type parameter, along with the Power Rating and Impedance drive an algorithm designed to maximize the performance of your loudspeakers. They set the RMS and Peak threshold values as well as their attack and release setting.

SpkrPwr - if a single speaker is being driven, the SpkrPwr should be the continuous power rating of that loudspeaker. If multiple speakers are being driven this value should be the combined power rating for the load.

SpkrImp - if a single speaker is being driven, the SpkrImp should be the nominal impedance of that loudspeaker. If multiple speakers are being driven this value should be the combined impedance for the load.

Set Advanced Mode Parameters



NOTE: If you select a QSC Loudspeaker, you will see that the limiter is LOCKED. QSC has given these loudspeakers specific limiter settings tailored for that loudspeaker that should not be changed. If there is a limiter applied in these voicings, you will be able to see the applied limiter on the graph. The limiter is also locked if the 70V or 100V mode is selected.

HOME > OUTPUTS > SPKR PROC > LIMITER > ADV

Step 2 – Set the ADV Mode Parameters

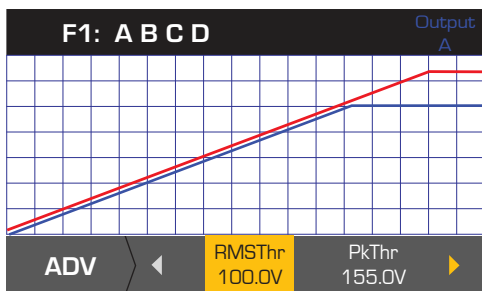

RMSThr: 3.0V to 100.0V
PkThr: 5.0V to 155.0V
PkAttk: 0.10 ms to 20.0 ms
PkRel: 1.00 ms to 1.0 s
RMSAttk: 0.05 s to 10.0 s
RMSRel: 1.0 s to 60.0 s

Scroll to select (RMSThr, PkThr, PkAttk, PkRel, RMSAttk, & RMSRel)
To edit, press
Turn to adjust parameter
To confirm, press
To exit, press

Thr = Threshold, Pk = Peak, Attk = Attack, Rel = Release

Array Correction

HOME > OUTPUTS > SPKR PROC > ARRAY (ENTER)



NOTE: You must have a QSC line array loaded in order to access the Array Correction parameters.

Step 1 – Set Splay Angle and Number of Boxes in the Array

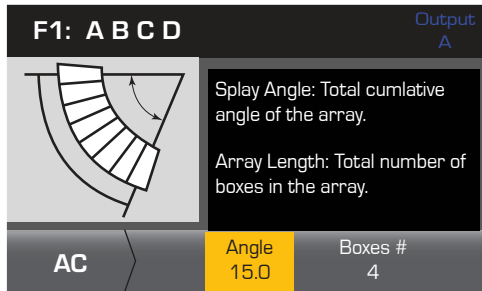

Angle:
0.0° to 90.0°

Boxes #:
0 to 24

Scroll to select (Angle or Boxes#)

To edit, press

Turn to adjust parameter

To confirm, press

To exit, press

Save a Loudspeaker

When you Save a speaker profile, you are saving all of the Output settings currently active for the channel. The new profile you save does not need to be Loaded, it is already active.

HOME > OUTPUTS > SPKR PROC > SAVE SPKR (ENTER)

Step 1 – Save Loudspeaker About

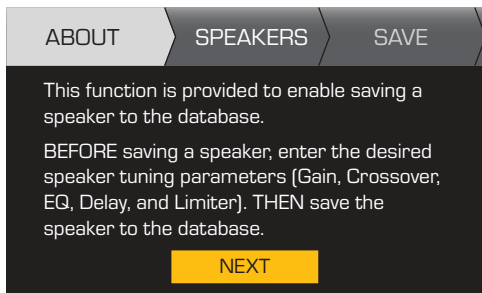

This function is provided to enable saving a speaker to the database.

BEFORE saving a speaker, enter the desired speaker tuning parameters (Gain, Crossover, EQ, Delay, and Limiter). THEN save the speaker to the database.

To continue, press

Step 2 – Save a Loudspeaker with Custom Load Profile

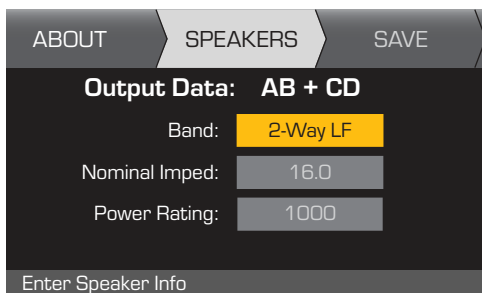

Nominal Impedance and Power Rating are the nominal settings for a single loudspeaker of this type.

Scroll to select (Band, Nominal Imped, Power Rating)

To edit, press

Turn to adjust parameter

To confirm, press

After confirming settings, Scroll to SAVE

Step 3 – Name the Loudspeaker Profile

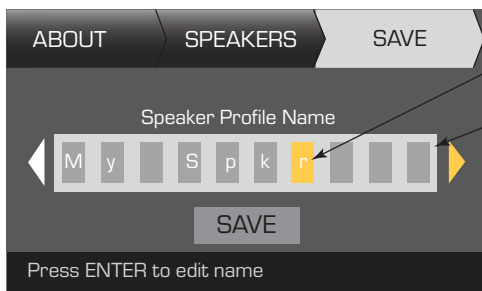

Indicates editing

Indicates "Speaker Profile Name" is selected.

Up to 21 characters
A - Z / a - z / 0 - 9 /
_ / - / space

To add Speaker Profile Name, press

Scroll to desired letter position press

Turn to select desired character press

When finished lettering, press twice

Scroll to SAVE press

Save a Preset

After modifying the Inputs and Outputs for all channels, save the current settings as one of the 50 user-defined presets (U1: thru U50:). Each of the user presets, by default, is the same as factory preset F1: A B C D, so when you save the preset you are "overwriting" the preset currently in that numbered position. If you started by recalling a factory preset, you must use the SAVE AS feature. If you started with a user-defined preset, you can overwrite the preset you started with using the SAVE feature, or use the SAVE AS feature to overwrite a different user preset.

SAVE AS

HOME > PRESETS > PRESET SAVE > PRESET SAVE AS > (ENTER)

Step 1 – Save a New Preset - Select and Edit Preset Number

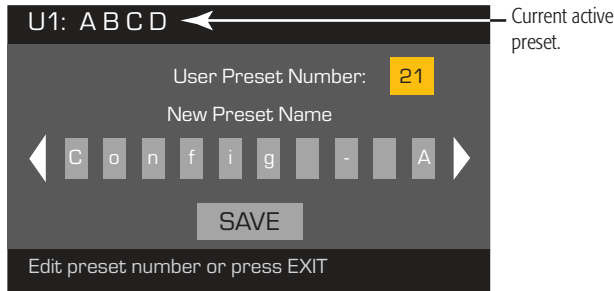

To edit User Preset number, press

Turn to select desired number (1 thru 50)

To confirm User Preset Number, press

Step 2 – Name the Preset

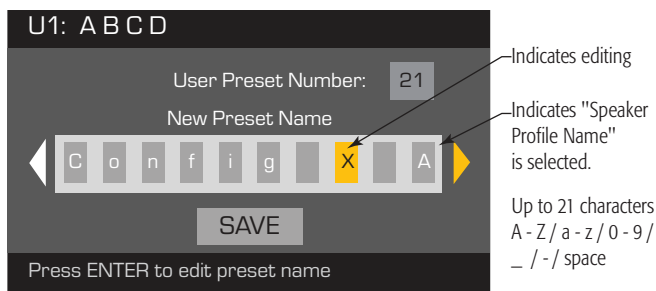

Scroll to New Preset Name press

Scroll to desired letter position press

Turn to select desired character press

Step 3 – Save Preset

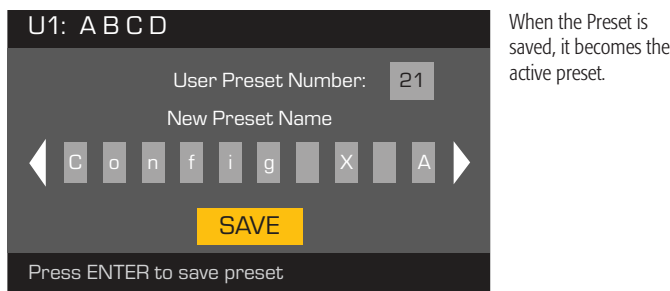

When you are finished naming, press

Scroll to SAVE

Press

To confirm SAVE, press

SAVE

Use this SAVE procedure when you are saving the preset by overwriting the currently active user preset. After you use the SAVE AS feature to save the preset you are working on, it then becomes the currently active preset, and you can use the SAVE feature to save as you work on the preset.

HOME > PRESETS > PRESET SAVE > SAVE (ENTER)

Step 1 – Overwrite Preset

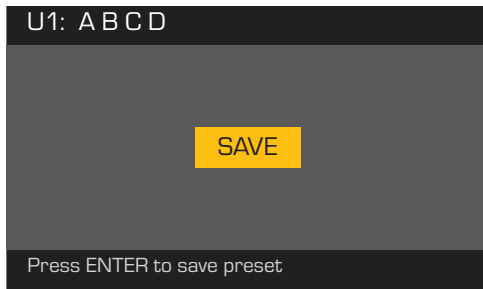

To save, press

To exit without saving, press

To confirm Save, press

Utilities

The Utilities section provides the following amplifier information and functionality:

Amplifier Health

HOME > UTILITIES > STATUS (ENTER)

Step 1 – Check the Amplifier's Health

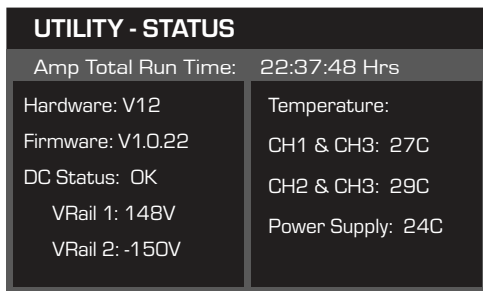

Amp Total Run Time:
HH:MM:SS

Hardware version

Firmware version
update thru Amplifier Navigator

DC Status:
VRail 1 = +147VDC +/- 5V typical
VRail 2 = -147VDC +/- 5V typical

Temperature (CXD 4.3 & 4.5)

Thermal Limiting starts at 69°C

Thermal Shutdown at 80°C

Name the Amplifier

HOME > UTILITIES > AMP ID (ENTER)

Step 1 – Name the Amplifier

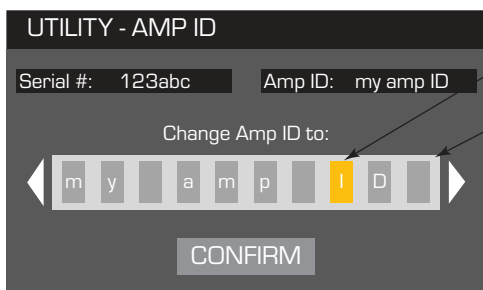

Indicates editing

Indicates "New Preset Name" is selected.

Up to 21 characters
A - Z / a - z / 0 - 9 /
_ / - / space

To edit "Change Amp ID to:" press

Scroll to desired letter position press

Turn to select desired character press

When you are finished, press

Scroll to CONFIRM press

Setup the Display

HOME > UTILITIES > DISPLAY (ENTER)

Step 1 – Display

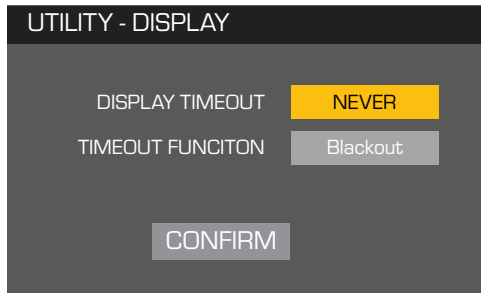

The HOME, ENTER, EXIT, GAIN, and the MASTER CONTROL exit Demo or Blackout mode. The power, MUTE and SEL buttons are still functional, in addition to exiting the Demo or Blackout mode.

- Scroll to desired DISPLAY TIMEOUT press
- Scroll to TIMEOUT FUNCTION press
- Turn to desired FUNCTION press
- Scroll to CONFIRM press

DISPLAY TIMEOUT
Never
10, 30 sec
1, 3, 5, 10, 15 min

TIMEOUT FUNCTION
Blackout
Demo

Password (Security)

HOME > UTILITIES > PASSWORD (ENTER)

Step 1 – Add or Change the Password



The default password for all amplifiers is QSC – all uppercase. The password can be up to 10 characters long, and contain, A-Z a-z 0-9 _ - space

- To enter "Current Password:", press
- With the first letter position selected, press
- Turn to select desired Character press
- When you complete the current password, the "New Password:" is automatically selected.
- Repeat the procedure for the "New Password:"
- Scroll to CONFIRM press

Lock the Amplifier

All controls are locked except the Mute buttons, front power button, rear power switch, Enter button and Master Control knob to unlock the amplifier.

HOME > UTILITIES > LOCKOUT (ENTER)

Step 1 – Enter Password to Lock or Unlock

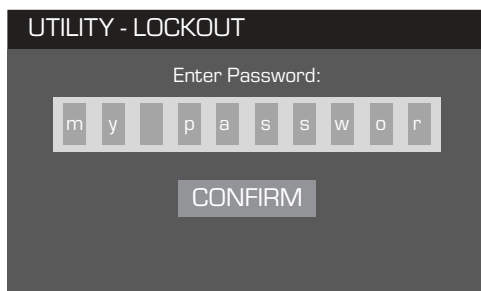

- With the first letter position selected, press
- Scroll to desired character press
- Continue this process to enter the remainder of the password.
- When you complete the password correctly, CONFIRM is automatically selected.
- To lock or unlock the amplifier, press

GPIO Connections

HOME > UTILITIES > GPI > ENTER



NOTE: If you Enable the GPI with nothing connected to the input pin, the GPI performs the selected GPI FUNCTION. In order to undo the result, you must manually reset whatever the GPI FUNCTION was, connect a switch to the input as described below, or you can reverse the GPI HIGH and GPI LOW.

Step 1 – Setup the GPI (Input) Feature

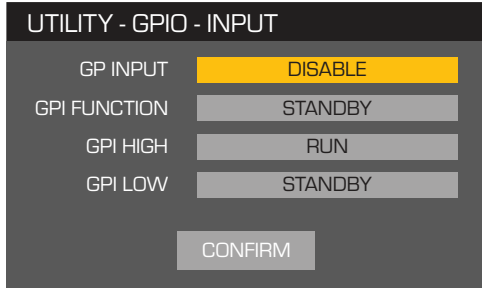

*For STANDBY and MUTE ALL, the GPI HIGH and GPI LOW results are linked opposites.

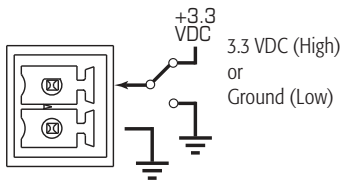

- STANDBY
 - GPI HIGH - Run or Standby
 - GPI LOW - Standby or Run
- MUTE ALL
 - GPI HIGH - Mute All or Unmute
 - GPI LOW - Unmute or Mute All
- RECALL PRESET
 - GPI HIGH - U1 through U50
 - GPI LOW - U1 through U50

- Select ENABLE or DISABLE press
- Scroll to GPI FUNCTION press
- Select desired function press
- Scroll to GPI HIGH press
- Select GPI HIGH result* press
- Scroll to GPI LOW press
- Select GPI LOW result* press
- When finished, scroll to CONFIRM press

HOME > UTILITIES > GPO > ENTER

Step 1 – Setup the GPO (Output) Feature

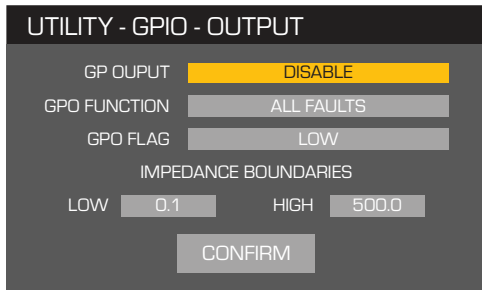

*Impedance settings are available only when GPO FUNCTION is ALL FAULTS or IMPEDANCE

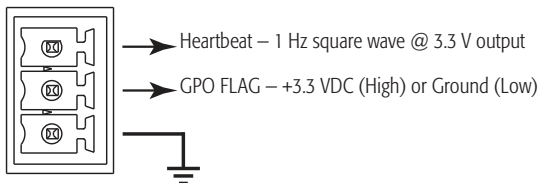

- GPO FUNCTION
 - ALL FAULTS
 - THERMAL LIMITING
 - IMPEDANCE
- GPO FLAG
 - LOW
 - HIGH
- IMPEDANCE BOUNDARIES*
 - 0.1 Ohms
 - 500.0 Ohms

- Select ENABLE or DISABLE press
- Scroll to GPO FUNCTION press
- Select desired function press
- Scroll to GPO FLAG press
- Select LOW or HIGH press
- Scroll to LOW* press
- Select LOW impedance value* press
- Scroll to HIGH* press
- Select HIGH impedance value* press
- When finished, scroll to Confirm press

Step 2 – Setup the GPO (Output) Feature

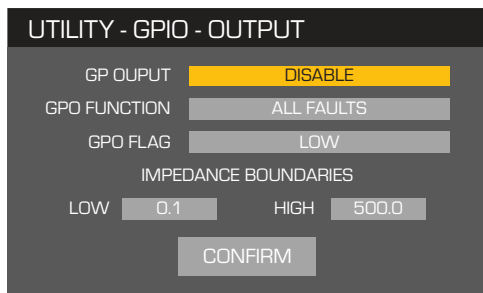

GPI FUNCTION
 ALL FAULTS
 THERMAL LIMITING
 IMPEDANCE

GPO FLAG
 LOW
 HIGH

IMPEDANCE BOUNDARIES*
 0.01 Ohms
 500.0 Ohms

- Select ENABLE or DISABLE press
- Scroll to GPO FUNCTION press
- Select desired function press
- Scroll to GPO FLAG press

Supported Loudspeakers

QSC

AC-C4T
AC-C6T
AD-C1200
AD-C42T
AD-C81Tw
AD-C820
AD-C821
AD-CI52ST
AD-CI52T
AD-S10T
AD-S112sw
AD-S12
AD-S28Tw
AD-S32T
AD-S4T
AD-S52
AD-S52T
AD-S6T
AD-S82
AD-S82H
AD-S8T
AP5102
AP5122
AP5122M-FOH
AP5122M-MON
AP5152
CSM12
CSM15
GP118
GP212
GP218
WL118
WL2082
WL2102
WL212
WL218
WL3082

Generic

FULLRANGE
SUB
LF
MF
HF

B52

LX1515V3
LX18V3
MX1515
MX18S

Cerwin-Vega (CV)

EL-36C
TS-42

Classic Pro

CSP12
CSP15

EV

ELX112
ELX115
ELX215
SX300E
TX2152
TX2181

JBL

JRX112M
JRX115
JRX118S
JRX125
MRX515
MRX518S
MRX525
MRX528S
PRX415M
PRX425
SRX712M
SRX715

JBL

SRX718S
SRX722
SRX725
SRX728S
SRX738
VRX932LA

Martin Audio

DD6 APRON
DD6 FLOOR
DD6 POLE
LE1200S
W8VDQ

Nexo

PS8
PS10-R2
PS15-R2

Peavey

PR10
PR12
PR15
PV115
PV118
PV12M
PV215
PVX12
PVX15
SP218
SP4

Yamaha

BR12
BR12M
BR15
C115V
S115V
S215V
SM15V
SW218V



NOTE: All third party presets are not approved by the manufacturer but were created using the manufacturer's published data.

Specifications

	CXD4.2			CXD4.3		CXD4.5	
Channel Configuration		Peak ¹	Continuous ²	Peak ¹	Continuous ²	Peak ¹	Continuous ²
70 V or 100 V Mode	70 V	N/A ³	N/A ³	500 W	500 W	1000 W	1000 W
	100 V	N/A ³	N/A ³	625 W	625 W	1250 W	1250 W
4 Independent Channels A, B, C, D	8 Ω	500 W	400 W	900 W	625 W	1200 W	1150 W
	4 Ω	700 W	400 W	1400 W	625 W	2000 W	1250 W
	2 Ω	625 W	325 W	1200 W	625 W	1600 W	625 W
2 Channels BTL Bridged A+B or C+D Doubles Voltage	8 Ω	1200 W ⁵	800 W ⁵	2400 W ⁵	1250 W ⁵	4000 W ⁵	2250 W ⁵
	4 Ω	1500 W ⁵	600 W ⁵	NR ⁴	NR ⁴	NR ⁴	NR ⁴
	2 Ω	NR ⁴	NR ⁴	NR ⁴	NR ⁴	NR ⁴	NR ⁴
2 Channels Parallel AB or CD Doubles Current	8 Ω	500 W	400 W	1300 W	1150 W	1250 W	1200 W
	4 Ω	950 W	800 W	2000 W ⁵	1250 W ⁵	2400 W ⁵	2250 W ⁵
	2 Ω	1200 W ⁵	800 W ⁵	2500 W ⁵	1250 W ⁵	4000 W ⁵	2100 W ⁵
1 Channel 3CH Parallel ABC Triples Current	8 Ω	500 W	400 W	1400 W	1150 W	1400 W	1150 W
	4 Ω	950 W	800 W	2400 W	2000 W	2500 W	2400 W
	2 Ω	1800 W	1200 W	3500 W	2500 W	4500 W	4100 W
1 Channel Bridged/Parallel AB+CD Doubles Current and Voltage	8 Ω	1600 W ⁵	1500 W ⁵	3500 W ⁵	2500 W ⁵	4500 W ⁵	4200 W ⁵
	4 Ω	2500 W ⁵	1600 W ⁵	5000 W ⁵	2500 W ⁵	7500 W ⁵	4200 W ⁵
	2 Ω	NR ⁴	NR ⁴	NR ⁴	NR ⁴	NR ⁴	NR ⁴
1 Channel 4CH Parallel ABCD Quadruples Current	8 Ω	500 W	400 W	1400 W	1150 W	1600 W	1150 W
	4 Ω	1000 W	800 W	3000 W	2500 W	3000 W	2300 W
	2 Ω	1700 W ⁵	1600 W ⁵	5000 W ⁵	2500 W ⁵	5300 W ⁵	4200 W ⁵
Typical Distortion							
	8 Ω	0.01 - 0.03%		0.01 - 0.03%		0.01 - 0.03%	
	4 Ω	0.03 - 0.06%		0.03 - 0.06%		0.03 - 0.06%	
Maximum Distortion 4 Ω - 8 Ω		1.0%		1.0%		1.0%	
Frequency response (8 Ω)							
	20 Hz - 15 kHz +/- 0.2 dB			20 Hz - 15 kHz +/- 0.2 dB		20 Hz - 15 kHz +/- 0.2 dB	
	20 Hz - 20 kHz +0.2 dB / -0.7 dB			20 Hz - 20 kHz +0.2 dB / -0.7 dB		20 Hz - 20 kHz +0.2 dB / -0.7 dB	
Noise							
	Unweighted Output Unmuted	-101 dB		-101 dB		-101 dB	
	Weighted Output Muted	-109 dB		-109 dB		-109 dB	
Gain (+4 dBu setting) Constant Sensitivity		33.5 dB		35.5 dB		38.5 dB	
Damping factor		>150		>150		>150	
Input impedance		>10 k, balanced or unbalanced		>10 k, balanced or unbalanced		>10 k, balanced or unbalanced	
Maximum input level							
	(+14 dBu setting)	4.24 V (+15 dBu)		4.24 V (+15 dBu)		4.24 V (+15 dBu)	
	(+4 dBu setting)	1.7 V (+7 dBu)		1.7 V (+7 dBu)		1.7 V (+7 dBu)	
Front Panel Controls and Indicators		Power • Channel MUTE Buttons • Channel SELECT Buttons • Channel Input Signal and CLIP LED Indicators • Channel Output and LIMIT LED Meters • HOME, ENTER, EXIT, GAIN Buttons • Control Knob					
Rear Panel Controls and Indicators		AC Power Disconnect Switch					
Input Connectors							
	Line	3-pin Euro-style					
	GPI	2-pin Euro-style 3.5 mm					
Output Connectors							
	Loudspeakers	8-pin Euro-style					
	GPIO	3-pin Euro-style 3.5 mm					
Amplifier and Load Protection		Short circuit, open circuit, thermal, RF protection. On/Off muting, DC fault shutdown, active inrush limiting					
AC Power Input		Universal power supply 100 - 132/200-240 VAC, 50 - 60 Hz		Universal Power Supply 100 - 240 VAC, 50 - 60 Hz			

Dimensions (HWD)	3.5" x 19" x 12" (89 x 482 x 305 mm)	3.5" x 19" x 16" (89 x 482 x 406 mm)	3.5" x 19" x 16" (89 x 482 mm x 406 mm)
Weight, Net / Shipping	18.5 lb (8.4 kg) / 22 lb (10.0 kg)	21.0 lb (9.5 kg) / 25 lb (11.3 kg)	22.0 lb (10.0 kg) / 26 lb (11.8 kg)

- 1 Peak Power – 20 ms 1 kHz sine burst, all channels driven
- 2 Continuous Power – EIA 1 kHz 1% THD, all channels driven
- 3 70V & 100V are available on CXD4.2 only when channels are bridged
- 4 NR – Not Recommended due to excessive current draw
- 5 **BOLD** indicates optimal configuration for the load and channel count

Heat Loss Charts

Heat losses are the thermal emissions from an amplifier while it is operating. It comes from dissipated waste power—i.e., real AC power in minus audio power out. Measurements are provided for various loads at idle, 1/8 of average full power, 1/3 of average full power, and full power, with all channels driven simultaneously. For typical usage, use the idle and 1/8 power figures. This data is measured from representative samples; due to production tolerances, actual heat emissions may vary slightly from one unit to another. Bridged mono into 8 ohms is equivalent to 4 ohms per channel; into 4 ohms is equivalent to 2 ohms per channel.

	BTU/hr	kcal/hr
Idle		
CXD 4.2	180	46
CXD 4.3	225	57
CXD 4.5	286	72

Load per Channel	8 Ω		4 Ω		2 Ω		25V-70V-100V	
	BTU/hr	kcal/hr	BTU/hr	kcal/hr	BTU/hr	kcal/hr	BTU/hr	kcal/hr
1/8th Power								
CXD 4.2	432	109	476	120	597	150	nr	nr
CXD 4.3	684	172	794	200	1040	262	nr	nr
CXD 4.5	811	204	1144	288	1124	283	nr	nr
1/3rd Power								
CXD 4.2	849	214	873	220	1215	306	nr	nr
CXD 4.3	983	248	1261	318	1869	471	nr	nr
CXD 4.5	881	222	1708	430	1737	438	nr	nr
Full Power								
CXD 4.2	1352	341	1478	372	2120	534	nr	nr
CXD 4.3	2498	629	2925	737	4198	1058	nr	nr
CXD 4.5	3116	785	5318	1340	4208	1060	nr	nr

Idle

Thermal loss at idle or with very low signal level.

1/8 Power

Thermal loss at 1/8 of full power is measured with pink noise. It approximates operating with music or voice with light clipping and represents the amplifier's typical "clean" maximum level, without audible clipping. Use these figures for typical maximum level operation.

1/3 Power

Thermal loss at 1/3 of full power is measured with pink noise. It approximates operating with music or voice with very heavy clipping and a very compressed dynamic range.

Full Power

Thermal loss at full power is measured with a 1 kHz sine wave. However, it does not represent any real-world operating condition.



NOTE: Specifications are subject to change without notice.



Mailing Address:

QSC, LLC

1675 MacArthur Boulevard

Costa Mesa, CA 92626-1468 USA

Telephone Numbers:

Main Number: (714) 754-6175

Sales & Marketing: (714) 957-7100 or toll free (USA only) (800) 854-4079

Customer Service: (714) 957-7150 or toll free (USA only) (800) 772-2834

Facsimile Numbers:

Sales & Marketing FAX: (714) 754-6174

Customer Service FAX: (714) 754-6173

World Wide Web:

www.qsc.com

E-mail:

info@qsc.com

service@qsc.com

© 2015 - 2016 QSC, LLC. All rights reserved. QSC and the QSC logo are registered trademarks of QSC, LLC in the U.S. Patent and Trademark office and other countries.

Cerwin-Vega® is a registered trademark of Cerwin-Vega, Electro-Voice is a registered trademark of Telex Communications, JBL is a trademark of HARMAN International Industries, Martin Audio is a registered trademark of Martin Audio Ltd., NEXO® is a registered trademark of NEXO SA, Peavey® is a registered trademark of Peavey Electronics Corporation, YAMAHA is a registered trademark of Yamaha Corporation.

All other trademarks are the property of their respective owners.

<http://patents.qsc.com>