

# MIPRO<sup>®</sup> MA-708

Portability

Simplicity

Flexibility

PORTABLE WIRELESS PA SYSTEM

User Guide



**MIPRO<sup>®</sup>**  
MICROPHONE PROFESSIONALS

**MIPRO Electronics Co., Ltd**

Headquarters : 814 Pei-Kang Road, Chiayi, 60096, Taiwan  
Tel : +886.5.238.0809 Fax : +886.5.238.0803  
www.mipro.com.tw mipro@mipro.com.tw



2 CE3 2 4 C

All rights reserved. Do not copy or forward without prior approvals MIPRO.  
Specifications and design subject to change without notice. MN 014/08

## **IMPORTANT SAFETY INSTRUCTIONS**

1. Read these instructions.
2. Keep these instructions.
3. Heed all warnings.
4. Follow all instructions.
5. Do not use this apparatus near water.
6. Clean only with a dry cloth.
7. Do not block any ventilation openings. Install in accordance with the manufacturer's instructions.
8. Do not install near any heat sources such as radiators, heat registers, stoves, or other apparatus (including amplifiers) that produce heat.
9. Do not defeat the safety purpose of the polarised or ground plug: A polarised plug has two blades with one wider than the other. The wide blade is provided for your safety. When the provided plug does not fit into your outlet, consult an electrician for replacement of the obsolete outlet.
10. Protect the power cord from being walked on or pinched particularly at plug, convenience receptacles, and the point where they exit from the apparatus.
11. Only use attachments/accessories specified by the manufacturer.
12. Use only with a cart, stand, tripod, bracket, or table specified by the manufacturer, or sold with the apparatus. When a cart is used, use caution when moving the cart/apparatus combination to avoid injury from tip-over.
13. Unplug this apparatus during lightning storms or when unused for long periods of time.
14. Refer all servicing to qualified service personnel. Servicing is required when the apparatus has been damaged in any way, such as power-supply cord or plug is damaged, liquid has been spilled or objects have fallen into the apparatus, the apparatus has been exposed to rain or moisture, does not operate normally, or has been dropped.
15. To reduce the risk of fire or electric shock, do not expose this apparatus to rain or moisture.
16. Apparatus should not be exposed to dripping or splashing and no objects filled with liquids, should be placed on the apparatus.
17. Use only with the battery which specified by manufacturer.
18. The power supply cord set is to be the mains disconnected device.
19. Where the MAINS plug or an appliance coupler is used as the disconnect device, the disconnect device shall remain readily operable.
20. Maximum operating temperature range is 50°C (122°F).  
Note: Battery characteristics may limit this range.



## **WARNING**

1. **FOR OUTDOOR USE:**  
To reduce the risk of fire or electric shock, do not expose this apparatus to rain or moisture.
2. **UNDER WET LOCATION:**  
Apparatus should not be exposed to dripping or splashing and no objects filled with liquids, such as vases should be placed on the apparatus.
3. **SERVICE INSTRUCTIONS:**  
CAUTION - These servicing instructions are for use by qualified service personnel only. To reduce the risk of electric shock, do not perform any servicing other than that contained in the operating instructions unless you are qualified to do so.



 This symbol indicates that dangerous voltage constituting a risk of electric shock is present within this unit.

 This symbol indicates that there are important operating and maintenance instructions in the literature accompanying this unit.

## **FC & IC - ID**

THIS DEVICE COMPLIES WITH PART15 OF THE FCC RULES AND RSS-123 ISSUE2 OF CANADA. OPERATION IS SUBJECT TO THE FOLLOWING TWO CONDITIONS:

- (1) This device may not cause interference.
- (2) This device must accept any interference, including interference that may cause undesired operation of the device. This equipment complies with FCC RF radiation exposure limits set forth for an uncontrolled environment.

"This product can only be used at the area that the altitude is lower than 2000m for safety purpose."

"This product can be used in non-tropical locations only for safety purpose."

## **Disposal**



2005-08-13

Dispose of any unusable devices or batteries responsibly and in accordance with any applicable regulations.

Disposing of used batteries with domestic waste is to be avoided!

Batteries/NiCad cells often contain heavy metals such as cadmium(Cd), mercury(Hg) and lead(Pb) that makes them unsuitable for disposal with domestic waste. You may return spent batteries/accumulators free of charge to recycling centres or anywhere else batteries/accumulators are sold.

By doing so, you contribute to the conservation of our environment!

**CONTENTS**

CONTROLS AND INDICATORS ----- 02

CONTROL PANEL ----- 04

CONNECTION FOR EXTERNAL AUDIO SOURCES ----- 05

OPERATION OF TRANSMITTERS STORAGE ----- 06

REPLACING BATTERIES ----- 07

POWER USAGE INSTRUCTION ----- 09

SELECTION AND INSTALLATION OF WIRELESS RECEIVER MODULES ----- 10

UHF WIRELESS DIVERSITY RECEIVER MODULE ----- 11

SET-UP RECEIVER AND TRANSMITTER FREQUENCIES ----- 12

WIRELESS INTERLINKING TRANSMITTER AND RECEIVER MODULES ----- 13

MTM-90/MTM-92 COMPARTMENT FOR BODYPACK TRANSMITTER ----- 14

INSTALLATION OF MIPRO CD/MP3 PLAYER ----- 15

HELPFUL OPERATING TIPS ----- 15

TROUBLESHOOTING-PORTABLE PUBLIC ADDRESS ----- 16

TROUBLESHOOTING-WIRELESS MICROPHONE SYSTEMS ----- 17

FAQ - PORTABLE PA ----- 18

FAQ - RECHARGEABLE BATTERY ----- 18

RECHARGEABLE BATTERY GUIDE ----- 19

OPTIONAL MA-708 ACCESSORIES ----- 20

MIPRO WIRELESS MICROPHONE SYSTEMS ----- 21

MA-708 delivers unparalleled audio performance and innovative features. Improved "limiter " circuitry reduces distortion and increases intelligibility for guaranteed powerful and clear sound. Designed for medium-sized audiences. Rugged and compact enclosure design, is perfect for medium to large venues such as schools, places of worship, corporate multimedia presentations, trade shows, Auctions, funeral services, weddings, shopping center presentations, special events, lectures, political campaigns and musical ensembles.

**ACCESSORIES**

**The following accessories are included:**

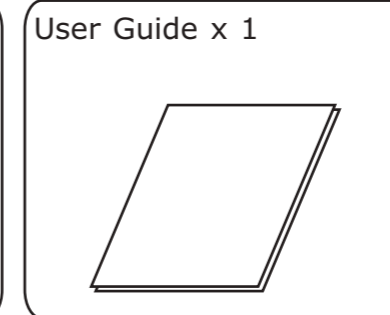
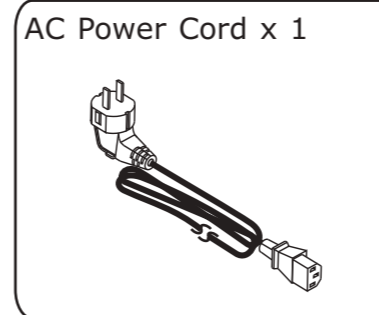

**The following accessories are not included:**



**CONTROLS AND INDICATORS**

**Front Panel**

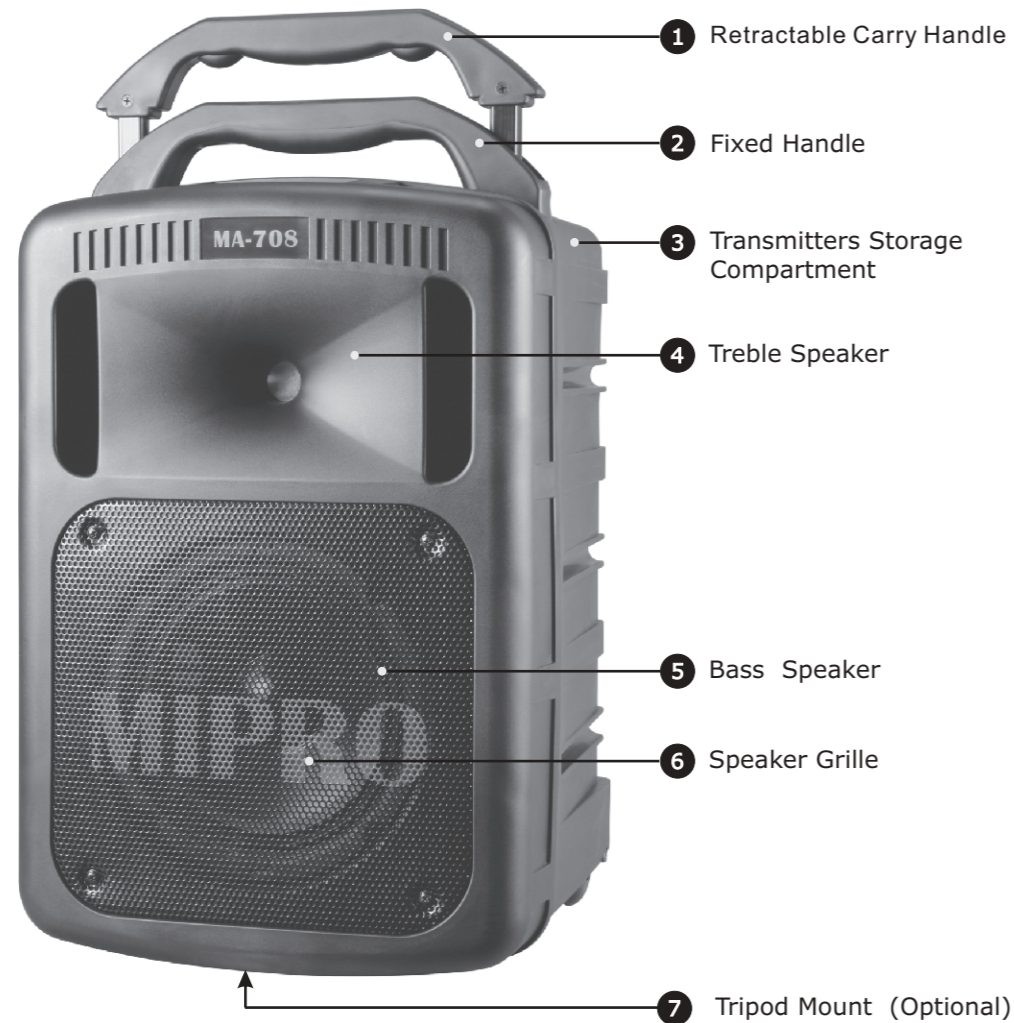

- ❶ **Retractable Carry Handle:** Pull the handle upward from the space on the rear center to retrieve retractable handle. Push downward to store the retractable handle.
- ❷ **Fixed Handle:** For balanced, easy hand carrying.
- ❸ **Transmitters Storage Compartment:** A handy storage compartment for 2 wireless handheld or bodypack transmitters.
- ❹ **Treble Speaker:** 1" Titanium Compression Driver.
- ❺ **Bass Speaker:** 8" Neodymium Cone Driver.
- ❻ **Speaker Grille:** To protect the internal speaker.
- ❼ **Tripod Mount (Optional):** There is a tripod mating socket mounted in the base of the MA-708 to accommodate a 35mm tripod stand.

**Rear Panel**

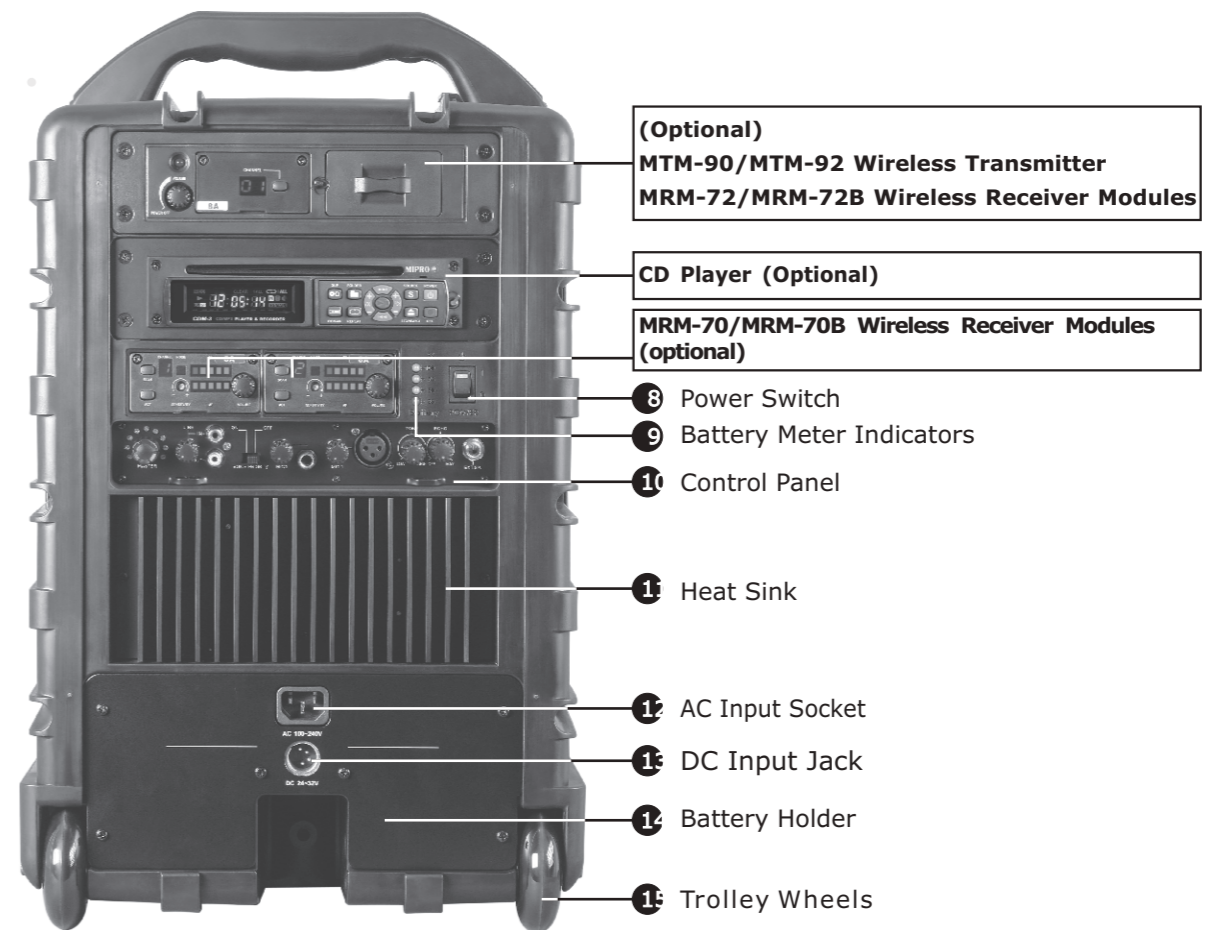

- ❽ **Power Switch:** Turns power on/off. The indicator glows when you turn the power on.
- ❾ **Battery Meter Indicators:** 25%, 50%, 75%, 100% capacity. Charge battery immediately at 25% (red indicator denotes low battery status) by plug the system into an AC outlet. Regardless of length of operation, it is recommended that batteries be fully charged as soon as possible after each use to preserve battery life.
- ❿ **Control Panel**
- ⓫ **Heat Sink:** Built in heat sink for amplifier. Keep the unit well ventilated when in use and please do not touch the heat sink when in operation.
- ⓬ **AC Power Input Socket:** Input socket for AC Power (100~240V). (Various outlets fitting the standards of various countries are available for this unit)
- ⓭ **DC Input Jack:** Requires external DC 24~36 volts.
- ⓮ **Battery Holder:** Battery compartment holder is to protect the rechargeable batteries. To install the batteries, please follow wiring diagram carefully and make sure each terminal is connected to it's correct polarity. Please make sure that the batteries are fully charged at all time.
- ⓯ **Trolley Wheels:** Heavy duty and a truly user friendly feature.

**CONTROL PANEL**

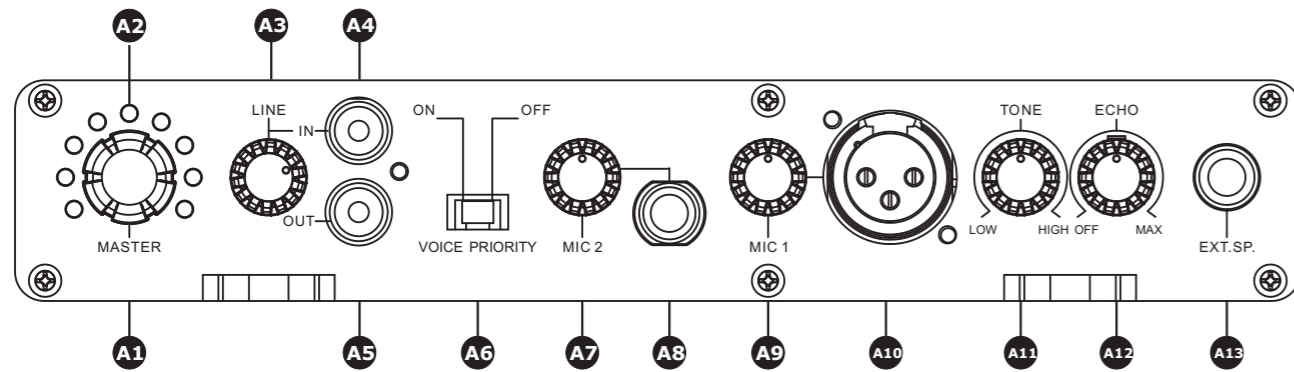

- A1 Digital Master Volume Control:** Volume loudness can be remotely controlled and wirelessly adjusted by MIPRO ACT-30Hr/ACT-32HR Handheld Transmitter Microphone.
- A2 Volume Indicators:** Each indicator is illuminated based on the desired volume adjustment.
- A3 LINE In Volume Control:** Controls the volume of the Line Socket.
- A4 Line In Socket:** Allows you to use an external device with unbalanced audio output signal as an input to the MA-708.
- A5 Line Out Socket:** Line level output. Allows you to use the MA-708 as a program input source for some other audio device.
- A6 Voice Priority Switch:** Voice over music priority function. (factory preset: Off)
- A7 Mic 2 Volume Control:** Control the volume of the Mic 2 wired microphone.
- A8 Wired Microphone Input Socket [6.3mm (1/4")] Unbalanced :** Allows you to use an unbalanced, wired microphone as an input source.
- A9 Mic 1 Volume Control :** Control the volume of the Mic 1 wired microphone.
- A10 Wired Microphone Input Socket (XLR Balanced) :** Allows you to use a wired microphone with a balanced XLR connector as an input source.
- A11 TONE Control:** Turn counterclockwise to increase bass or turn clockwise to increase treble. Positioned at 12 o'clock for a flat response.
- A12 ECHO Control :** Adjust for desired ECHO effects .
- A13 Extension Speaker Socket :** Connecting to a MIPRO MA-708EXP extension speaker (passive).

**CONNECTION FOR EXTERNAL AUDIO SOURCES**

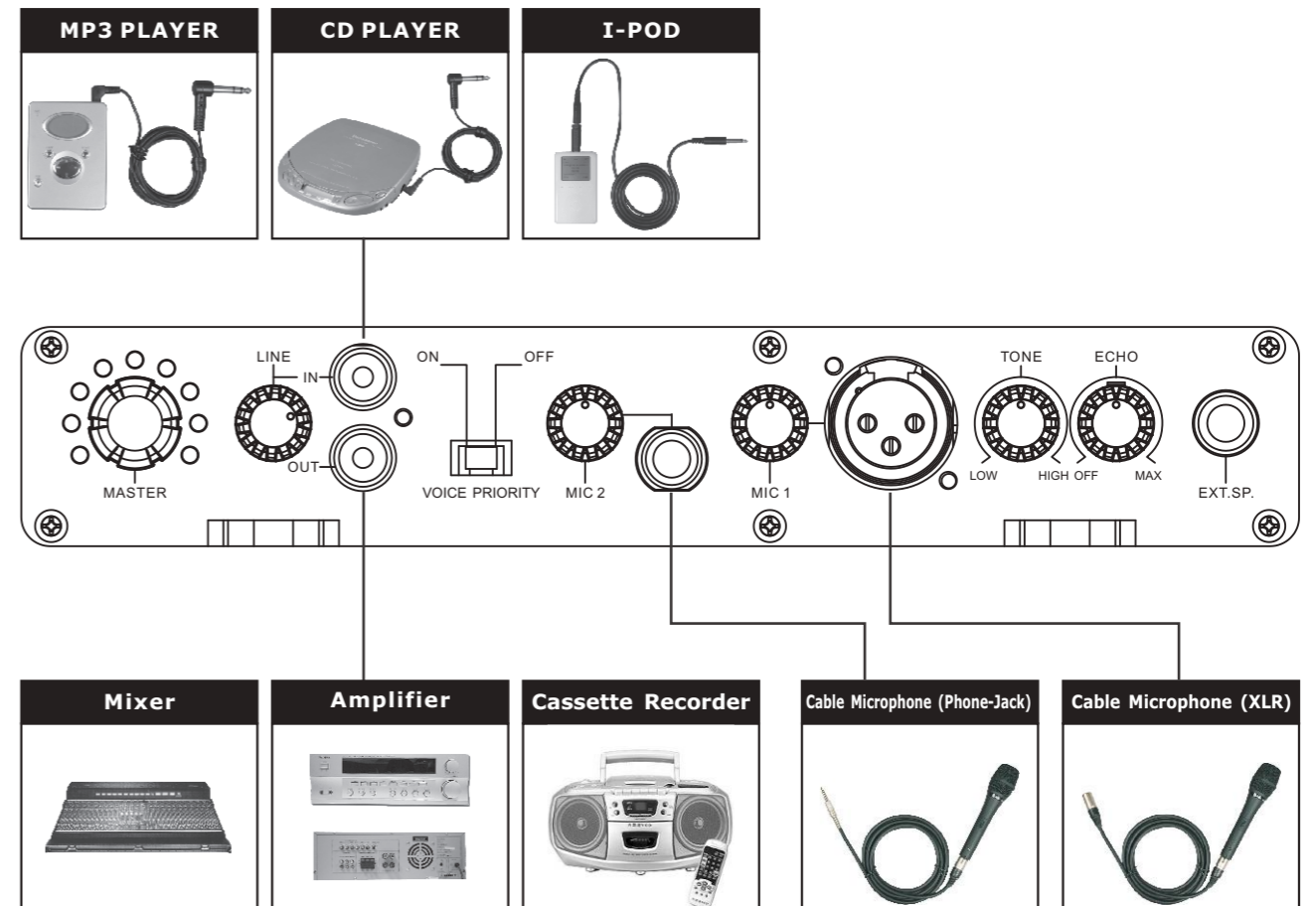

**OPERATION OF TRANSMITTERS STORAGE**

1. Two handheld transmitters, or two bodypack transmitters, or one handheld transmitter and one bodypack transmitter can be stored inside a unique compartment of MA-708.
2. Steps of storing transmitters.
  - A. Open the lid. (see figure: **A** & **D**)
  - B. Place the transmitters downward to position correctly. (see figure: **B** & **E**)
  - C. Return the lid to the closed position. (see figure: **C** & **F**)

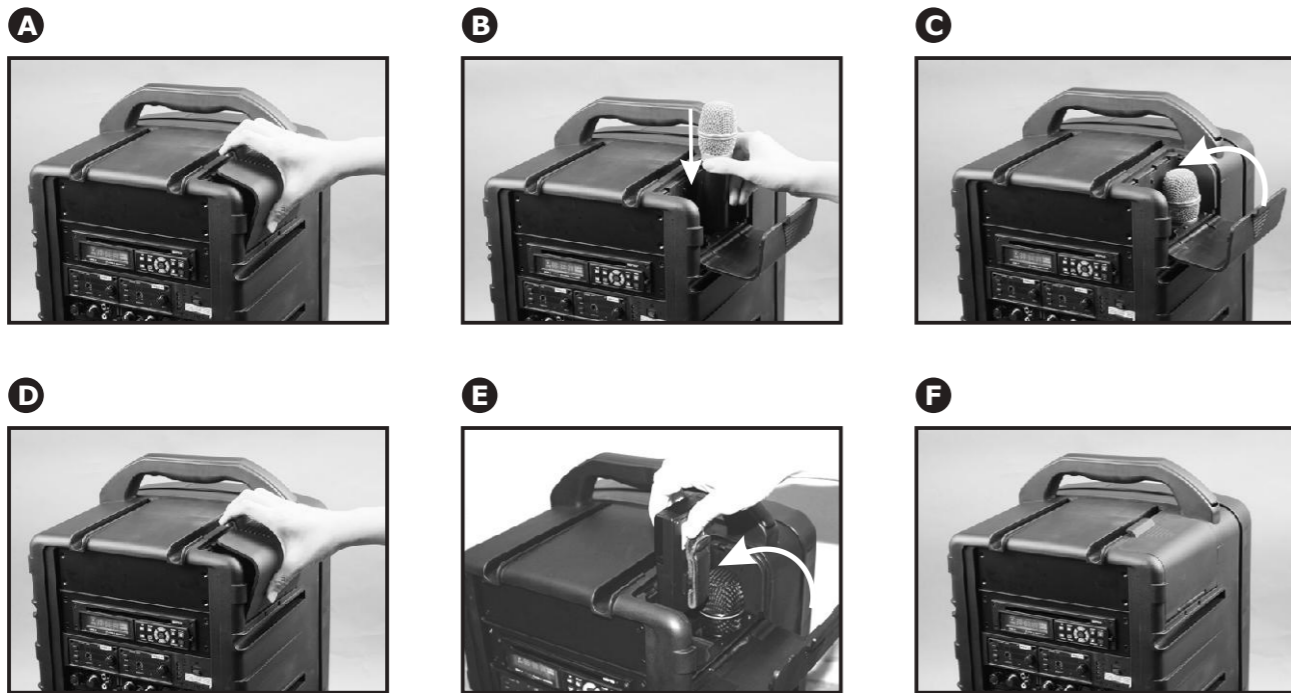

**REPLACING BATTERIES**

The batteries must be replaced every 2~3 years depending on usage over time. Ascertain the power switch is turned off and AC cord is unplugged.

- A. Using a Phillips-head screwdriver (not supplied) remove the screws to remove battery protection cover panel. (see figure 1-1)
- B. To remove batteries, gently slide the battery away from the battery housing compartment of MA-708. (see figure 1-2)
- C. Replace batteries "as above" and re-connect the wires to the new batteries in accordance to the wiring diagram below. (see figure 1-3)
- D. Replace the battery protection cover panel, tighten up the screws. (see figure 1-4)

(Figure 1-1)

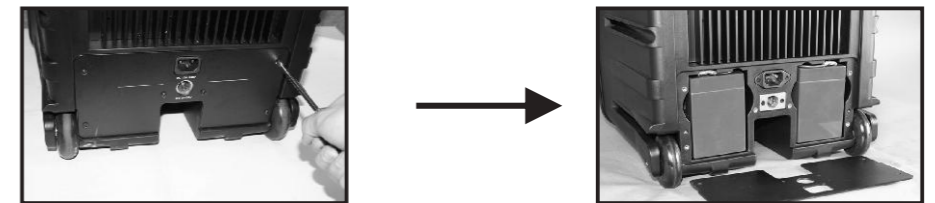

(Figure 1-2)

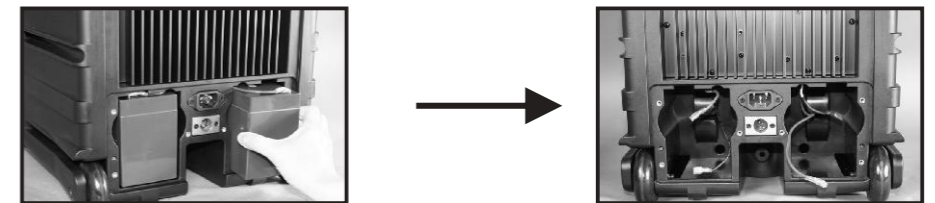

(Figure 1-3)

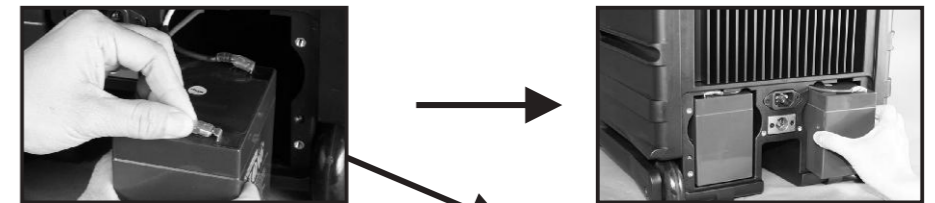

(Battery wiring diagram)

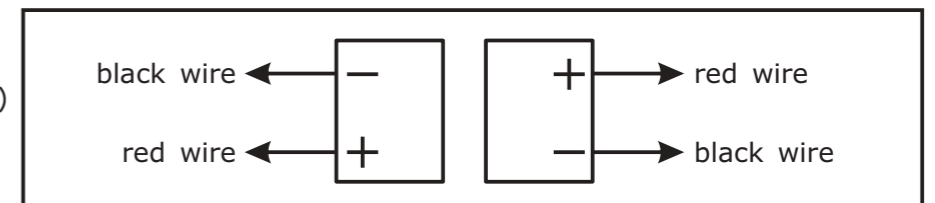

(Figure 1-4)

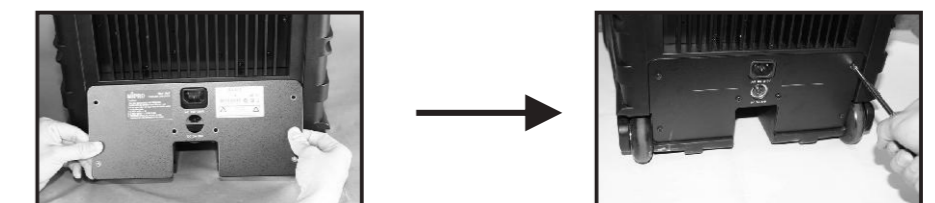

Please only use the following rechargeable internal battery (MIPRO MB-70 x 2 or MB-80 x 2) or an equivalent rechargeable battery of the same type, rating & specifications when it is required to be replaced.

<b>Manufacturer</b>	<b>Kung Long Batteries Industrial Co., Ltd.</b>
<b>Cat No</b>	<b>WP4.5-12</b>
<b>Rating</b>	<b>12 Vdc, 4.5 Ah</b>

 **CAUTION:**

- Always change both rechargeable batteries at the same time.
- Do not mix battery types and do not mix old and new batteries. Replace both batteries at the same time.
- Replace with the same type and rating rechargeable battery only.
- Rechargeable battery can be purchased from authorized MIPRO distributors & dealers.
- Danger of explosion if battery is incorrectly replaced.
- Do not try to heat, ignite, disassemble or throw batteries into a fire.

**POWER USAGE INSTRUCTION**

**General Summary**

- A built-in switching power supply allows for AC power inputs ranging from 100 ~ 240volt and an external 24~32volt DC power supply, if required.
- A built-in AC power supply powers the unit itself and provides recharging to the built-in lead-acid rechargeable batteries, too.

**How to use AC power input**

- After putting the power plug into the AC input socket of the device, the 4 battery meter indicators will glow immediately, no matter if the power switch is on or off. This means that the built-in switching power supply is functioning normally and the built-in rechargeable batteries are fully charged. If the battery meter indicators are blinking this means that the built-in switching power supply is working normally and the built-in rechargeable batteries are in an under charged condition. After a couple of minutes, the battery meter indicators will stop blinking and continue a glowing condition, indicating the batteries are now fully charged.
- AC power provides power to both the unit itself and to the built-in lead-acid rechargeable batteries.
- When using the AC power, you can remove or plug the power cord freely with no need to turn off the power switch first. If or when an unfortunate power cut happens during usage, the MA-708 will activate the DC power automatically to maintain continuous operation.

**How to use DC power input**

- Two built-in series connection lead-acid batteries with models WP 4.5-12 are used. When the batteries are fully charged, the unit can be operated continuously for approximately 7~8 hours in standby mode (CD player and two receivers are turned on); 6~7 hours for audio and 5~6 hours for music. (The above figures are references for brand new batteries only)
- The built-in rechargeable batteries can be recharged when the unit is plugged into an AC or DC power outlet.
- In the case of no AC power connection, if the power switch is not turned on, the battery meter indicators will not be shining. When the power switch is turned on, the red LED on it will be shining; meanwhile, if 2 to 4 battery meter indicators are shining, it means the battery power is enough for normal operation. The number of the shining indicators is in direct proportion of the battery power. If only 1 battery meter indicator is shining or the red LED on the power switch is sparking, it means the battery power is insufficient and immediate charge is necessary. If no battery meter indicators are shining after the power switch is turned on, it means the batteries are completely discharged or possibly faulty.
- Always store MA-708 system with the batteries fully charged if needing to store the system for more than 3 months. Leave the system plugged into an AC power outlet when not in use.
- The rechargeable batteries will not function properly if not recharged for an extended period of time. It is therefore, recommended to recharge after every use regardless of the usage time to preserve battery life.

 **AC power and DC power can not be used at the same time.**

A connector is included which allows users to make DC wiring. See diagram below for illustration:

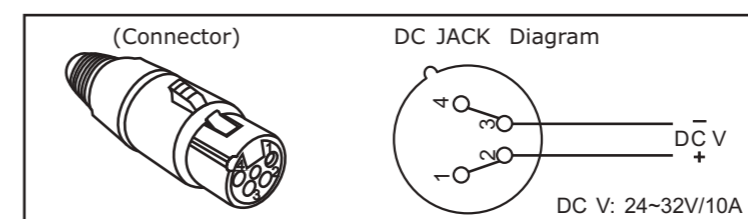

**SELECTION AND INSTALLATION OF WIRELESS RECEIVER MODULES**

1. Each MA-708 can install up to 4 wireless diversity receiver modules for extended and reliable reception: 2 MRM-70 (or MRM-70B) + 1 MRM-72 (or MRM-72B). A single MRM-72 (or MRM-72B) consists of 2 MRM-70 (or MRM-70B) side-by-side.
2. Installation or replacement of MRM-70 (or MRM-70B) or MRM-72 (or MRM-72B) wireless receiver modules:
  - Using a Phillips-head screwdriver (not supplied) remove the screws to remove receiver protection cover panel. (see figure: **A** & **B** )
  - Gently insert the receiver module into the slot. Make sure the back edge connector is aligned and firmly connected. (see figure: **C** & **D** )
  - Tighten up the screws. (see figure **E** )

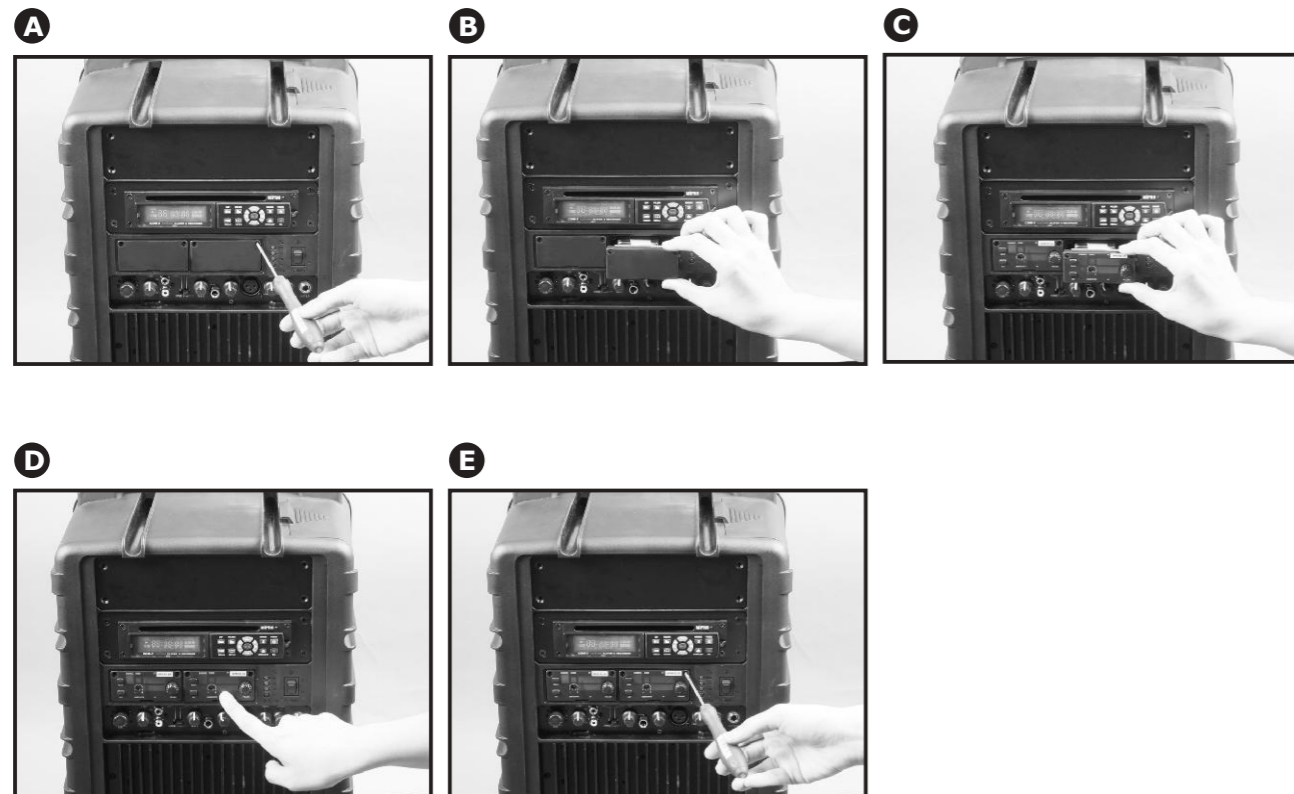

**MRM-70/MRM-70B:**

**UHF WIRELESS DIVERSITY RECEIVER MODULE (SINGLE)**

**MRM-72/MRM-72B:**

**UHF WIRELESS DIVERSITY RECEIVER MODULE (DUAL SIDE-BY-SIDE)**

MIPRO offers industry-leading diversity wireless receiver module. Up to 4 wireless receiver modules can be installed quickly and easily for wireless microphone operation. Each receiver module has 16 preset UHF frequencies. Simply press the "scan" button once to quickly auto scan for a clear, interference-free receiver frequency. A built-in "noise" interference indicator (when lit) detects the presence of interference. Press scan button again to auto scan for another clear, interference-free frequency if lit.

**OPERATING THE MRM-70/MRM-70B or MRM-72/MRM-72B UHF DIVERSITY RECEIVER MODULE**

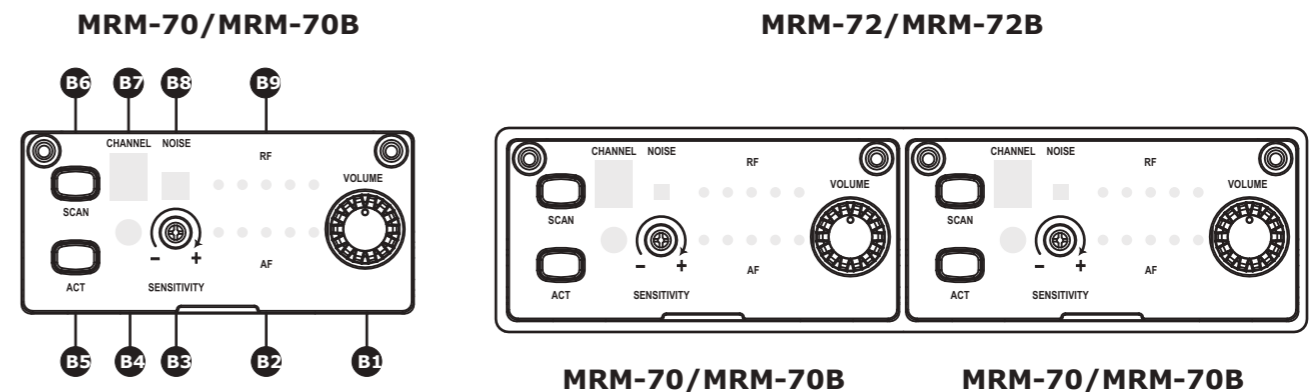

- B1 Receiver Power Switch/Volume Control:** Turns on/off of receiver. After power on, AF LED will flash. Turn knob clockwise to turn up volume.
- B2 Audio Signal Meter:** Indicate the audio signal level.
- B3 Sensitivity Adjuster:** Higher sensitivity (+) to increase receiving distance. Lower sensitivity (-) to minimize noise interference.  
\*Note: lower sensitivity level also reduces operating distance.
- B4 ACT Infrared (IR) Port:** Transmits IR signal to transmitter to synchronize frequencies.
- B5 ACT Sync Button:** Press to synchronize the receiver and transmitter frequencies.
- B6 SCAN Button:** Press for an interference-free channel.
- B7 LED Screen:** Displays current receiver channel.
- B8 Noise Indicator:** When lit, it denotes the presence of interference.
- B9 RF Signal Meter:** Indicate the RF signal strength received when transmitter is turned on.



**SET-UP RECEIVER AND TRANSMITTER FREQUENCIES**

**AUTOMATIC "RECEIVER" FREQUENCY SELECTION**

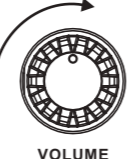
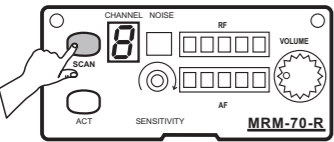
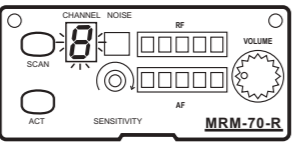
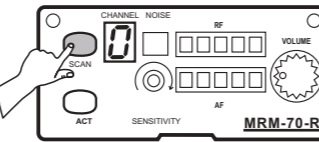
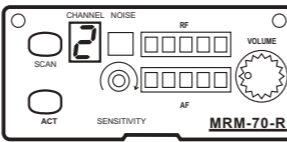
1. POWER "ON" the portable PA 
2. POWER on receiver by turning "VOLUME" knob. 
3. Press & hold "SCAN" button for 1 second 
4. Existing channel blinks 
5. Press & release "SCAN" button 
6. New interference-free channel appears 

**AUTOMATIC "TRANSMITTER" SYNC**

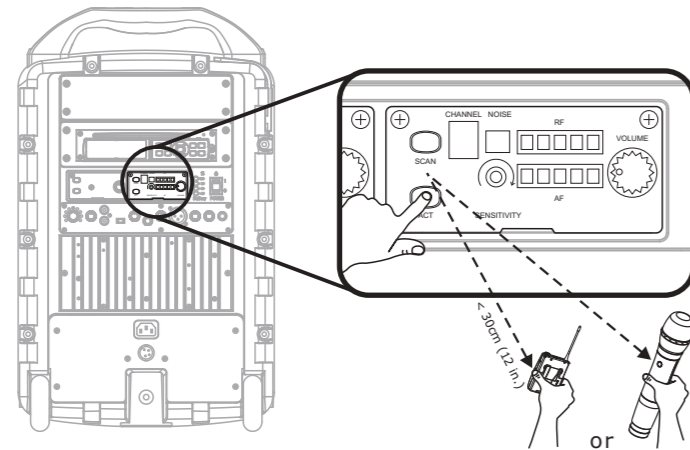

1. POWER on transmitter (ensure fresh batteries are properly installed with the correct polarity). Replace transmitter battery when LED glows red during powered-on. (glows red = low battery)
2. Locate and bring an ACT transmitter \*infrared (IR) port within 30cm (12-inch) of receiver's ACT button.
3. Press and release "ACT" button to synchronize transmitter and receiver frequencies.
4. When the frequencies are synchronized successfully the receiver channel stops flashing and the RF meter is fully lit, the microphone is now ready for use.

**NOTE:** The transmitter infrared IR port is normally located by a round-shaped red color spot.

**WIRELESS INTERLINKING TRANSMITTER AND RECEIVER MODULES**

Users have options to add a single MTM-90/MTM-92 wireless transmitter or MRM-72/MRM-72B receiver module in this slot.

**MRM-72/MRM-72B receiver module consists of 2 MRM-70/MRM-70B receiver modules side-by-side.**

The purpose of MTM-90/MTM-92 wireless interlinking transmitter is to interlink multiple MIPRO MA-708 portables wirelessly to greatly extend the transmission range and expand coverage.

**MTM-90/MTM-92 Wireless Interlinking Transmitter**

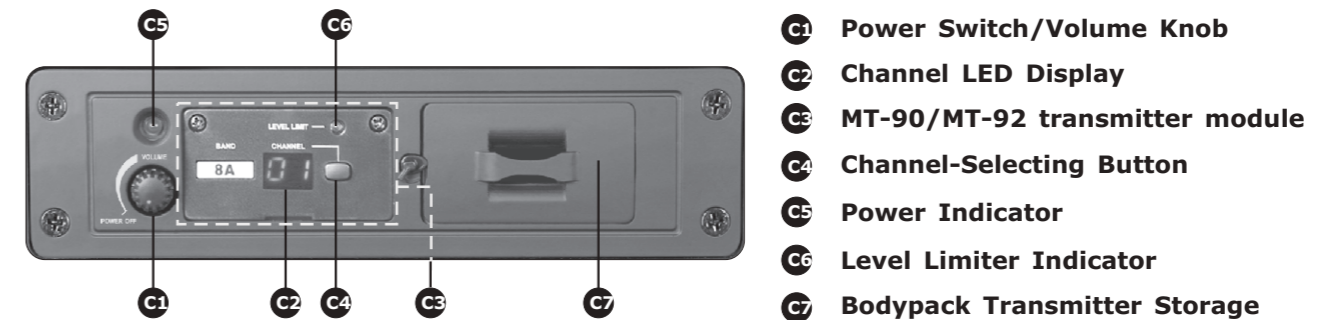

**INSTALLATION OF MTM-90/MTM-92 WIRELESS INTERLINKING TRANSMITTER**

- Using a Phillips-head screwdriver (not supplied) remove the screws to remove protection cover panel.
- Gently insert the transmitter module into the slot. Make sure the back edge connector is aligned and firmly connected.
- Tighten up the screws.

**OPERATION INSTRUCTIONS OF MTM-90/MTM-92 WIRELESS INTERLINKING TRANSMITTER**

**Power On/Off:**

Turn the transmitter power/volume switch **C1** to ON by rotating the knob clockwise. When ON, the power indicator **C5** and Channel LED Display **C2** will be lit. Rotate volume knob **C1** clockwise to adjust the desired volume. Rotate same volume knob **C1** counterclockwise to power OFF the transmitter.

**Select Channels:**

1. **To select a channel one at a time:** Press and hold the Channel-Selecting button **C4** for around 2 seconds and release when channel LED display **C2** starts flashing. Press and release button once to move to the next available channel. If button is not pressed again when Channel LED flashes 6 times, the channel appearing in Channel Display is automatically saved and set.
2. **To select channel continuously:** Press and hold the Channel-Selecting button **C4** for around 2 seconds until channel LED display **C2** starts flashing. Press and hold same button will automatically advance channel continuously until stopped. There are a total of 16 preset channels. If button is not pressed again when Channel LED flashes 6 times, the channel appearing in Channel Display is automatically saved and set.

The Level Limiter Indicator will not be lit under normal audio volume. If the audio input exceeds the set limitations, volume restriction control will activate and the indicator will lit. Adjust volumes to an acceptable levels.

**MTM-90/MTM-92 COMPARTMENT FOR BODYPACK TRANSMITTER**

Compartment holds and stores one body pack transmitter.

Storing the body pack transmitter:

- A** Locate the compartment fastener on the left hand side.
- B** Turn fastener clockwise to loose the compartment door.
- C** Gently pull the compartment door away from the slot.
- D** Slide the back of the bodypack transmitter into the back of the compartment door in position, carefully keep the antenna in horizontal position to prevent from being squeezed.
- E** When secured, push in the compartment door back into the slot.
- F** Turn fastener counter clockwise to secure the compartment door.

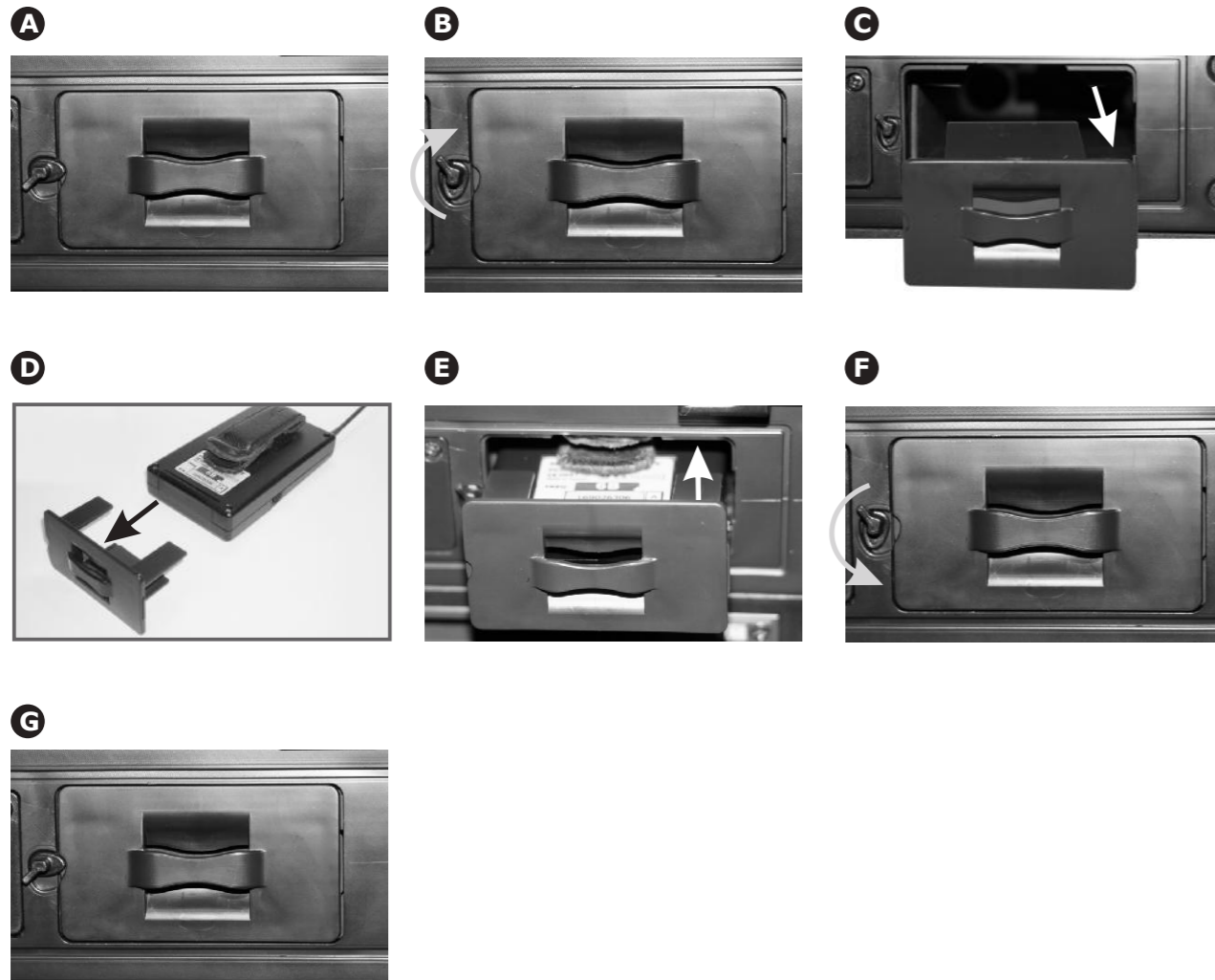
**INSTALLATION OF MIPRO CD/MP3 PLAYER**

- Using a Phillips-head screwdriver (not supplied) remove the screws to remove protection cover panel. (see figure 2-1)
- Gently insert the CD/MP3 player module into the slot. Make sure the back edge connector is aligned and firmly connected. (see figure 2-2)
- Tighten up the screws. (see figure 2-3)

(Figure 2-1)



(Figure 2-2)



(Figure 2-3)

**OPERATIONS OF CD/MP3 PLAYER**

See a separate CD player manual enclosed in the master carton.

**HELPFUL OPERATING TIPS**

1. We recommend placing sound system between the target audience and the presenter, facing the audience and raised above their heads using a speaker stand or table. This set-up helps prevent the annoying feedback by keeping wireless & wired microphone users behind the sound system. The internal power supply rechargeable, lead-acid batteries should be kept fully charged. Always charge the system after use.
2. Minimized all the volumes before powering on.
3. Each audio input is accepted through amplifier and its volume can be controlled separately.
4. Each audio input can be broadcasted and recorded at the same time.
5. This speaker fits into a standard speaker tripod stand. For optimal usage, operate the wireless microphones from a distance behind or beside the speaker to avoid the undesirable feedback.
6. Do not expose the MA-708 to an environment where there are water dropping or splashing.
7. Before turning power ON to the unit, please set all volume controls to their minimum level. This prevents any loud 'thumps' at power on. Adjust the volume controls afterward.
8. NEVER place any microphone in front or close in front of the speaker otherwise damaging feedback (both to the operators ears and the system) could occur.
9. The MA-708 features a retractable handle and wheels for easy transport. However, DO NOT pull the unit for long distances or over uneven or rough surfaces. And, DO NOT pull it up or down stairs. Vibration caused by long distance travel or traveling over uneven surfaces may result in function failure not covered by warranty.
10. The MA-708-EXP extension speaker is rated at 120 watts @ 4 ohms. Please take care not to short out the speaker cables otherwise unwarranted damage could be done to the system amplifier.

**TROUBLESHOOTING-PORTABLE PUBLIC ADDRESS**

PROBLEM	POSSIBLE CAUSE	SOLUTION
No Sound or Faint Sound From Speaker	Volume turned down	Adjust volume
	Power switch is turned off	Turn power switch on
Power Indicator Not On	Power switch is turned off	Turn power switch on
	Rechargeable Battery is discharged	Plug into AC outlet to recharge
	Rechargeable Battery is "dead"	Replace battery and plug into AC outlet to recharge
Distorted Sound From Speaker	Volume set too high	Reduce volume
	Excessive wind noise or breath "pops"	Use windscreen on wireless & wired microphones.
	Input signal too strong	Adjust input signals
Excessive Feedback	Microphone too close or directly in front of the speaker	Move microphone away from the speaker
	Volume set too high	Reduce volume
	Microphone too far from sound source (requiring the volume to be turned up to compensate)	Speak closer to the microphone or move microphone closer to sound source
	Batteries level is low	Plug into AC outlet to recharge
Excessive Hum or Noise	Input Cable not shielded	Use shielded cable
Shortened Battery Life	Old or overused battery	Recharge or replace battery
	Battery is not charged for over 3~4 months	Recharge or replace battery
Battery CHARGE Indicator Not Flickering when plugged into AC Outlet	Rechargeable Battery is "dead"	Replace battery
	Battery is not charged for over 3~4 months	Recharge or replace battery
	Battery is fully charged (CHARGE indicator is lit)	N/A

**TROUBLESHOOTING-WIRELESS MICROPHONE SYSTEMS**

PROBLEM	POSSIBLE CAUSE	SOLUTION
No Sound From Speaker	Master or receiver volume turned down	Adjust volumes
	Transmitter or receiver switch is turned off	Turn transmitter or receiver switch on
	Receiver and transmitter have different frequencies	See "Set-up Receiver & Transmitter Frequencies" section
	Transmitter battery is low or no battery inside	Replace or insert new battery
	Headset or lavalier microphone is not plugged into bodypack transmitter	Plug headset or lavalier microphone into bodypack transmitter
Distortion or Unwanted Noise Bursts	Interference	Remove nearby sources of RF interference (computers, amplifiers, karaoke machines, digital effects, CD players, etc)
	Noise Indicator is lit (MRM-70/72 receiver) (MRM-70B/72B receiver)	Adjust "Sensitivity" on MRM-70/70B/72/72B receiver. If problem persists, change Receiver & Transmitter frequencies.
		See "Set-up Receiver & Transmitter Frequencies" section
Sound Dropouts	Out of operating range	Move transmitter closer to receiver
	Obstructions between the receiver and transmitter	Remove obstructions or reposition
		Line-of-sight between receiver & transmitter
	Weak Transmitter Battery	Replace Transmitter Battery
	Interference	Change Receiver & Transmitter frequencies
See "Set-up Receiver & Transmitter Frequencies" section		

**FAQ - PORTABLE PA****Q: Why is my MA-808 not recharging (battery meter is not flashing)?**

A: Plug one end of the included AC cord into the 12 AC Input Socket and the other end into an AC outlet. Normal charging starts once indicators in the battery meter is flashing.

A: The built-in rechargeable batteries life has ended. Replaced with new, fresh charged batteries.

**Q: How to adjust for optimal sound volume?**

A: If the portable system has both Master & Microphone volumes, we recommend turning the Master volume to about 2~3pm (clockwise) first and about 1~2pm (clockwise) for Microphone or other volumes.

**Q: How to prevent and minimize the annoying feedback?**

A1: Do not stand directly in front of the speakers; keep mics away from speakers.

A2: Avoid pointing microphone towards the speakers.

A3: The microphones should be behind the speakers wherever possible.

A4: Locate the portable PA between the crowd and the presenters and facing the crowd.

A5: Turn down the sound level coming out of the portable PA / speakers if necessary.

A6: Place the speakers above the head of the crowd.

**Q: What if I need more power to cover a larger crowd?**

A: Two or more portables can be used with one wireless microphone transmitter. Ascertain that the receiver frequency in each portable coincides with the wireless microphone.

**Q: Can I play music through the systems?**

A: Yes. All MIPRO portables have auxiliary inputs (3.5mm min-jack, RCA or 1/4"phone), which will accept input from an external iPod, MP3, CD, cassette, VCR, DVD players. As well, modular CD players can be inserted into most models.

**FAQ - RECHARGEABLE BATTERY****Q: How to Charge the Battery?**

A: Simply plug the AC power cord into an AC outlet. "Flashing" LED indicators are flashing up-and-down to denote normal charging status. The main power switch can be on or off position during charging. Microphones or music can be used during charging & power is on.

**Q: How to Spot System Low Battery?**

A: When Power LED is lit (MA-705 & MA-707) or Charge LED is lit (MA-101, MA-101a, MA-101A & MA-101B) or one indicator remaining in battery meter (MA-100, MA-202, MA-202B, MA-303, MA-505, MA-708, MA-808). Plug into an AC outlet to re-charge immediately.

**Q: Average Life Span of Sealed Lead-Acid Rechargeable Battery?**

A: The batteries should have a life of approx. 2~3 years if used and maintained properly. Battery life is determined by temperature, depth and rate of discharge, and the number of charges and discharges (called cycles).

**Q: When to Replace the Battery?**

A1: Power LED indicator is not "lit" when power on. (No battery voltage).

A2: LED indicator or meter is not "flashing" when plugged-in.

A3: Getting 1~2 hours operating time per charge.

A4: When battery has been used extensively for 2~3 years or more.

**Q: Should batteries be kept in the handheld or bodypack transmitters when not in use?**

A: Do not leave old batteries in the transmitters if it will not be used for a long time. Batteries could leak or corrode and damage the internal PCB of the transmitters.

**RECHARGEABLE BATTERY GUIDE****Tips - To Prolong the Life of Rechargeable Batteries**

- Always charge the batteries before first and after use.
- Always store portable system with batteries in a fully charged condition.
- Always power off the portable system and transmitter/mic when NOT in use.
- It is OK to leave the system plugged into a power outlet when not being used for a long time. The built-in automatic protection circuitry will auto shut-off when fully charged. It will not harm the system or the battery.
- Fully charge the system at least once every 3 months. Battery may not charge if not charged for a prolonged periods of time.
- Store in dry, cool place away from heat. Elevated temperature reduces longevity.
- CAUTION: DO NOT recharge other types of batteries and connect a battery's negative terminal to another batteries positive terminal. An explosion and/or a fire could occur as a result. Use only rechargeable sealed lead-acid (gel cell) batteries.

**OPTIONAL MA-708 ACCESSORIES****MA-708EXP: Extension Speaker for MA-708**

Unpowered extension speaker (10-meter speaker cable included)

**MB-70: 12V/4.5AH Rechargeable Battery**

Gell-cell (Sealed lead-acid) type rechargeable battery (MA-708 requires 2 MB-70 batteries)

**MB-80: LiFePo4-LFP Battery Case****MS-70: Speaker Tripod Stand**

Adjustable stand for MA-708 portable PA system

**SC-75: Storage Cover**

Storage cover and separate storage for mic cable, transmitters, microphone & battery

**MM-107: Handheld Wired Microphone**

MIPRO's Hypercardioid Dynamic Microphone with cable.

**CDM-2: CD/USB Player**

Plays standard 12cm (5") audio CD & MP3 CD.

**DPM-3: Digital Audio Player Recorder****ASP-10: Aerobic Sports Pouch**

Sweat-resistant transmitter pouch belts for MIPRO bodypack transmitters.

**MIPRO WIRELESS MICROPHONE SYSTEMS****MRM-70/MRM-72/MRM-70B/MRM-72B** UHF 16-Channel Diversity Receiver Module

(Automatic receiver frequency scan & ACT sync)

**ACT-30H/ACT-32H** Handheld Transmitter Microphone (AA x 2: not included)

**ACT-30Hr/ACT-32HR** Handheld Transmitter Microphone with volume control (AA x 2: not included)

**ACT-50T/ACT-52T** Body Pack Transmitter (AA x 2: not included)

(Headworn microphone is optional and not included - see below)

**MU-53HN (black) ; MU-53HNS (beige)** Premium Headworn Microphone

Uni-directional, Premium 10mm, Ideal for speech and vocal. Works with all MIPRO bodypack transmitters

**MU-55HN (black) ; MU-55HNS (beige)** Subminiature Headworn Microphone

Omni-directional, 4.5mm, Sweat-proof, Ideal for speech. Works with all MIPRO bodypack transmitters

**MU-13/MU-13d (beige)** Premium Single-sided Earworn Microphone

Omni-directional, ultra small & lightweight 3mm, Ideal for speech. Works with all MIPRO bodypack transmitters

**MU-23/MU-23d (beige)** Premium Dual-sided Headworm Microphone

3 mm Ø omni-directional condenser microphone. Works with all MIPRO bodypack transmitters

**MU-210/MU-210d (beige)** Premium Dual-sided Headworm Microphone

10 mm Ø uni-directional condenser microphone. Works with all MIPRO bodypack transmitters

(Lavalier microphone is optional and not included - see below)

**MU-53L (black) ; MU-53LS (beige)** Premium Lavalier Microphone

Uni-directional, 10mm, Works with all MIPRO bodypack transmitters

**MU-55L (black) ; MU-55LS (beige)** Subminiature Lavalier Microphone

Omni-directional, 4.5mm, Low visibility, Works with all MIPRO bodypack transmitters

## Notes

1. Refer to actual product in the event of product description discrepancy.
2. Frequency range and maximum deviation comply with the regulations of different countries.