



CD Player Module User Guide

CDM-2 / MCD-707









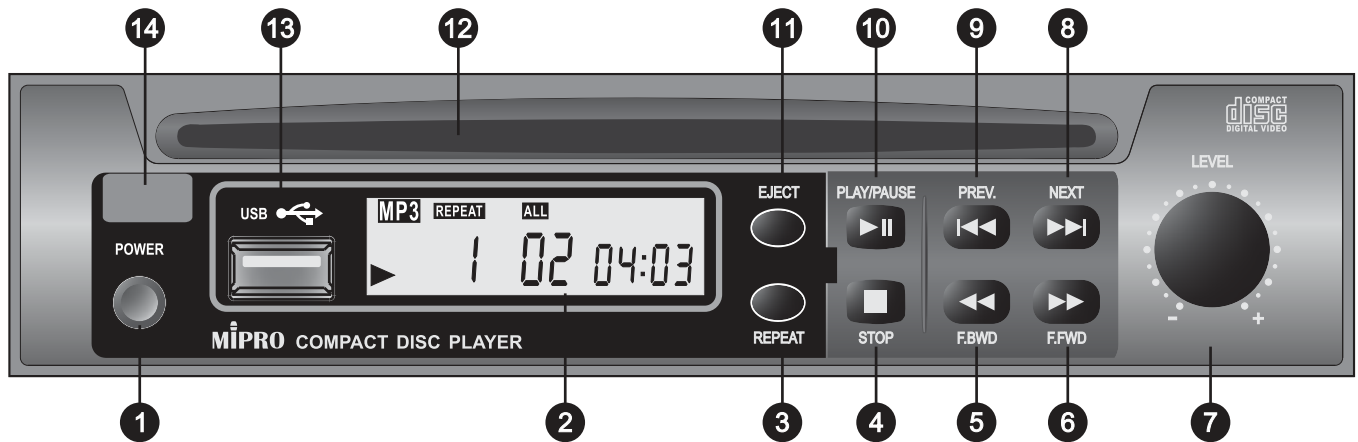

CDM-2P / MCD-707P



I. Controls and Functions

No Bluetooth



- ❶ POWER: Press once to power on (LCD on). Press again to power off (LCD off).
- ❷ LCD DISPLAY: Display CD status including track number and playing time.
- ❸ REPEAT: Repeatedly play the single track or all of the tracks.
- ❹  STOP: Stop CD disk playing.
- ❺  F.BWD: Fast backward: If pressing  ONCE, it moves backward. Fast backward available at 2X, 4X, 8X, and 20X speed. Fast backward cancels automatically when pressing PLAY/PAUSE button and player returns to the normal playing speed.
- ❻  F.FWD: SFast forward: If pressing  ONCE, it moves forward. Fast forward available at 2X, 4X, 8X, and 20X speed. Fast forward cancels automatically when pressing PLAY/PAUSE button and player returns to the normal playing speed.
- ❼ LEVEL: Volume level (rotating clockwise to increase volume; counterclockwise to reduce volume).
- ❽  NEXT: Press NEXT once to forward to the next track.
- ❾  PREV: Press PREV once to backward to the previous track.
- ❿  PLAY/PAUSE: Play and Pause. Press the button once start playing. Press the button once during playing to pause the music and again to resume playing.
- ⓫ EJECT: Press once, the CD eject from the slot; press again and the CD will be taken into the slot.
- ⓬ Disk loading slot: Insert the audio disc (label side up) into the CD loading slot gently. CD will be loaded automatically.
- ⓭ USB Port (type A): Accepts USB mass-storage device.
- ⓮ Remote control port: Aim the remote control towards this section to enable remote operation.

Bluetooth

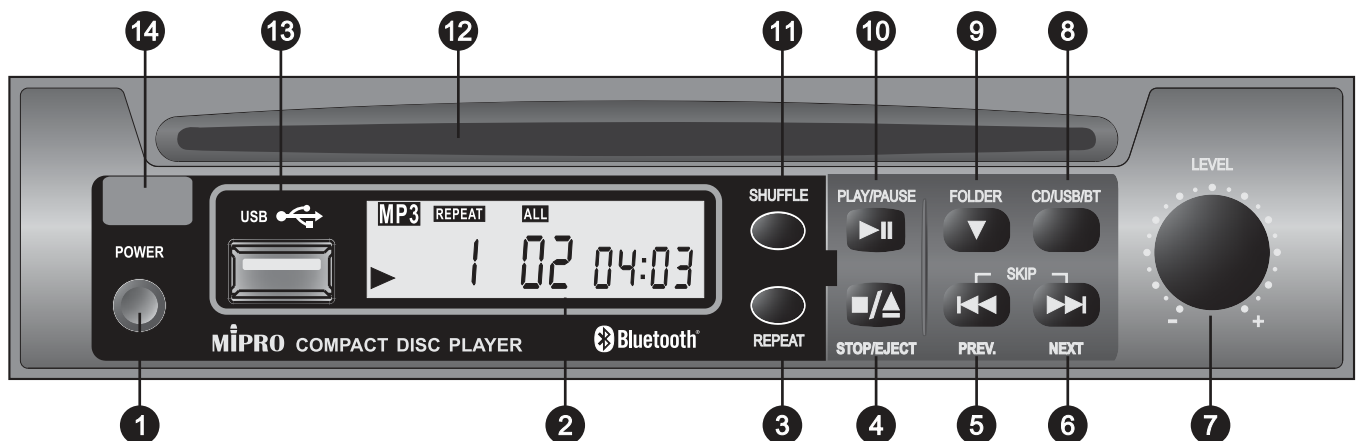

- ❶ **POWER:** Press once to power on (LCD on). Press again to power off (LCD off).
- ❷ **LCD DISPLAY:** Display CD status including track number and playing time.
- ❸ **REPEAT:** Repeatedly play the single track or all of the tracks.
- ❹ **STOP/EJECT:** Press once to stop play. Press one more time to reject the CD.
- ❺ **PREV.:** Previous track. Press once for the previous track. Press & hold to fast backward.
- ❻ **NEXT:** Next track. Press once for next track. Press & hold to fast forward.
- ❼ **LEVEL:** Volume level (rotating clockwise to increase volume; counterclockwise to reduce volume).
- ❽ **CD/USB/BT:** CD/USB/BT play options. (If CD & USB has no such function, BT (Bluetooth) is the only option)

Bluetooth Using Instructions:

- (A) Select BT from CD/USB/BT options from the music player. The word "BLUE" is displaying and flashing intermittently on the LCD screen.
- (B) Search Bluetooth devices, like smartphones or tablets or MP3 players, for the music player's ID. The device ID is the word "BLUE". Click on the device ID.
- (C) Enter "0000" when you're prompted to enter a PIN number. This will cause your wireless device to pair with the music player.
- (D) Once paired and the connection is made successfully, the word "BLUE" stops flashing and becomes still.
- (E) The Bluetooth Music Player is now connected and established. Ready to play music.
- (F) Bluetooth functions can be controlled by using the remote control by pressing PLAY/PAUSE, PREV & NEXT buttons.
- (G) Note: Effective range of up to 5 meters (15 feet) line-of-sight during typical connection and music playing. If the connection is out of range and/or signal lost for more than 10 seconds due to something blocking the Bluetooth signal, the connection may need to be reestablished by following the directions above.

- 9 FOLDER: Press for next folder.
- 10 PLAY/PAUSE: Play and Pause. Press the button once start playing. Press the button once during playing to pause the music and again to resume playing.
- 11 SHUFFLE: Press for shuffle (random) track play or use the remote control for PREV (previous) & NEXT (next) track play.
- 12 Disk loading slot: Insert the audio disc (label side up) into the CD loading slot gently. CD will be loaded automatically.
- 13 USB Port (type A): Accepts USB mass-storage device.
- 14 Remote control port: Aim the remote control towards this section to enable remote operation.

Reading the Display Screen

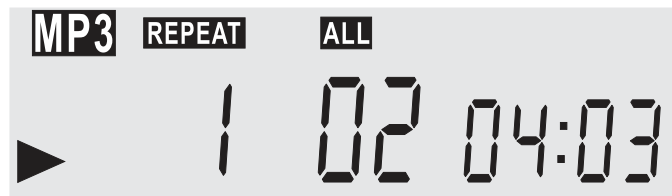

MP3 : MP3 text appears when playing MP3.

CD : CD text appears when playing a CD.

▶|| : “▶” Current track is playing; “||” current track is paused.

REPEAT 1 : Repeating current track.

REPEAT ALL : Repeating all tracks.

REPEAT FOLDER: When showing “REPEAT FOLDER” on LCD, it means to replay the current folder. (This function only works for the MP3 and other formats of the CD containing the folders)

RANDOM : When executing the RANDOM function, LCD shows “D” and flashes as well.

SHUFFLE : When executing the SHUFFLE function, LCD shows “SHUFFLE” and flashes as well.

A→B : Repeat playing between A and B.

BB : Displaying Folders Numbers.

BBB : The LCD displays the total number of folders and tracks. LCD shows the number of the folder first and then the specific number of tracks.

BB:BB : Displays elapse time.

II. Remote Controller Controls and Functions

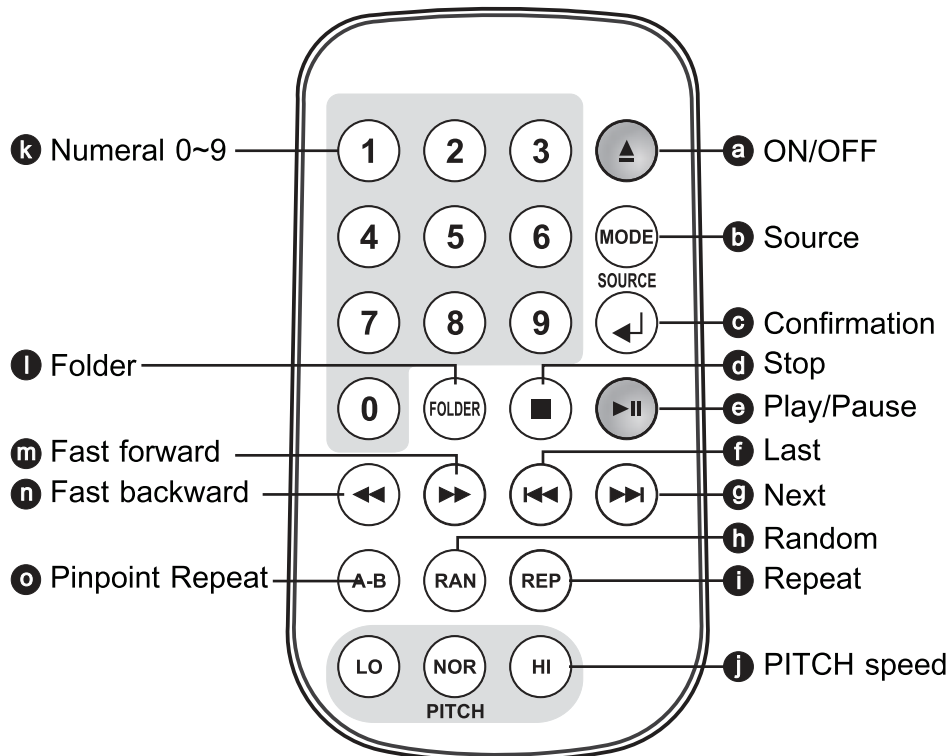

- a** ON/OFF: Load and Eject Disk.
- b** MODE: Mode selection. CD→USB→BT options. CD\USB\BT play options. (If CD & USB has no such function, BT (Bluetooth) is the only option)
- c** Confirmation button: Press for confirmation to any remote command.
- d** Stop: Stop playing.
- e** Play/Pause: Play and pause playing the disk.
- f** Last: Skip to the former track.
- g** Next: To the next track.
- h** Random: Random play. Press **RAN** and then using **◀◀** or **▶▶**, then choose the playing tracks at random.
- i** Repeat: Repeated play on each mode.

(A) CD formats in this CD player unit: When playing music, pressing REPEAT once, then the LCD displays "REPEAT 1". It refers to replaying the present track. Press REPEAT twice, LCD then shows "REPEAT ALL", which means to replay the whole available tracks. Pressing REPEAT three times, the LCD displays "CANCEL", and it refers to cancel the repeat function.

(B) MP3 and CD which meets the required formats in this CD player unit: When playing music, pressing REPEAT once, then LCD displays "REPEAT 1". It refers to replaying the present track. Press REPEAT twice, LCD then shows "REPEAT". It refers to playing all tracks within the current folder. If pressing REPEAT three times, LCD shows "REPEAT ALL", which means to replay the whole available tracks. Pressing REPEAT four times, the LCD displays "CANCEL", and it refers to cancel the repeat function.







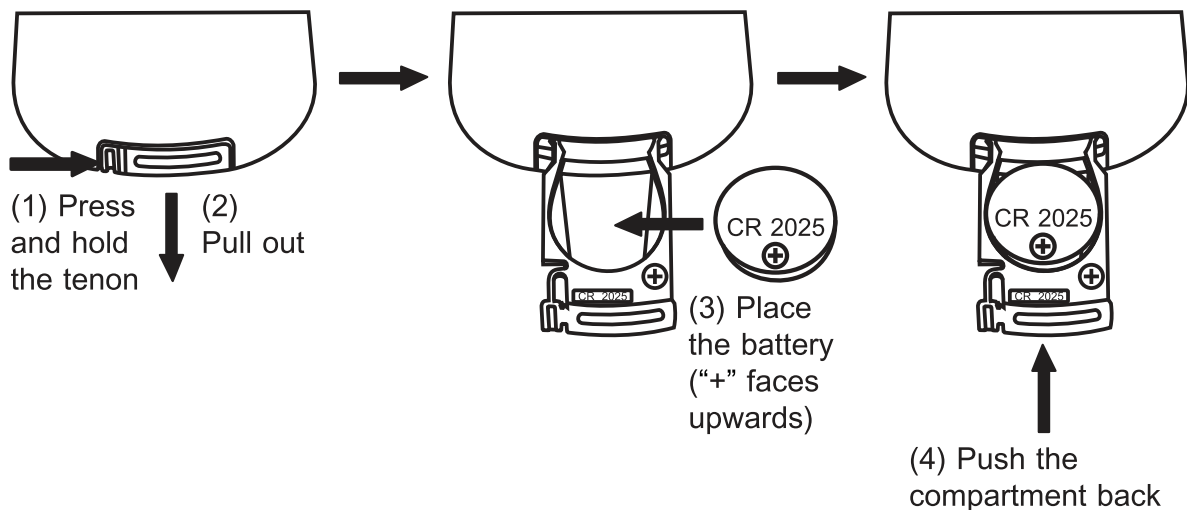

- j** PITCH speed: Allow track to increase (HI) or decrease (LO) speed and each has ten steps. (NOR) Denotes normal speed.
- k** Numeral 0~9: Select numerals.
- l** Folder: Repeat folder. When pressing the FOLDER each time, it will be changed into the next folder number.
- m** Fast forward: Press (FF) once to activate fast forward. Press (PAUSE) to resume normal play.
- n** Fast backward: Press (FB) once to activate fast backward. Press (PAUSE) to resume normal play.
- o** Pinpoint Repeat: Pinpoint repeat playing between A and B.

Battery Installation of the Remote Control

- (A) Locate the battery compartment on the bottom of the remote control.
- (B) Press and hold tenon and then slide out the battery tray.
- (C) Remove the old battery and insert the new battery in, making sure that the battery's positive (+) side is facing up.
- (D) Slide the battery tray back into the remote control until it clicks.
- (E) * * Note: The effective transmission range is 3~5 meters. Use only a CR2025 3V lithium battery.



III. Playing Audio Disc

1. This player can accept WMA, CD, CD-R, CD-RW, MP3 disks, and USB reader playing.
2. Insert a disc into the disc slot with the playback side down and playback starts automatically. Track number and playing time will be displayed.
3. Press PREV, NEXT on the front display panel or   on the remote control, for desired next or previous track number.
4. Press PLAY/PAUSE and  on the remote control, for users to begin to play and pause the track.
5. Press STOP on the front display panel or  on the remote control, for users to stop the playing track.
6. Press EJECT on the front display panel or  on the remote control, for users to have the CD ejected; if pressing one more time, the CD will be taken into the slot.
7. Button  and  on the remote control are for users to fast forward or backward.
8. To select the various folders in MP3 format, it can be done by pressing  on the remote control to choose the desired folder. Then combine the respective number buttons to form the playing track within the desired folder.
9. Two options for the order of playing music:
 - (A) Format USB before playback. Format standard is FAT.
 - (B) Copy the desired songs into the USB storage unit one by one until copying all the desired songs. In this way, the play sequence will be based upon the order of music being programed into the USB storage unit.
 - (C) If the desired songs will be divided into different folders, please number the songs when copying them into folders then copy the said folders into the USB storage unit. Please note the songs must be numbered by the same digit like 00, 01, 02 or 000, 001, 002 or 0000, 0001, 0002... and so on.
10. Note: When inserting the disk into a CD player or taking out the disk, it is necessary to let the CD player insert the disk and return it automatically. It is prohibited to push or take out the disk by hand before the disk completely returns from the CD player, thus it will cause the machine to be broken down and unable to operate normally.

IV. Rear Panel Wiring Connection

(2-Wire)

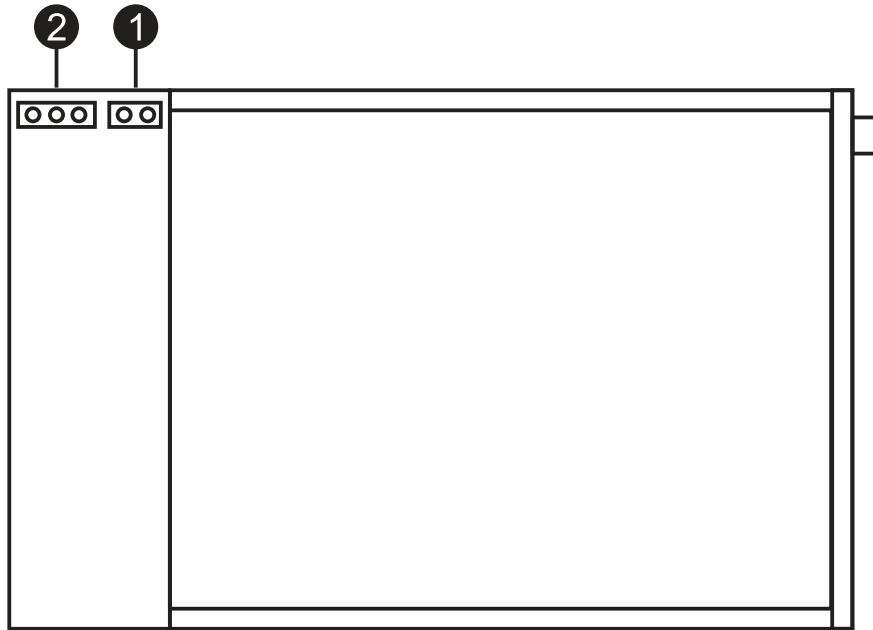

- ① Power input
- ② Audio Output Connector Balanced

(1-Wire)

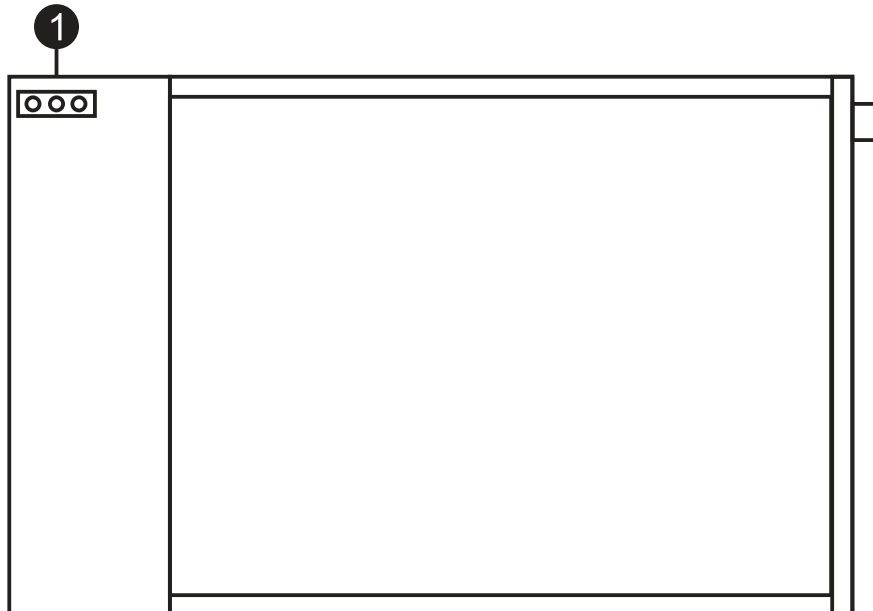

- ① Power input and Audio output

V. Notes

1. Do read this user guide before use.
2. Do not hit the player.
3. Do not place this player near strong magnetic fields and electric fields.
4. Do not disassemble, repair or modify this player.
5. Changes to the characteristics and design of the product will be made without notice.

WARNING

1. **FOR OUTDOOR USE:**
To reduce the risk of fire or electric shock, do not expose this apparatus to rain or moisture.
2. **UNDER WET LOCATION:**
Apparatus should not be exposed to dripping or splashing and no objects filled with liquids, such as vases should be placed on the apparatus.
3. **SERVICE INSTRUCTIONS:**
CAUTION - These servicing instructions are for use by qualified service personnel only. To reduce the risk of electric shock, do not perform any servicing other than that contained in the operating instructions unless you are qualified to do so.

CAUTION

RISK OF ELECTRIC SHOCK
DO NOT OPEN

This symbol indicates that dangerous voltage constituting a risk of electric shock is present within this unit.

This symbol indicates that there are important operating and maintenance instructions in the literature accompanying this unit.

FC & IC - ID

THIS DEVICE COMPLIES WITH PART15 OF THE FCC RULES AND RSS-123 ISSUE2 OF CANADA. OPERATION IS SUBJECT TO THE FOLLOWING TWO CONDITIONS:

- (1) This device may not cause interference.
- (2) This device must accept any interference, including interference that may cause undesired operation of the device. This equipment complies with FCC RF radiation exposure limits set forth for an uncontrolled environment.



“This product can only be used at the area that the altitude is lower than 2000m for safety purpose.”



“This product can be used in non-tropical locations only for safety purpose.”

Disposal Dispose of any unusable devices or batteries responsibly and in accordance with any applicable regulations.



Disposing of used batteries with domestic waste is to be avoided!

Batteries / NiCad cells often contain heavy metals such as cadmium(Cd), mercury(Hg) and lead(Pb) that makes them unsuitable for disposal with domestic waste. You may return spent batteries/ accumulators free of charge to recycling centres or anywhere else batteries/accumulators are sold.

2005-08-13

By doing so, you contribute to the conservation of our environment!

MIPRO[®]
MICROPHONE PROFESSIONALS

MIPRO Electronics Co., Ltd

Headquarters: No. 814, Beigang Rd., Chiayi City 600079, Taiwan

Tel : +886.5.238.0809

Fax : +886.5.238.0803

www.mipro.com.tw

mipro@mipro.com.tw

All rights reserved. YM 022/04

Do not copy or forward without prior approvals of MIPRO.

Specifications and design subject to change without notice.



2CE360F