

Rev. 2.0.0
Item no. OM-CSX

C SERIES

Dedicated Installation Amplifiers



C 20:8 X
C 10:8 X
C 10:4 X
C 5:4 X

LAB.GRUPPEN

Operation Manual

1. Important safety instructions

Before using the device, be sure to carefully read the Safety Instructions. Keep this document with the device at all times.

1. Read these instructions.
2. Keep these instructions
3. Heed all warnings.
4. Follow all instructions.
5. Do not use this apparatus near water.
6. Clean only with a dry cloth.
7. Do not block any ventilation openings. Install in accordance with the manufacturer's instructions.
8. Do not install near any heat sources such as radiators, heat registers, stoves, or other apparatus (including amplifiers) that produce heat.
9. Do not defeat the safety purpose of the polarized or grounding-type plug. A polarized plug has two blades with one wider than the other. A grounding-type plug has two blades and a third grounding prong. The wide blade or the third prong is provided for your safety. If the provided plug does not fit into your outlet, consult an electrician for replacement of the obsolete outlet.
10. Protect the power cord from being walked on or pinched, particularly at plugs, convenience receptacles, and the point where they exit from the apparatus.
11. Only use attachments/accessories specified by the manufacturer.
12. Use only with a cart, stand, tripod, bracket, or table specified by the manufacturer, or sold with the apparatus. When a cart is used, use caution when moving the cart/apparatus combination to avoid injury from tip-over.
13. Unplug this apparatus during lightning storms or when unused for long periods of time.
14. Refer all servicing to qualified service personnel. Servicing is required when the apparatus has been damaged in any way, such as power-supply cord or plug is damaged, liquid has been spilled or objects have fallen into the apparatus, the apparatus has been exposed to rain or moisture, does not operate normally, or has been dropped.
15. Use the mains plug to disconnect the apparatus from the mains.
16. **WARNING:** To reduce the risk of fire or electric shock, do not expose this apparatus to rain or moisture.
17. Do not expose this equipment to dripping or splashing and ensure that no objects filled with liquids, such as vases, are placed on the equipment.
18. Do not connect the unit's output to any other voltage source such as battery, mains source, or power supply, regardless of whether the unit is turned on or off.
19. Do not remove the top (or bottom) cover. Removal of the cover will expose hazardous voltages. There are no user serviceable parts inside and removal may void the warranty.
20. An experienced user shall always supervise this professional audio equipment, especially if inexperienced adults or minors are using the equipment.
21. The US National Differences clause 16.3 requires that network cables must be flame rated VW-1.



1.1. Approvals



This equipment conforms to the requirements of the EMC Directive 2014/30/EC and the requirements of the Low Voltage Directive 2014/35/EC.

Standards applied: EMC Emission EN55103-1, E3
EMC Immunity EN55103-2, E3, with S/N below 1% at normal operation level.
Electrical Safety EN60065, Class I



This equipment is tested and listed according to the U.S. safety standard ANSI/UL 60065 and Canadian safety standard CSA C22.2 NO. 60065. Intertek made the tests and they are a Nationally Recognized Testing Laboratory (NRTL).

1.2. Warnings

1.2.1. Explanation of warning symbols



The lightning bolt triangle is used to alert the user to the presence of un-insulated "dangerous voltages" within the unit's chassis that may be of sufficient magnitude to constitute a risk of electric shock to humans.



The exclamation point triangle is used to alert the user to presence of important operating and service instructions in the literature accompanying the product.

1.2.2. Warnings

To prevent electric shock do not remove top or bottom covers. No user serviceable parts inside, refer servicing to qualified service personnel.

Français: À prévenir le choc électrique n'enlevez pas les couvercles. Il n'y a pas des parties serviceable à l'intérieur, tous reparations doit être faire par personnel qualifié seulement.



 To completely disconnect this equipment from the AC mains, disconnect the power supply cord plug from the AC receptacle. The mains plug of the power supply cord shall remain readily operable.

Français: Pour démonter complètement l'équipement de l'alimentation générale, démonter le câble d'alimentation de son réceptacle. La prise d'alimentation restera aisément fonctionnelle.

 To reduce risk of fire or electric shock, do not expose this apparatus to rain or moisture.

Français: Pour réduire les risques d'incendie ou de choc électrique, n'exposez pas l'appareil à la pluie ou à l'humidité.

 Do not expose this system/apparatus to dripping or splashing and ensure that no objects filled with liquids, such as vases, are placed on the apparatus.

Français: N'exposez pas ce système/appareil au ruissellement ni aux éclaboussures et assurez-vous qu'aucun objet contenant du liquide tel qu'un vase n'est placé sur l'appareil.

 This apparatus must be connected to a mains socket outlet with a protective earthing connection.

Français: Cet appareil doit être raccordé à une prise secteur avec terre de protection.

 The mains plug is used as a disconnect device and shall remain readily operable.

Français: Lorsque la prise du réseau d'alimentation est utilisée comme dispositif de déconnexion, ce dispositif doit demeurer aisément accessible.

1.2.3. Caution

To reduce the risk of fire or electric shock, do not remove screws.

 No user-serviceable parts inside. Refer servicing to qualified service personnel.

Français: Pour réduire le risque d'incendie ou de choc électrique, ne pas retirer les vis. Aucune pièce réparable par l'utilisateur. Confier l'entretien à personnel qualifié.

1.2.4. User responsibility

Mains connection grounding

 Your amplifier must be connected to a grounded socket outlet.

Speaker output hazard on amplifiers

 Amplifiers are capable of producing hazardous output voltages. To avoid electrical shock, do not touch any exposed speaker wiring while the amplifier is operating. The external wiring connected to the speaker terminals shall be installed by a qualified person, or ready-made leads or cords of appropriate capacity shall be used.

 As the power output channels on amplifiers produce high voltage, do not connect or disconnect speaker cables when the mains power is on.

Radio interference

A sample of this product has been tested and complies with the limits for the European Electro Magnetic Compatibility (EMC) directive. This equipment has also been tested and found to comply with the limits for a Class A digital device, pursuant to Part 15 of the FCC Rules. These limits are designed to provide reasonable protection against harmful interference from electrical equipment. This product uses radio frequency energy and if not used or installed in accordance with these operating instructions, may cause interference to other equipment, such as radio receivers.

This Class A digital apparatus complies with Canadian ICES-003.
Cet appareil numérique de la classe A est conforme à la norme NMB-003 du Canada.

However, there is no guarantee that interference will not occur in a particular installation. If this equipment does cause harmful interference to radio or television reception, which can be determined by turning the equipment on and off, the user is encouraged to try to correct the interference by one or more of the following measures:

- Reorient or relocate the antenna.
- Increase the separation between the equipment and receiver.
- Connect the equipment to an outlet on a circuit different from that to which the receiver is connected.
- Check if the affected unit complies with the EMC limits for immunity, (CE-labeled). If not, address the problem with the manufacturer or supplier. All electrical products sold in the EC must be approved for immunity against electromagnetic fields, high voltage flashes, and radio interference.
- Consult the dealer or an experienced radio/TV technician for help.

Speaker damage

Amplifier apparatus is very powerful and can be potentially dangerous to both loudspeakers and humans alike. Many loudspeakers can be easily damaged or destroyed by overpowering them. Always check the speaker's continuous and peak power capabilities. Although the amplifiers attenuators can be used to reduce the overall gain, an increase of the input signal can result in full output power, which may cause damage to connected speakers.

Maintenance

For safe and reliable operation, the dust filters on both sides of the front panel, behind the grilles, should be removed and cleaned regularly to ensure maximum airflow through the device.

If the dust filters are not maintained there will be safety risks; for example, high internal temperatures could ignite the dust and start a fire. There is also a risk that the unit will malfunction since it is dependent on constant airflow from front to rear. If the dust filters are not clean and the unit malfunctions, any resulting problems will not be covered by the warranty.

Table of Contents

1. Important safety instructions	2
1.1. Approvals	2
1.2. Warnings	2
2. Introduction	5
2.1. Welcome	5
2.2. Main Features	6
3. Installation	9
3.1. Unpacking	9
3.2. Mounting	9
3.3. Cooling	9
3.4. Operating Voltage	10
3.5. Grounding	10
4. Product Overview	11
4.1. Front Panel Overview	11
4.2. Rear panel	13
4.3. NomadLink / Ethernet network setup	14
5. Operation and performance	16
5.1. Introduction	16
5.2. Operation precautions	16
5.3. Signal flow and headroom	16
5.4. Audio Input and Output connections	17
5.5. GPIO connection and operation	22
5.6. Protection, faults and warnings	23
5.7. NomadLink network and DeviceControl software	28
6. Appendix	32
6.1. Maintenance	32
6.2. FAQ	32
6.3. Additional documentation	33
6.4. Current Draw and Thermal Dissipation Specifications	34
6.5. Signal flow and VPL to output measurements	38
7. Technical Specifications	39
8. Warranty and Support	40
8.1. General	40
8.2. Technical assistance and service	40

2. Introduction

2.1. Welcome

Thank you for choosing LAB GRUPPEN C Series power amplifiers for your sound reinforcement system installation. We are confident that you will be very pleased with the performance, configuration flexibility, reliability, and long-term durability offered by the C Series products.

This manual provides a comprehensive guide to the features and functionality specifically of C Series model C 20:8X, C 10:8X, C 10:4X and C 5:4X amplifiers. Please read through it in its entirety to become fully acquainted with the many configuration options and multiple layers of protection circuitry.

To facilitate timely installation and use of this C Series product, we have included a Product Overview (section 4). This brief summary, in conjunction with Installation (section 5), contains the basic information needed to safely install the amplifier and place it in service. However, we highly recommend reading through this manual in its entirety, beginning with Main Features and Technologies and continuing through Operation and Performance. As you become thoroughly familiar with all aspects of operation, you may learn of features or options that will affect your choices on amplifier modes or loudspeaker system configuration.

LAB GRUPPEN C Series power amplifiers are designed and built specifically for the unique demands of permanent installation applications. C Series amplifiers offer the optimum combination of high-quality audio reproduction, flexible features, ease of installation, and ultimate reliability in normal use.

By packing four or eight channels of reconfigurable power amplification into a 2U chassis, the C Series achieves unprecedented power and channel density. The benefits of compact dimensions include reduced rack space requirements and minimal heat build-up. The flexible output stages enable each amplifier channel to be set for either low impedance or constant voltage (70 Vrms / 100 V peak) mode. NomadLink, an easy-to-use network for monitoring and control, is implemented as a standard feature on all C Series amplifiers.

Although C Series features and facilities are tailored to installation applications, at the heart of each amplifier is the same advanced technology that has made LAB GRUPPEN the benchmark of quality for touring concert systems: exceptional sonic performance, rugged construction, proven reliability, and protection features that anticipate every unwelcome possibility.



NOTE: This manual is shipped with amplifiers carrying the C...X designation (C 20:8X, C 10:8X, C 10:4X and C 5:4X). These four models within the C Series are distinguished by both four- and eight-channel versions, lower power output, and several added features. Any references to “C Series” in this manual also apply to the other models in the Series. References that apply only to the C...X models will specify “C...X amplifiers”. An alternate operation manual is shipped with model C88:4, C 68:4, C 48:4, C 28:4 and C 16:4 amplifiers.

2.2. Main Features

Your new C Series amplifier incorporates a number of sophisticated technologies – many of them proprietary to LAB GRUPPEN – that are provided to ensure the best possible performance and many years of reliable operation. Familiarizing yourself with these technologies will prove invaluable in setting up and optimizing your loudspeaker system.

2.2.1. Class D output stage and universal power supply with PFC

All C...X amplifiers employ a unique Class D output stage that is ideally matched to the lower power outputs of these amplifiers. The original C Series amplifiers, with power output up to 8800 watts total, require use of LAB GRUPPEN's patented Class TD in order to maintain sonic purity and high efficiency; however, at the lower power levels of the C...X models, LAB GRUPPEN's advanced Class D circuit offers the same performance benefits in a more cost effective manner.

C...X amplifiers also incorporate a newly developed universal switching power supply which accepts any voltage from 100-240 V (+/- 10%) @ 50 or 60 Hz. A Power Factor Correction circuit stabilizes current draw under changing conditions.

2.2.2. Amplifier gain

For greater flexibility in system integration, C...X amplifiers allow gain adjustment from +29 to +38 dB in 3 dB steps. If the input signal is weak, the gain can be boosted to maintain maximum power output while avoiding a poor signal-to-noise ratio. This gain adjustment feature makes it easier to achieve an optimal balance between headroom and noise floor.

2.2.3. Voltage Peak Limiter (VPL)

The Voltage Peak Limiter (VPL) feature allows user adjustments that determine maximum voltage output, thus matching the amplifier to the connected speaker load. Whether the connected load is low-impedance (2 to 16 ohms) or high-impedance (70 Vrms / 100 V peak), the VPL feature can be set to ensure that neither temperature nor current limitations are exceeded before reaching the desired voltage threshold.

2.2.4. Protection and performance optimization

Appropriate and reliable power amplification is vital to any audio system. Inadequate or faulty power amplification could cause damage to the loudspeakers, or in some cases to the power amplifiers themselves. To prevent any damage or costly service interruptions, C Series amplifiers offer advanced features to protect both internal circuits and any connected loads. These features even protect the mains fuse that, in extreme cases, could be overloaded.

Following are short descriptions of standard built-in C Series protection features:

- **CPL** (Current Peak Limiter) ensures that the amplifier's output does not exceed the safe current handling parameters of amplifier components.
- **Temperature protection** ensures that the amplifier will not be damaged by exceeding thermal limits.
- **PAL** (Power Average Limiter) limits the maximum average power consumption according to the power supply and mains-breaker capabilities.
- **VHF** (Very High Frequency) protection circuits mute the output of the amplifier when nondynamic continuous signals above 10 kHz are detected.
- **DC protection** ensures destructive DC signals will not appear at the amplifier outputs. If such conditions occur an internal fuse opens and fault indication is displayed.
- **Low-impedance** (short circuit) protection provides a fault warning indication and shuts down the output stage when, for example, an input signal is present and a malfunctioning cable or driver is short circuiting the output.
- **High-impedance** warning reports an alert when, at the same time, output signal is high and no current draw is measured. This situation might occur when no speakers are connected, or when a driver is blown.
- **Low inrush current** ensures that the mains breaker will not trip when several power amplifiers are turned on simultaneously.

2.2.5. GPIO facilities and 35 Hz HPF

LAB GRUPPEN C...X amplifiers offer two features that provide greater flexibility and reliability in fixed installations: GPIO (General Purpose Input / Output) facilities and a 35 Hz high-pass filter.

The GPIO connections allow seamless interfacing with many third-party control and power sequencing systems. In combination with the rear panel DIP-switch, the GPIO connections allow change-of-state power toggling from two inputs (each closure toggles on-to-off or off-to-on), or same-state on/off from a single input (closed = on and open = off). A second DIP-switch disables the power on/off commands from the NomadLink network, allowing only GPI contact closures to trigger power on/off commands.

The 35 Hz high-pass filter rolls off low frequencies (6 dB/octave) for greater efficiency and reliability in, for example, 70/100 V high impedance systems where the removal of very low frequency content may be desired.

2.2.6. NomadLink / Ethernet control and monitoring network

The NomadLink network allows easy setup and control of C Series power amplifiers. The patented network topology allows automatic detection and addressing of multiple amplifiers. Control is via a PC running DeviceControl software, which is connected to the NLB 60E NomadLink Bridge & Network Controller using standard TCP/IP communication. Phantom powering through the standard Cat-5 network cables allows the software to detect devices that are not currently turned on or connected to the mains. This ensures very high reliability and redundancy levels while allowing connected amplifiers to remain on standby with no power consumption.

Cat-5 cable connections can be daisy-chained for easy system setup. There is no need to create a star topology using many switches as with, for example, an Ethernet system. Individual amplifier addresses do not need to be manually entered: you will automatically know where an individual amplifier resides in the network. This reduces total component costs, simplifies installation, and makes daily operation more convenient.

2. Introduction

A daisy chain network loop, in combination with the automatic addressing of devices, enables LAB GRUPPEN's proprietary DeviceControl software to automatically create a precise picture of all connected devices and their relative position in the chain. By quickly creating a clear overview of the entire system configuration, DeviceControl provides flexible control over very large amplifier systems. Setup time is minimized, and critical information is readily available for monitoring performance and avoiding problems during operation.

Via NomadLink, you can monitor all metering data as well as all faults and warning indications simultaneously. NomadLink allows you to remotely power on and power off individual amplifiers or user-definable groups of amplifiers, as well as engage Mute and Solo functions on individual channels.

3. Installation

3.1. Unpacking

Carefully open the shipping carton and check for any noticeable damage. Every LAB GRUPPEN amplifier is tested and inspected before leaving the factory and should arrive in perfect condition. If any damage is discovered, please notify the shipping company immediately. Only the consignee may institute a claim with the carrier for damage incurred during shipping. Save the carton and packing materials for the carrier's inspection. Should you ever need to ship the amplifier, always use the original packaging materials.

3.2. Mounting

The amplifier is two rack units high (2U) and will fit into a standard EIA 19" rack. The depth is 343 mm (13.5"). The weight is approximately 8.5 kg (18.75 lbs.) depending on model type.

Free airflow from front-to-rear of the amplifier must be possible. Therefore, no doors or rack-lids should be mounted in front of or behind the amplifiers.

Amplifiers may be stacked directly on top of each other. There is no need for spacing in between units, though this might enable more convenient installation of cabling on the rear panel.

3.3. Cooling

The amplifier uses a forced-air cooling system with air flow from front to rear, maintaining a low operating temperature within defined limits. Front-to-rear airflow is preferred as cooler air is present at the front in nearly all applications. (This allows higher continuous power levels without encountering thermal problems.) Never attempt to reverse the airflow. The amplifier modules require a pressure chamber between the fans and heat sink, and this effect functions only in one direction.

Make sure that there is an adequate air supply in front of the amplifier, and that the rear of the amplifier has sufficient space to allow the exhaust to escape. If the amplifier is rack-mounted, do not use covers or doors on the front or rear of the rack.

Should a heat sink overheat, the temperature sensing circuits will mute the overheating channel. If the power supply overheats, another sensing circuit will mute all output channels until the power supply cools to safe operating temperature. An early warning before shut down will be indicated on the front panel LEDs, and a warning will be sent through the NomadLink network.

Always make sure that the dust-filters behind the detachable front panel are clean to ensure maximum possible airflow.



NOTE: If the amplifier malfunctions due to dirty dust filters, any required repairs are not covered by the warranty.

To calculate the maximum heat emission value when installing the amplifiers in rooms with an air-conditioning system, please refer to the Current Draw and Thermal Emissions specifications provided in the Appendix (section 6.4).

3.4. Operating Voltage

All C...X amplifiers have a universal power supply that accepts mains voltages from 100-240 V (+/- 10%) @ 50 or 60 Hz. An IEC male receptacle is provided on the rear panel of all amplifiers. The IEC cord included with each amplifier has a male plug appropriate for the power receptacles in the country in which it was sold. If substituting a different IEC mains cord for use in another country, use only a cord that meets or exceeds the power rating of the originally supplied cord.

Once a suitable AC supply is connected, the amplifier can be turned on using the front-panel power switch. The amplifier then goes through a soft-start sequence as it self-checks its circuits. The fans will blow at high speed before dropping to idle, and the "power" LED will illuminate.

Inrush power is controlled and limited during "soft-start", enabling multiple amplifiers to be powered up simultaneously with no danger of overloading the mains power circuit.

 If you are not 100% confident of your competence to replace the mains plug, engage qualified personnel to do the job.

Once a suitable AC supply is connected, the amplifier can be turned on using the front-panel power switch. The amplifier then goes through a soft-start sequence as it self-checks its circuits. The fans will blow at high speed before dropping to idle, and the "power" LED will illuminate.

Inrush power is controlled and limited during "soft start", enabling multiple amplifiers to be powered up simultaneously.

3.5. Grounding

There is no ground lift switch or terminal on the C Series amplifiers. The signal ground is always floating, via a resistor, to chassis and therefore the grounding system is automatic.

In the interests of safety, never disconnect the earth (ground) pin on the AC power cord.

Use balanced input connections to avoid hum and interference.

4. Product Overview

4.1. Front Panel Overview

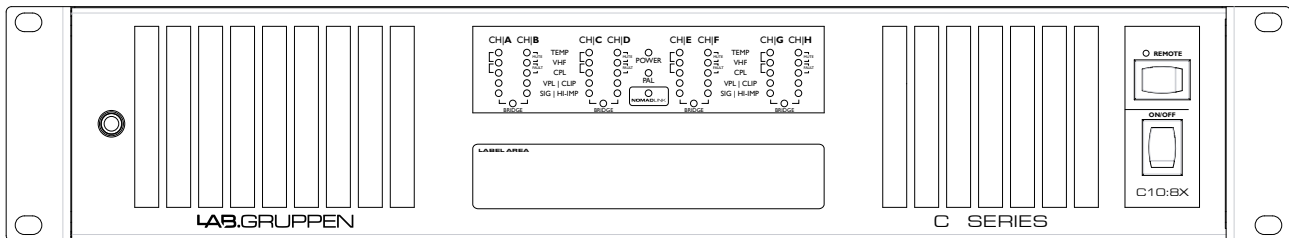

The amplifier's front panel presents the performance and fault condition indicators, power and remote switches, and a removable dust-filter cover. Four level potentiometers located behind the cover provide individual attenuation for the four amplifier channels. Range is 0 dB to - infinity. The 12 o'clock position indicates -10 dB attenuation. A label area is located beneath the LED display.

To remove the dust-filter cover, loosen the thumbscrew at the far left. This allows removal of the dust-filters for cleaning, and provides access to channel attenuation. The front cover may be made "tamper resistant" by replacing the thumbscrew with a Philips head or safety Torx screw. Thread size is M3.



NOTE: Never operate the amplifier without the dust-filters in place.

4.1.1. Power on/off and remote switch

The Power on/off switch is located on the right side. A second switch, labeled "REMOTE," is located above the Power switch. When the Remote switch is on, (with the mains connected and power switch turned on) the yellow LED above it will illuminate indicating that external power on/off commands from the NomadLink network connection will switch the amplifier on or off. When Remote is activated the amplifier will not switch on until a "Power On" command is received from the network. When the remote switch is off, it is not possible to switch amplifier power on or off using NomadLink network control.

4.1.2. Front-panel LED's

The front-panel LED area includes the following indicators per channel:

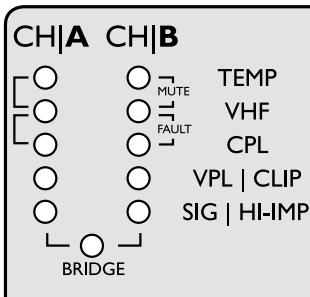

Figure 4.1.2a: Front panel LED display

- **Temperature mute** (Yellow constant)
- **VHF** (Very High Frequency) protection active (output muted) (Yellow)
- **Mute** channel via NomadLink network (2x Yellow)
- **CPL** (Current Peak Limiter) active (Orange flashing)
- **CPL (Orange constant with output muted)**: constant (output muted): Low impedance / short circuit detection
- **Fault** (Yellow plus Orange)
- **VPL** (Voltage Peak Limiter) active, VPL/Clip (Red)
- **-40 dB** signal present (Green)
- **Hi-Imp** open load detected (Red)
- **Bridge mode** operation on (Yellow). Ch. A+B, C+D, E+F, G+H bridged.

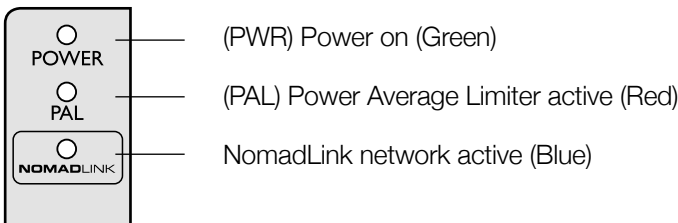

Figure 4.1.2b: Power and PAL LED display



NOTE: When no VPL, CPL or PAL indicators are illuminated, and the VPL DIP-switch is set to maximum at the specified nominal load, the amplifier channel is able to deliver maximum rated output power.



NOTE: When the network is connected, the blue NomadLink LED will illuminate even when mains power is not connected. NomadLink receives phantom power from the network supplied by the NLB 60E.

4.2. Rear panel

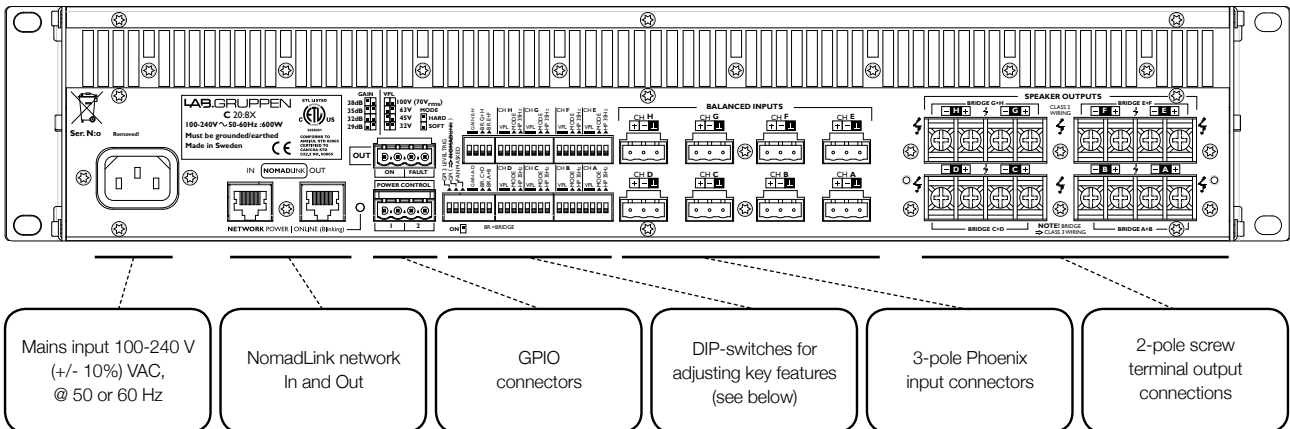

Figure 4.2: C Series rear panel layout

4.2.1. The DIP-switch features

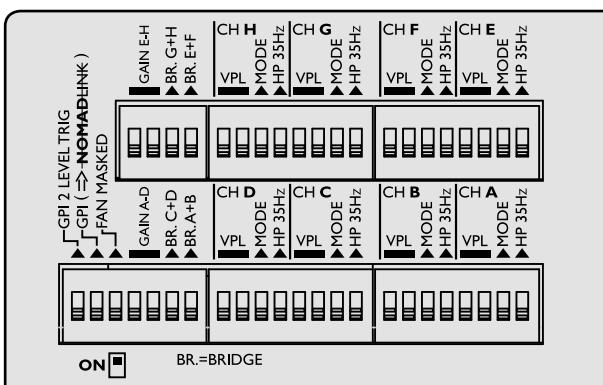

Figure 4.2.1: DIP-switch field on the rear panel

Gain - Set for all four or eight channels from +29 to +38 dB in 3 dB steps.

Fan Masked - When on, engages the intelligent fan feature; fan speed is lowered when no signal is present.

Bridge Mode - Switches the channel pairs into bridge mode operation. An automatic -6 dB gain compensation is applied.



NOTE: When in bridged mode, 2 ohm operation is not recommended.

VPL - Voltage Peak Limiter adjustment is provided for 8 individual levels. Select the setting most appropriate for connected speakers. See Appendix for details.

Mode - Select VPL mode between Hard and Soft. For channels driving sub-woofers and low-end frequencies, it is recommended to use the Hard setting for optimal operation. For mid- and high-frequency drivers, always select Soft.

GPI 2 Level Trig - Disables GPI 1; GPI 2 turns amplifier on when closed, off when open. (See section 5.5).

GPI (- NomadLink) - Disables the amplifier's connectivity to the NomadLink network.

4.3. NomadLink / Ethernet network setup

The amplifier includes, as a standard feature, internal facilities for the NomadLink monitoring and control network. All features of the NomadLink network are accessible via a PC running LAB GRUPPEN's proprietary DeviceControl software. A single rackspace NLB60E NomadLink Bridge & Network Controller, the NLB 60E, accepts the TCP/IP data stream from the computer and converts it to the NomadLink protocols. Even when no computer is connected, the NLB 60E can initiate stand-alone power on/off and muting functions, as well as report any fault or warning condition.

The PC is connected to the NLB 60E using a standard Ethernet interface and a crossed Cat-5 cable (peer-to-peer setup). If a HUB or switch is in the network, standard "straight" Cat-5 cables must be used. The front and rear Ethernet connections on the NLB 60E can be used individually, but only one PC at a time running DeviceControl can access the network.



NOTE: Many newer laptop computers will allow peer-to-peer connection with the NLB 60E using a standard "straight" Cat-5 cable instead of a crossed cable.

The default fixed TCP/IP address of the NLB 60E is 192.168.1.166. The subnet mask is 255.255.255.0. For further system configuration details, please refer to instructions supplied with the NLB 60E unit.

The NomadLink connections between amplifiers use standard "straight" Cat-5/RJ45 equipped cables.



NOTE: US National Differences cl.16.3 requires that NomadLink network cables must be rated VW-1.

The OUT port from the NLB 60E must be connected to the IN port of the first amplifier. The OUT port from the first amplifier in turn connects to the next amplifier's IN port to form a daisy-chain. The OUT port on the last amplifier is connected to the IN port on the NLB 60E to close the loop.



NOTE: There are performance limitations to cable lengths on a NomadLink network, both in terms of total cable length in the loop and between any two devices. These limitations follow standard Ethernet cabling protocols. Read the Operation and Performance chapter in this manual, or the Operation Manual supplied with the NLB 60E, to ensure the network is configured within these constraints.



TIP: Although the network will function as an open loop under most circumstances, it is strongly recommended that the loop be closed by connecting the last amplifier's OUT port to the NLB 60E's IN port. Doing so will improve redundancy and communication speed.



TIP: When using a system that is based entirely on C...X amplifiers, the total number of amplifiers assigned to one NLB 60E subnet should not exceed 30. When a system has a mix of models that include C-, FP+ Series and C...X amplifiers, a total of 60 amplifiers is the recommended maximum.



NOTE: All C...X amplifiers should be counted as two devices in the total count of 60 devices allowed in a mixed-model NLB 60E network.

External contact closures and 24 V low/high triggers can be connected to the GPI connectors on the NLB 60E for control of fire-alarm systems or external power sequencers. For more details read the instructions supplied with the NLB 60E.

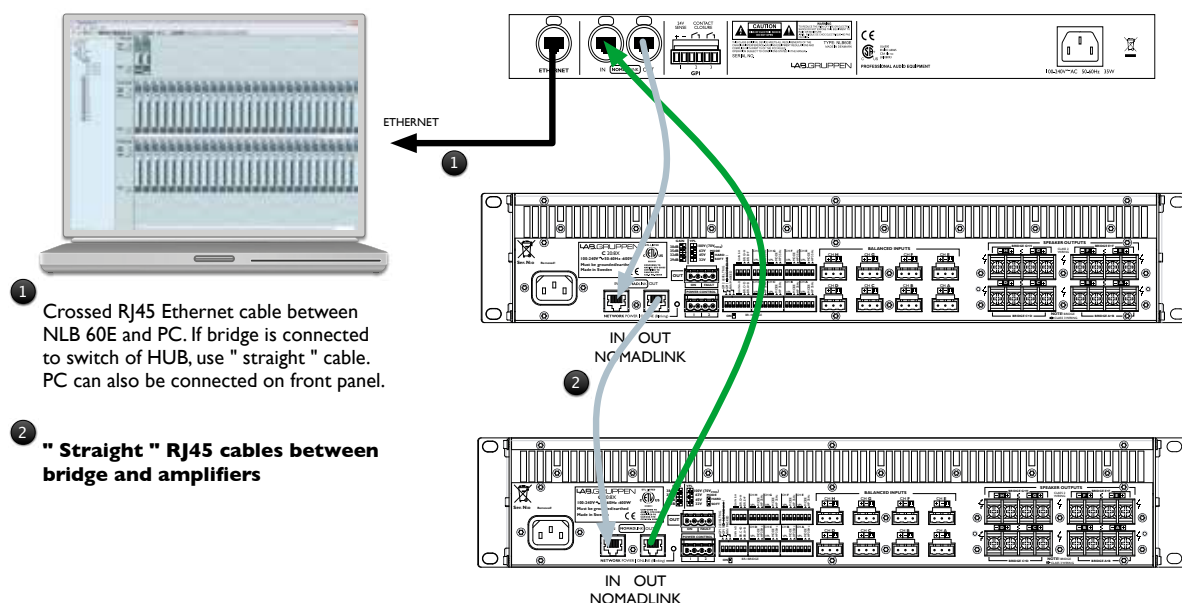

Figure 4.3: Connection details between a PC, the NLB 60E and networked amplifiers

5. Operation and performance

5.1. Introduction

The following sections provide comprehensive information on amplifier connection, setup, operation, and performance. The detailed information included here is essential to realizing the full functionality of the C Series amplifiers.

5.2. Operation precautions

- Make sure that the Power switch and the Remote switch on the amplifier front-panel are set to “off” before making any input, output or network connections, and also before manipulating the DIP-switches on the rear panel.
- This amplifier is equipped with a Universal Power Supply that handles voltages from 100 V to 240 V (+/- 10%) @ 50-60 Hz
- Make sure that no signal is present at the input to the amplifier when powering up. This could produce an unintentionally loud initial volume from the speakers.

5.3. Signal flow and headroom

5.3.1. Signal flow blocks

All C Series amplifiers have the same signal flow and feature set. The only difference is the amplifier's maximum output current per channel.

The input stage of all C Series amplifiers has a high sensitivity to provide ample system headroom. This in effect means that the input stage is almost impossible to clip.

Overall amplifier input gain is adjusted using the input stage DIP-switches. Please note that the gain setting is global, affecting all channels. Following the input stage, the dedicated level control on each channel allows signal attenuation from 0 dB to -infinity.

The CPL (Current Peak Limiter) section dynamically limits the input signal based on three parameters: sensed current level, feedback from the output stage, and sensed voltage clip from the VPL (and output amplifier voltage clip if “Soft Clip” activated). This ensures that power output is maintained within the design limits of the amplifier.

The adjustable VPL (Voltage Peak Limiter) sets the maximum channel output voltage and therefore also the maximum channel output power. Four different voltage stages are available using the DIP-switches on the rear panel.

The sophisticated output section monitors faults and generates appropriate warnings, which are displayed on the amplifier and transmitted through the NomadLink network. These alerts allow the operator to adjust system

settings and thereby avoid problems. In the rare event that conditions are extraordinarily severe, the amplifier will shut down until the fault or problem setting has been rectified or adjusted. These sensing circuits are also feed back voltage and current level information, via a side chain, to the limiters. Sensing circuits also transmit local amplifier module temperature and power supply temperature to the appropriate protection mechanisms. Please refer to the Protection, Faults and Warnings section for further details.

5.3.2. Headroom, sensitivity and VPL / Gain settings

The input amplifier and limiter system is designed to accommodate extremes of performance. Typically, exceeding maximum input by much as +10 dB will only result in a 1% increase in distortion.



NOTE: If you use the level potentiometer in the signal chain to reduce the level by an amount greater than the headroom relative to input sensitivity, AND you drive the amplifier to clip level, you are in danger of clipping the input stage before the current or voltage peak limiters are activated.



NOTE: When bridging two channels, you must add +6 dB to the input sensitivity to achieve maximum output voltage due to the automatic -6 dB gain compensation inserted by the amplifier.

5.4. Audio Input and Output connections

5.4.1. Balanced / Unbalanced Input connection

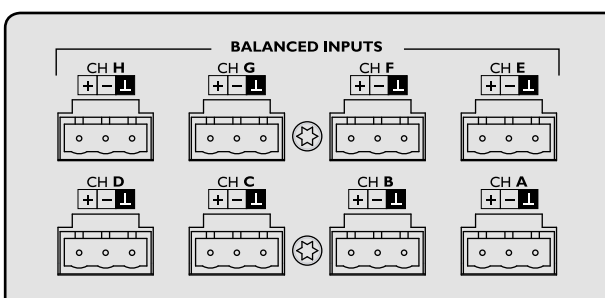

Figure 5.4.1: Phoenix-type input connector field

Electronically balanced, Phoenix-type inputs are provided on all channels. Follow the +, - and Ground labels when connecting the input signal.

5. Operation and performance

If an unbalanced connection is desired this can be achieved by summing the minus (“COLD”) and Ground terminals and using the + terminal as the “HOT” signal. For the best possible performance, the summing of ground and minus wires should be done at the source unit end of the cable (e.g. a CD player).

Four or eight connectors as appropriate are supplied for attaching cables to the inputs. The type of connector used is Phoenix Contacts, Part number MSTB 2,5/3-STZ-5,08



NOTE: When linking the same source signal to several input channels, be aware that there is a limit to the number of channels an output source can “drive”. A typical output source (e.g. a DSP crossover unit) can drive up to four amplifier channels before external line-drivers might be required to buffer the signal.

5.4.2. Output operation and connection

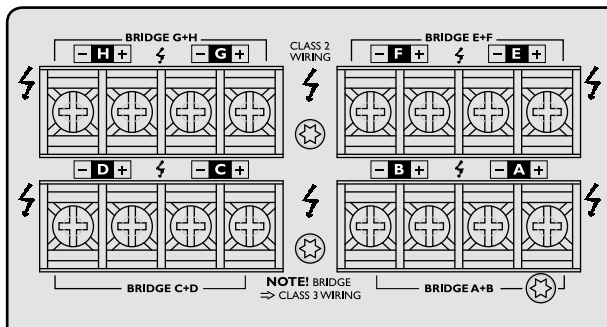



Figure 5.4.2: Screw terminal speaker output field

Screw-terminal connectors with + and – poles are provided at each channel output for connection of the speakers. Make sure that the speaker cables are connected correctly and tightly, and that accurate polarity is maintained to all speakers in the system.

 As the amplifier outputs produce high voltage, do not connect or disconnect speaker cables when the mains power is on. Also, attach the safety cover on the speaker terminals for safe operation and to comply with electrical product approvals.

5.4.3. Output bridge mode

It is possible to bridge channels in adjacent pairs of two (A+B and C+D for example). When bridged, the input source must be connected to input A (A+B) or C (C+D) respectively. Output speaker cables must be connected to the plus pole on channel A.

The main benefit of bridging the output is a doubling of output voltage. Bridging can be used to turn the amplifier into a 3-channel amplifier with, for example, 2 x 250 W and 1 x 500 W at 4 ohms utilizing the C 10:4X, or simply to achieve an impressive 200 V peak supply per channel.

Most power amplifier designs, when bridged, automatically introduce a +6 dB input gain boost which can lead the user to conclude that said amplifier delivers “more than double the power” when in bridge mode. This is clearly not the case, as the gain boost artificially enhances perceived power at the cost of headroom. The C Series amplifiers work on globally set constant gain, and automatically compensate the input gain by -6 dB. For example, if the amplifier is configured in a three channel mode, then the selected gain is maintained from input to output on all channels, discrete or bridged.

5.4.4. Amplifier Input Gain

All C Series amplifiers feature adjustable input gain. This versatility enables the amplifier to accommodate a multitude of system configurations with various input sources and speaker layouts.

Amplifier gain is set globally for all channels on four-channel models, and in four-channel groups (A-D and E-H) on eight-channel models. The range is 29-38 dB in 3 dB increments. Individual channel fine level adjustment is available using the potentiometers on the front panel.

The unique adjustable input gain feature of the C Series makes it easier to attain the optimum balance between headroom and signal-to-noise ratio in the signal path. A weak signal at the input might require the gain to be raised in order to achieve maximum output power with the lowest signal-to-noise ratio. A “hot” input signal, however, would require a lowering of the gain to avoid sending the amplifier into Voltage or Current clipping.

See Appendix for a table containing Gain versus VPL setting implications for input sensitivity and output power. Connect the positive (+) loudspeaker cable to the positive (+) red terminals. Connect the negative (-) loudspeaker cable to the negative (-) black terminals. For bridge mode, connect the positive (+) terminal on Channel A to the positive (+) loudspeaker cable and the negative (-) terminal on Channel B to the negative (-) loudspeaker cable.

5.4.4.1. Channel gain/level (front-panel pots)

Individual channel gain (level) may be adjusted using the potentiometers located on the front-panel behind the dust filter cover. Range is from 0 dB to -infinity in 21 steps. The attenuation is logarithmic, with the 12 o'clock position indicating -10 dB.

Use your fingers or a screwdriver to adjust the potentiometers.



NOTE: If the level control is used to attenuate to a lower level than the headroom relative to input sensitivity AND the amplifier input is driven into clip, there is a danger of clipping the input stage before the current or voltage peak limiters are activated.

5.4.5. Amplifier sensitivity

Sensitivity is defined as how many volts (rms) or dBu (referred to 0.775 Vrms) are required to achieve full (maximum) output power. As the output power varies with the load impedance, 4 ohms is usually the common reference.

Since C Series amplifiers are capable of providing multiple maximum output power levels through use of the VPL feature, many sensitivity calculations may be required for a single amplifier. We recommend use of the DeviceControl software to simplify this process. DeviceControl's Device View page, used in combination with the DIP-switch settings display, will automatically produce a sensitivity calculation from the given data (VPL, Gain and load).

5.4.6. Output Voltage Peak Limiter (VPL)

The Voltage Peak Limiter (VPL) is a unique feature in C Series amplifiers. It is used to select the maximum power available on each output channel. Four levels can be set using the DIP-switches on the amplifier's rear panel.

V peak	Vrms
100	70.7
63	44.5
45	31.8
32	22.6

Figure 5.4.6: VPL values in both V peak and Vrms

The values for VPL are displayed as maximum Voltage Peak. To translate Voltage Peak into Vrms, you must divide the Voltage Peak values by 1.41 (see table 5.4.6).

The VPL allows you to set the correct maximum output peak power for optimum performance with the connected speakers. The correct setting depends on the system type (low or high impedance) and the specific load connected to the channel. Since each channel can be configured to deliver either very high voltage peak power OR high current draw at low impedances, it is important to set the VPL correctly.

To configure an individual output channel for a constant voltage system, you simply adjust the DIP-switches to the desired voltage. However, when using an output for a low-impedance system (4, 8 or 16 ohms), then you may need to adjust the VPL to a lower setting to avoid either delivering excessively high continuous power to the speaker or overheating of the output channel through high current draw. For example, with a very "hot" continuous output signal, the temperature could rise to a critical level and activate Temp warning or even Temp Mute. Lowering the VPL setting usually will solve this situation.

If the Current Peak Limiter is active or indicates low impedance, lowering the VPL setting can rectify this situation as well.

5.4.7. Constant voltage 70 V and 100 V systems setup and operation

When using C Series amplifiers to drive constant voltage (high-impedance) speaker systems at 70 Vrms or 100 V peak, you can in most cases simply connect the speakers to the amplifier output terminals, select the correct VPL setting, and place the amplifier in service.

5.4.8. Output Current Peak Limiter (CPL)

The Current Peak Limiter (CPL) ensures that the amplifier will not be damaged by trying to deliver current to the outputs exceeding the physical limitations of the transistors. The CPL keeps the amplifier within the Safe Operating Area. The CPL is non-adjustable and has different limit values depending on model type. The maximum output current values for the four C...X models are:

- C 20:8X, 8 Arms per channel
- C 10:8X, 5.6 Arms per channel
- C 10:4X, 8 Arms per channel
- C 5:4X, 5.6 Arms per channel

CPL activity is indicated by illumination of an orange LED for each channel on the front-panel. Warnings also are shown in the DeviceControl software's GUI.

A steadily illuminated orange CPL LED indicates a short circuit situation (or very low impedance). The output will mute for 6 seconds before measuring the output impedance again. This will continue until the short circuit is fixed, at which time the output will automatically un-mute. An input signal must be present to allow detection of short circuit or low impedance conditions.



TIP: If the CPL LED is steadily illuminated orange while the output is muted and the -4 dB signal LED is NOT on, then the amplifier output is detecting a short circuit or low impedance condition. The problem can be solved by checking input and output cables and examining the state of the loudspeaker load. If there is no short circuit present, then the condition may be rectified by lowering the VPL or input levels.

If the CPL indicator is lit continuously, then the amplifier is delivering excessive current and is being forced into a current limiting state (output muted).

5.5. GPIO connection and operation

5.5.1. Introduction

C...X amplifiers provide extensive GPIO (General Purpose Input / Output) facilities to enable interfacing with third-party systems for AV control and power sequencing. GPIO functions are accessed through two-pole Phoenix connectors and DIP-switches on the rear panel.

5.5.2. General Purpose Outputs (GPO)

Two GPOs are provided, with connectors labeled ON (GPO 1) and FAULT (GPO 2). Both operate using internal relays which respond to external contact closures.

The GPO 1 (ON) is open when the amplifier power is off. The GPO 1 relay closes when the amplifier power is turned on, either from the front panel or remotely using NomadLink or the GPI (General Purpose Input).

The GPO 2 (FAULT) relay is open when the amplifier is operating normally. The relay closes when the amplifier reports any Fault condition, such as VHF, DC or TEMP.

5.5.3. General Purpose Inputs (GPI)

The GPI functions are enabled only when the front panel Power and Remote switches are both in the ON position. GPI functions respond to closure of the two associated GPI pins. Two modes of remote power control are provided, depending on the position of the DIP-switch "GPI 2 LEVEL TRIG."

When the GPI 2 LEVEL TRIG DIP-switch is set to OFF:

POWER CONTROL 1 toggles the amplifier's power state (ON or OFF) when the connection goes from Open to Closed and remains closed for a minimum of approximately 0.2 second. The power state does NOT change if the connection opens. (This prevents any unintended change in power state should the connection be opened by a DC signal circuit fault.)

POWER CONTROL 2 also toggles the amplifier's power state (ON or OFF) every time the connection goes from Open to Closed and remains closed for a minimum of approximately 0.2 second.

This mode provides redundancy, and also accommodates systems with separate closure circuits for ON and OFF functions.

When GPI 2 LEVEL TRIG DIP-switch is set to ON:

POWER CONTROL 1 connection is disabled. The amplifier ignores any change of state on this port.

POWER CONTROL 2 will follow the state of the port. If the connection is closed, the amplifier turns on; if the connection is open the amplifier will turn off.



NOTE: The following additional technical information describes GPI port functionality:
 Maximum “open” contact voltage: 5 V
 Maximum “closed” contact current: 1 mA
 Maximum resistance for “closed” contact: 1 kOhm

5.5.4. NomadLink disable switch

The DIP-switch labeled “GPI (- NomadLink)” completely disables the amplifier’s connectivity to the NomadLink network.

5.6. Protection, faults and warnings

5.6.1. Introduction

C Series amplifiers incorporate a sophisticated and comprehensive set of protection features. Faults and warnings are indicated on the front-panel and reported via the NomadLink network for indication on the DeviceControl GUI.

5.6.2. Very High Frequency protection

All C Series amplifiers include protection circuits that detect continuous Very High Frequency (VHF) content in the input signals. The detection begins at approximately 10 kHz and moves upwards to include ultrasonic signals. If VHF signals are detected, the output will mute for six seconds before re-measuring. Once no continuing VHF signal is detected, the output un-mutes and returns to normal operation.

This feature recognizes that continuous full-scale VHF signals do not appear in “natural” sources such as music. Any such signals can therefore be considered as a fault when present. VHF protection is essential in avoiding damage to high frequency drivers.

The VHF protection operational area is dependent on output power level and frequency. The illustration below shows a decreasing threshold on the output power level, starting at approximately 10 kHz and rising with a -6 dB slope. This defines the VHF protection area. When continuous output power above the threshold line is detected the VHF protection becomes active.

The Attack time for the VHF protection is increasingly shorter at higher frequencies. For example, an ultrasonic continuous signal will cause the outputs to mute rapidly, where it will take several milliseconds for a 10 kHz continuous signal to trigger the output mute.

The VHF protection is NOT a limiter and does not alter the amplifier’s frequency response. It is implemented solely to detect continuous VHF content. The amplifier will always pass VHF peaks at full power, with no effect on musical “transients”.

5. Operation and performance

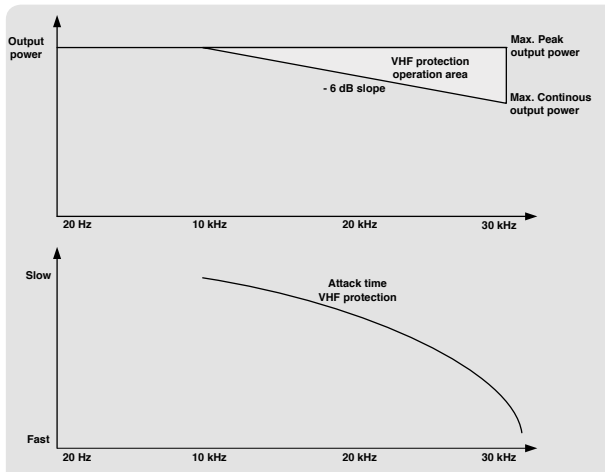

Figure 5.6.2: VHF protection operational area

The VHF protection is indicated by a yellow LED on the amplifier front panel, with output muting for six seconds when active. It is reported as a fault via the NomadLink network on the DeviceControl GUI.

5.6.3. DC protection

DC protection is implemented on each output to prevent damage to connected loudspeakers. DC present at the output will trigger muting and illuminate the fault LED indicator. Any DC present at the output indicates a hardware malfunction that requires servicing of the amplifier.

5.6.4. High-impedance warning (open load)

A high-impedance (open load) condition is indicated when an input signal above approximately -29 dB is detected and no functioning loudspeakers are connected to the amplifier. The fault is indicated by a red Sig/Hi-imp LED. The indicator is green when a valid load is present under the same input signal conditions.



NOTE: Since the high-impedance detection initially triggers only when the input signal rises above -29 dB, it might cause the indicator to first turn green, and then orange, even in situations where no speaker is connected.

5.6.5. Low-impedance protection (short circuit)

A low-impedance or short circuit fault is detected when current draw is high (Current Peak Limiter active) and when, simultaneously, output signal is low. When this occurs, the amplifier protects the output stage from damage by muting the output signal and bypassing the circuits. Indication of this fault is a constant orange illumination of the Current Peak Limiter (CPL) LED on the front panel. The protection will sequence at six second intervals to re-measure conditions. If the low-impedance fault is no longer detected, the amplifier will un-mute.



NOTE: If the CPL turns constant orange, the output is muted, and the -4dB signal LED is ON, then the amplifier has gone into maximum current protection. This situation is caused by an excessive input signal and is not due to a short circuit. Turn down the input signal to avoid or remedy this situation.

5.6.6. Temperature protection

Thermal output points are shared by each channel pair. These indicators will, if the pre-specified temperature level is exceeded, give a high temperature warning. This warning condition is indicated by a flashing Temp LED on the front-panel, and it is reported on the Device Control GUI via the NomadLink network.

As the amplifier approaches a thermal protection threshold, the warning LED sequence will start with short “on-time” bursts. If the amplifier continues to overheat and approaches the temperature limit, the flashing sequence will be defined by longer and longer on-time bursts until the protection mode is activated.

If the temperature becomes too high to continue safe operation, the overheated output channel(s) will be muted until the temperature returns to an acceptable level.

Fully active temperature protection (with muting) is indicated by a constantly illuminated Temp LED. It will also be indicated as a fault via the NomadLink network on the DeviceControl GUI.

Temperature measurements will continue at six second intervals. The output will un-mute when the channel or power supply returns to a safe operating temperature.

5.6.7. Power Average Limiter (PAL)

The Power Average Limiter (PAL) controls the current-drawing relationship between the power supply and the mains inlet. PAL limits the maximum average power consumption according to the power supply capabilities, ensuring that the PSU will not overload by limiting the amplifier’s maximum current draw.

Soft-start

High powered amplifiers with inadequate inrush limiting can pull considerable current from the mains at turn-on. This can result in unexpected tripping of fast-acting mains breakers. Such is not the case with C Series amplifiers. The C Series amplifiers have very low inrush power as the capacitors are charged slowly and in a controlled manner ensuring that breakers will not trip.

Several amplifiers will, under normal conditions, be able to be powered up simultaneously. If you do experience problems powering up multiple amplifiers simultaneously, use the NomadLink network and the NLB 60E to establish a power sequence with a pre- set delay between each amplifier’s start-up.

5.6.8. Level indicators

Each channel pair of the C...X amplifier has an indicator window with five LEDs per channel plus a bridge indicator.

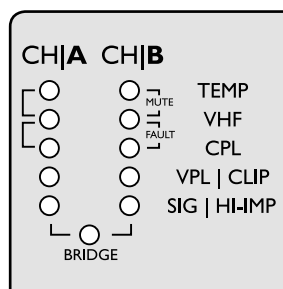

Figure 5.6.8: Front panel LED indicators

- Orange CPL (Current Peak Limiter) flashing indicates signal exceeds the limits of the output devices and limiting is in effect.
- Red VPL/CLIP indicates that the signal has exceeded maximum output voltage (Maximum voltage is determined by rear-panel VPL settings).
- Signal / Hi-Imp (Green/Red) indicates an output signal above -44 dB. If it turns Red, this indicates that a high impedance (“open” connection) has been detected at the output. This can be a fault such as a disconnected cable or malfunctioning driver. However, it could indicate acceptable high impedance, such as a sub-bass enclosure with high impedance at a certain frequency.

For more detailed signal level indications use the DeviceControl software application.

5.6.9. Level adjust

Level adjust potentiometers (one per channel) are located behind the removable dust-filter cover on the amplifier’s front-panel. It is not possible to adjust the level settings with the cover in place.

Step	Attenuation	Step	Attenuation
1 (Min)	-Inf. dB	12	-8.7 dB
2	-Inf. dB	13	-7.4 dB
3	-50 dB	14	-6.0 dB
4	-40 dB	15	-4.5 dB
5	-35 dB	16	-2.7 dB
6	-21.5 dB	17	-0.6 dB
7	-21.5 dB	18	-0.3 dB
8	-14.7 dB	19	-0.1 dB
9	-12.9 dB	20	0 dB
10	-11.4 dB	21 (Max)	0 dB
11	-10.0 dB		

The potentiometer's operational range is 0 dB to -infinity in 31 steps. Attenuation is logarithmic, with 12 o'clock position being -10 dB. See table to the above with increments.

It is not possible to adjust the individual channel attenuation from the NomadLink network or elsewhere on the amplifier.

Use fingers or a screwdriver to adjust the potentiometers.

5.6.10. Mute indication

Individual channel Mute is indicated by illumination of the two yellow LEDs at the top of the channel's LED bargraph. If both LEDs are illuminated and all other indications are normal, then the channel has been muted by a command from the NLB 60E front panel or the DeviceControl application. Otherwise, a Mute could indicate a fault condition. (See below.)

5.6.11. Performance, Warning and Fault indicators

- Power on/off (green) indicates that mains power is switched on.
- NomadLink (blue) indicates that the network is connected. The NomadLink LED will light up even before the mains power is connected and switched on as it takes phantom power from the NomadLink network cable.
- Bridge mode (yellow) indicates if two channels are bridged using the DIP-switch on the rear panel.
- CPL, Current Peak Limiter (orange), when flashing indicates the maximum possible current draw has been reached.
- CPL, Current Peak Limiter (orange), when constant indicates excessive current draw caused by a short circuit on the output or very low operational impedance. When detected, the output will mute for six seconds before re-measuring the output impedance. This will continue until the short circuit is removed. CPL remains constant orange in a fault condition only when an input signal is present.
- Temperature (yellow) warning is indicated by a flashing LED. If the amplifier goes into thermal protect (output muted) the LED illuminates constant yellow.
- VHF, Very High Frequency protection (yellow), indicates that potentially harmful continuous high frequencies have been detected on the input signal. The output is muted.
- PAL, Power Average Limiter (red), indicates that the amplifier is limiting because the power supply and/or the mains-inlet fuse has reached maximum capability.
- Hardware fault is indicated when both the CPL and VHF indicators light up simultaneously. The amplifier requires servicing before being placed back in operation.

5.7. NomadLink network and DeviceControl software

5.7.1. NomadLink network in the amplifiers

All C Series amplifiers are equipped with the proprietary NomadLink network interface. This includes two RJ45 connections in standard housings: one IN and one OUT.

Use standard straight Cat-5 Ethernet cables with RJ45 connectors to connect the amplifier to the NLB 60E NomadLink Bridge and Network Controller or to daisy-chain multiple amplifiers.



NOTE: It is very important that two IN or two OUT ports are NEVER connected to each other. This will cause the NomadLink communication and DeviceControl to exhibit erratic behavior and display inaccurate data. However, this situation will not damage the amplifier circuitry.

Up to 60 amplifiers can be connected to one NLB 60E in a daisy-chain or closed loop. In systems that consist of C...X Series as well as standard C Series or FP+ amplifiers, each C...X unit should be counted as two devices on the network, with the total device count not to exceed 60 devices per subnet.



NOTE: Each networked group of amplifiers being controlled by an individual NLB 60E is referred to as a Subnet.

When the NLB 60E is powered up, the NomadLink network receives phantom power. This causes the blue NomadLink LED on the amplifier front panel and the NomadLink LED on the rear panel to light up. Because the entire network receives phantom powering from the NLB 60E, NomadLink is active even when the amplifier has mains power disconnected or is not yet powered up. Should an amplifier fail or be inadvertently disconnected from the mains, network integrity is fully maintained and all amplifiers remain visible on the system.

5.7.2. Connection and setup

The NomadLink network requires use of an NLB 60E. The NomadLink network is established by connecting the NLB 60E OUT port to the first amplifier's IN port. Then a daisy-chain is established by connecting the first amplifier's OUT port to the next amplifier's IN port, and so on. If a closed loop network is desired for improved redundancy (highly recommended), the last amplifier's OUT port must be connected to the NLB 60E's IN port.

For all connections, straight Cat-5 RJ45-equipped Ethernet cables should be used.

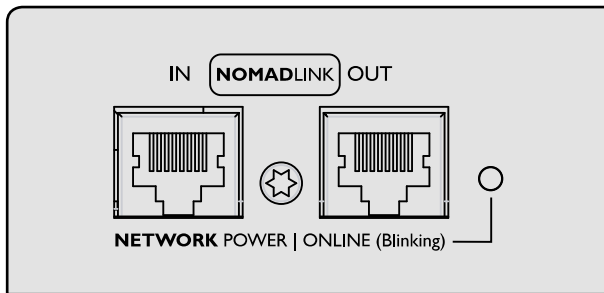

Figure 5.7.2a: Rear panel NomadLink connections

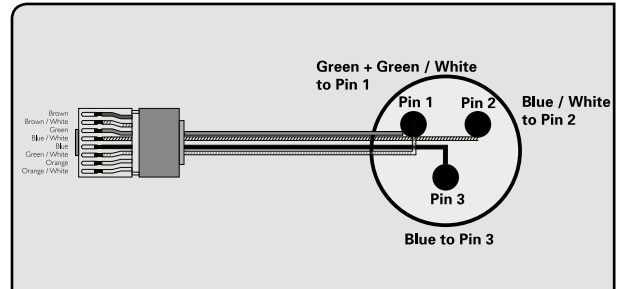

Figure 5.7.2b: XLR to RJ45 connections

**TIP**

TIP: Optimal NomadLink performance can only be assured when using Cat-5 cables. However, as NomadLink is only using two wires + ground for communication and phantom power it is possible to create converters from RJ45 to, for example, XLR connectors using 2-wire shielded cable. The NomadLink network can then be operated using a standard tie-line in a multicore signal distribution system. See the drawing below for an example of how to create a converter.



NOTE: If any cable format or connection other than Cat-5 (or better) and RJ45 is utilized, network performance may be compromised. In this event LAB GRUPPEN cannot guarantee that the NomadLink network will be fully operational.

5.7.3. NomadLink network cable lengths

The connection between the NLB 60E and your PC is a standard Ethernet network running the TCP/IP protocol. Cable distances between NLB 60E and your PC follow standard rules for Ethernet systems.

In situations where the amplifiers and the NLB 60E will be positioned in different locations at some distance from each other, or where groups of amplifiers within a single subnet with up to 60 units will be installed with a distance in between, these general rules applying to Ethernet cabling limitations may be considered.

- Rule 1: The maximum cable length in between any two devices may not exceed 300 meters / 980 feet.
- Rule 2: In a non-closed-loop daisy-chained subnet the total maximum cable length is 400 meters / 1300 feet.
- Rule 3: In a closed-loop subnet the total maximum cable length is 700 meters / 2300 feet.

5.7.4. Ethernet network cable lengths

The connection between the NLB 60E and your PC is a standard Ethernet network running the TCP/IP protocol. Cable distances between NLB 60E and your PC follow standard rules for Ethernet systems.

Contact your an IT expert or an authoritative source for more details. Below are typical examples of NomadLink network setups:

Figure 5.7.4 shows typical examples of NomadLink network setups:

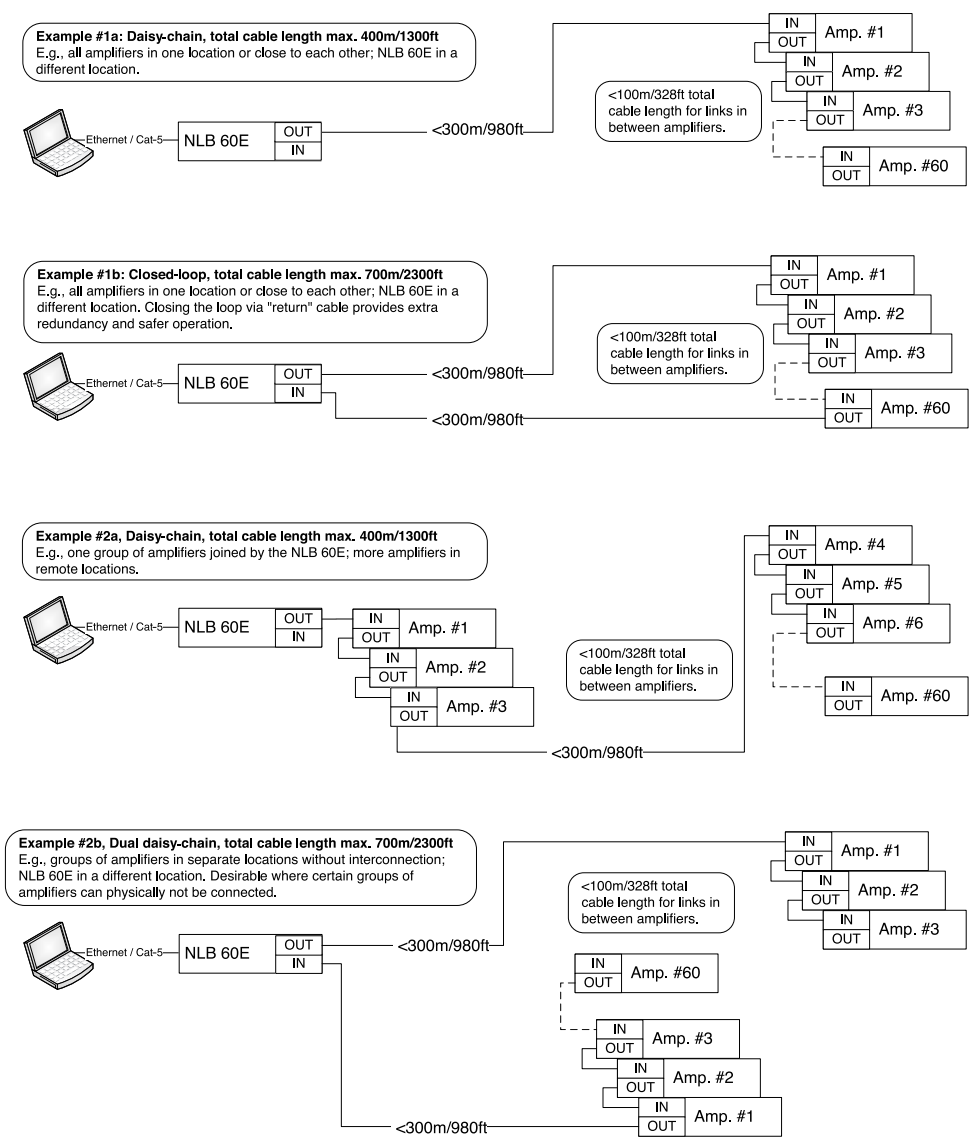

Table 5.7.4: Typical NomadLink network configurations

5.7.5. DeviceControl software

DeviceControl is LAB GRUPPEN's proprietary software application for monitoring and controlling networked C Series (as well as FP+ Series) power amplifiers. DeviceControl runs on a Windows PC, which connects via Ethernet to the NLB 60E. DeviceControl provides comprehensive monitoring of amplifier status as well as control of amplifier power on/off and individual channel mute and solo functions. Please review the DeviceControl Operation Manual for more detailed information.



NOTE: The current versions of DeviceControl software and the DeviceControl Operation Manual are available for download on our web site: www.labgruppen.com

5.7.6. Third Party Control and Monitoring Capabilities

The NLB 60E NomadLink Bridge & Network Controller can be integrated with third party control systems via its Ethernet connection. All amplifier control functions, fault and warning notifications that would otherwise be displayed via the DeviceControl software can be replicated in a third party control GUI.

Please note that NLB 60E Firmware Ver 2.1.0 (or later) must be used in order to utilize the third party control and monitoring capabilities of the NomadLink network. Both the firmware package and the control protocol documentation, which describes the functionality and programming requirements for third party integration, can be found under the Software & Firmware section of our website at:

http://labgruppen.com/index.php/support/software_firmware/

6. Appendix

6.1. Maintenance

During normal operation your C Series amplifier will provide trouble-free service. The only user maintenance required is to periodically vacuum clean the foam dust filters behind the front grille.

In some extreme cases it may be necessary for authorized service personnel to clean the inside of the amplifier in order to safely remove dust or other build-ups which may occur during prolonged normal usage. If you are using your amplifier in a heavy-duty application, it is recommended to have your amplifier serviced every three years purely as a preventative action.

6.2. FAQ

Following are common questions asked about LAB GRUPPEN C Series power amplifiers together with helpful answers.

Q: What is the input sensitivity of the amplifiers?

A: Input sensitivity is calculated from the amplifier gain, maximum output voltage and load. As gain and output voltage are adjustable in C Series amplifiers, you need to look this information up in a table found in the Appendix section of this manual. Input sensitivity also is automatically calculated in the DeviceControl software application.

Q: What are the maximum cable lengths allowed when using the NomadLink network?

A: NomadLink uses a daisy-chain topology to connect amplifiers and an NLB 60E in a network. Standard RJ45-equipped Cat-5 cables are used throughout. The daisy chain may be made into a closed-loop by connecting a return cable to the NLB 60E from the last amplifier.

General rules of cable lengths:

- The maximum cable length in between any two devices may not exceed 300 meters / 980 feet.
- In a non-closed-loop daisy-chained subnet the maximum cable length is 400 meters / 1300 feet.
- In a closed-loop subnet the maximum cable length is 700 meters / 2300 feet.

Exceeding these limits may result in lost contact with the devices, or loss of phantom powering due to cable resistance.

Q: How long can cable-runs be on the Ethernet network connecting the NLB 60E to the PC?

A: On the Ethernet side, normal Ethernet cable limits apply. This is typically a maximum of 80 meters / 300 feet between each device. Follow standard installation procedures for Ethernet. Distances beyond 100 meters may require use of a repeater, a format converter, or optical cables.

Q: Why is the NomadLink network a closed-loop topology?

A: Technically speaking, the closed loop is optional. The purpose of closing the loop is primarily to provide a secondary path to the amplifiers. If cables are broken or disconnected in either direction, all amplifiers still may be addressed by the network.

Q: How can I be sure that no protection circuits or safety functions interfere with the output signal?

A: If no Clip or Warning LEDs on the front panel light up, you can be fully confident that the rated maximum output power in the full frequency range is available for your speakers. No limiting or gain-reduction takes place without a warning or fault indication.

6.3. Additional documentation

In case you didn't find what you were looking for in this Operation Manual, check out the website at www.labgruppen.com, where you can find a multitude of additional documentation for C Series.

6.4. Current Draw and Thermal Dissipation Specifications

The following tables contain information on measured current consumption as well as calculated heat dissipation during normal operation (1/8 rated power); and during extreme heavy duty operation (1/4 rated power).

C 20:8X										
Level	Load	Rated power		Line Current *2)		Watt *1)			Thermal Dissipation	
				120 VAC	230 VAC	In	Out	Dissipated	BTU/hr	kCal/hr
Standby w. remote Power Off via NomadLink						6	0	6	20	5
Power On, Idling						91	0	91	312	79
				Amp		Watt				
Pink noise (1/8)	70 V / Ch.	250	x8	4,8	2,5	546	250	296	1011	255
	16 Ω / Ch.	250	x8	4,2	2,2	486	250	236	807	203
	32 Ω / Bridged	500	x4							
	100 V / Ch.	500	x4	3,6	1,9	418	250	168	573	144
	8 Ω / Ch.	250	x8	3,5	1,8	399	250	149	509	128
	16 Ω / Bridged	500	x4							
	4 Ω / Ch.	250	x8	3,4	1,8	376	250	126	431	109
	8 Ω / Bridged	500	x4							
	2 Ω / Ch.	125	x8	2,3	1,2	259	125	134	459	116
	4 Ω / Bridged	250	x4							
Pink noise (1/4)	70 V / Ch.	250	x8	7,4	3,9	785	500	285	972	245
	16 Ω / Ch.	250	x8	7,3	3,8	782	500	282	961	242
	32 Ω / Bridged	500	x4							
	100 V / Ch.	500	x4	6,7	3,5	774	500	274	937	236
	8 Ω / Ch.	250	x8	6,7	3,5	772	500	272	928	234
	16 Ω / Bridged	500	x4							
	4 Ω / Ch.	250	x8	6,5	3,4	743	500	243	830	209
	8 Ω / Bridged	500	x4							
	2 Ω / Ch.	125	x8	3,8	2,0	435	250	185	632	159
	4 Ω / Bridged	250	x4							
*1) The amplifier's PSU operates as a non-resistive load, so the calculation "Volts x Amps = Watts" would not be correct. Instead, measured and specified here is what is known as the "Active Power" in the amplifier providing useful, real-world values of power consumption and heat dissipation.										
*2) Current draw figures measured at 230 V. 115 V figures are 230 V figures multiplied by two.										

C 10:8X										
Level	Load	Rated power		Line Current *2)		Watt *1)			Thermal Dissipation	
				120 VAC	230 VAC	In	Out	Dissipated	BTU/hr	kCal/hr
Standby w. remote Power Off via NomadLink						6	0	6	20	5
Power On, Idling						91	0	91	312	79
Pink noise (1/8)	70 V / Ch.	125	x8	Amp		Watt				
	16 Ω / Ch.	125	x8	3,2	1,7	338	125	213	726	183
	32 Ω / Bridged	250	x4	2,8	1,5	291	125	166	566	143
	100 V / Ch.	250	x4	2,7	1,4	281	125	156	532	134
	8 Ω / Ch.	125	x8	2,5	1,3	254	125	129	439	111
	16 Ω / Bridged	250	x4							
	4 Ω / Ch.	125	x8	2,4	1,3	245	125	120	408	103
	8 Ω / Bridged	250	x4							
	2 Ω / Ch.	63	x8	1,6	0,9	167	63	104	354	89
4 Ω / Bridged	126	x4								
Pink noise (1/4)	70 V / Ch.	125	x8	5,6	2,9	625	250	375	1280	322
	16 Ω / Ch.	125	x8	4,5	2,3	507	250	257	877	221
	32 Ω / Bridged	250	x4							
	100 V / Ch.	250	x4	4,3	2,2	484	250	234	800	201
	8 Ω / Ch.	125	x8	3,5	1,8	390	250	140	478	120
	16 Ω / Bridged	250	x4							
	4 Ω / Ch.	125	x8	3,7	1,9	411	250	161	548	138
	8 Ω / Bridged	250	x4							
	2 Ω / Ch.	63	x8	2,4	1,2	257	126	131	447	113
4 Ω / Bridged	126	x4								
*1) The amplifier's PSU operates as a non-resistive load, so the calculation "Volts x Amps = Watts" would not be correct. Instead, measured and specified here is what is known as the "Active Power" in the amplifier providing useful, real-world values of power consumption and heat dissipation.										
*2) Current draw figures measured at 230 V. 115 V figures are 230 V figures multiplied by two.										

C 10:4X										
Level	Load	Rated power		Line Current *2)		Watt *1)			Thermal Dissipation	
				120 VAC	230 VAC	In	Out	Dissipated	BTU/hr	kCal/hr
Standby w. remote Power Off via NomadLink						6	0	6	20	5
Power On, Idling						51	0	51	312	79
				Amp		Watt				
Pink noise (1/8)	70 V / Ch.	250	x4	2,7	1,4	274	125	149	509	128
	16 Ω / Ch.	250	x4	2,5	1,3	252	125	127	432	109
	32 Ω / Bridged	500	x2							
	100 V / Ch.	250	x4	2,0	1,0	225	125	100	341	86
		500	x2							
	8 Ω / Ch.	500	x2	2,1	1,1	217	125	92	314	79
	16 Ω / Bridged									
	4 Ω / Ch.	250	x4	2,3	1,2	230	125	105	359	90
	8 Ω / Bridged	500	x2							
2 Ω / Ch.	125	x4	1,3	0,7	136	63	73	249	63	
4 Ω / Bridged	250	x2								
Pink noise (1/4)	70 V / Ch.	250	x4	4,9	2,6	526	250	276	942	237
	16 Ω / Ch.	250	x4	4,3	2,2	458	250	208	710	179
	32 Ω / Bridged	500	x2							
	100 V / Ch.	500	x2	3,3	1,7	384	250	134	456	115
	8 Ω / Ch.	250	x4	3,5	1,8	364	250	114	388	98
	16 Ω / Bridged	500	x2							
	4 Ω / Ch.	250	x4	3,6	1,9	373	250	123	421	106
	8 Ω / Bridged	500	x2							
	2 Ω / Ch.	125	x4	2,2	1,1	219	125	94	321	81
4 Ω / Bridged	250	x2								
*1) The amplifier's PSU operates as a non-resistive load, so the calculation "Volts x Amps = Watts" would not be correct. Instead, measured and specified here is what is known as the "Active Power" in the amplifier providing useful, real-world values of power consumption and heat dissipation.										
*2) Current draw figures measured at 230 V. 115 V figures are 230 V figures multiplied by two.										

C5:4X										
Level	Load	Rated power		Line Current *2)		Watt *1)			Thermal Dissipation	
				120 VAC	230 VAC	In	Out	Dissipated	BTU/hr	kCal/hr
Standby w. remote Power Off via NomadLink						6	0	6	20	5
Power On, Idling						51	0	51	312	79
Pink noise (1/8)	70 V / Ch.	125	x4	Amp		Watt				
	16 Ω / Ch.	125	x4	1,7	0,9	176	63	114	387	98
	32 Ω / Bridged	250	x2	1,5	0,8	156	63	94	319	80
	100 V / Ch.	250	x2	1,4	0,7	152	63	89	305	77
	8 Ω / Ch.	125	x4	1,3	0,7	134	63	72	244	62
	16 Ω / Bridged	250	x2	1,3	0,7	131	63	68	233	59
	4 Ω / Ch.	125	x4	0,9	0,5	94	32	62	213	54
	8 Ω / Bridged	250	x2							
	2 Ω / Ch.	63	x4							
4 Ω / Bridged	126	x2								
Pink noise (1/4)	70 V / Ch.	125	x4	3,0	1,6	330	125	205	700	176
	16 Ω / Ch.	125	x4	2,4	1,3	265	125	140	476	120
	32 Ω / Bridged	250	x2	2,3	1,2	252	125	127	433	109
	100 V / Ch.	250	x2	2,0	1,1	222	125	97	331	83
	8 Ω / Ch.	125	x4	2,1	1,1	228	125	103	350	88
	16 Ω / Bridged	250	x2	1,3	0,7	139	63	76	260	65
	4 Ω / Ch.	125	x4							
	8 Ω / Bridged	250	x2							
	2 Ω / Ch.	63	x4							
4 Ω / Bridged	126	x2								
*1) The amplifier's PSU operates as a non-resistive load, so the calculation "Volts x Amps = Watts" would not be correct. Instead, measured and specified here is what is known as the "Active Power" in the amplifier providing useful, real-world values of power consumption and heat dissipation.										
*2) Current draw figures measured at 230 V. 115 V figures are 230 V figures multiplied by two.										

6.5. Signal flow and VPL to output measurements

The table below shows the block signal flow of the C...X Series amplifiers, as well as a table providing output power based on the settings of the rear panel VPL DIP-switches.

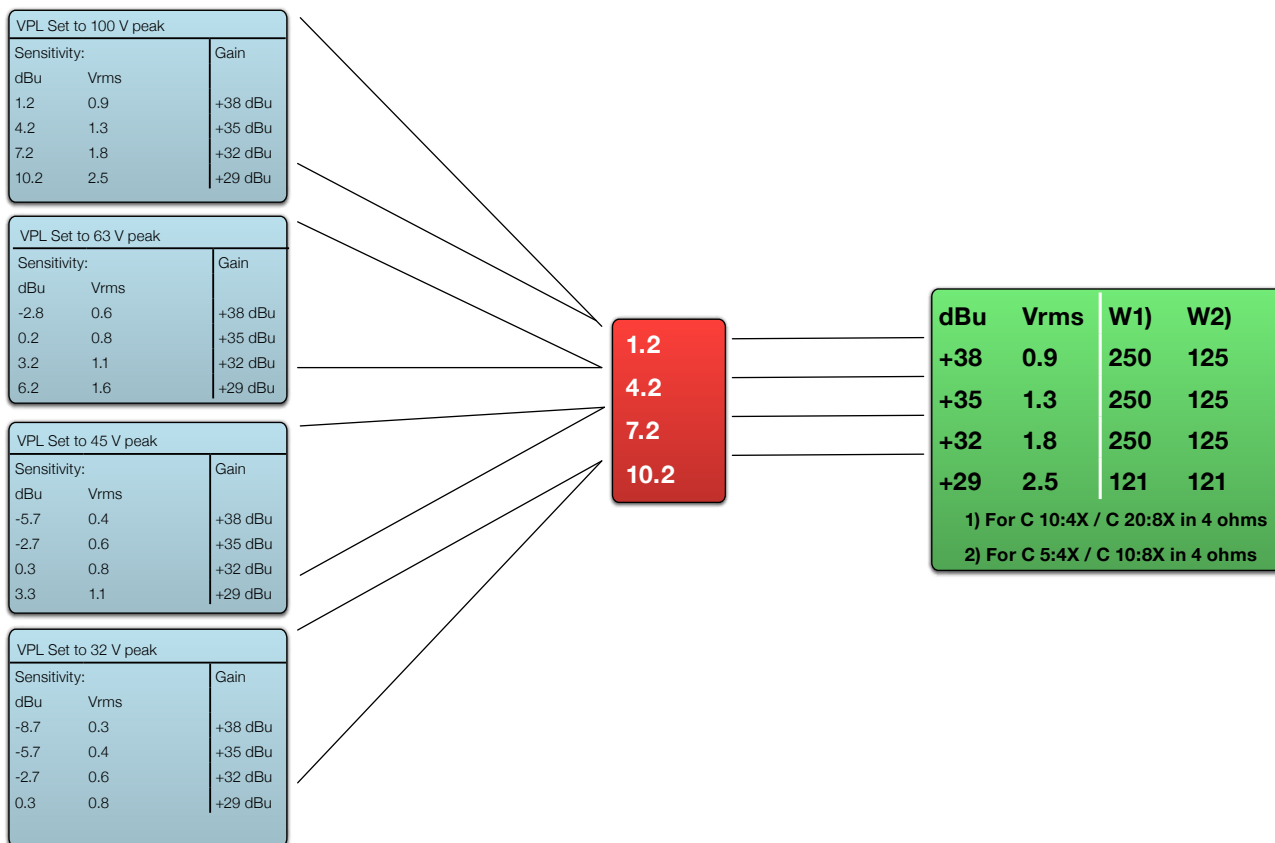

Table 6.5: C...X Series signal flow and VPL to output settings

7. Technical Specifications

Model	C 88:4	C 68:4	C 48:4	C 28:4	C 16:4	C 20:8X	C 10:8X	C 10:4X	C 5:4X
Number of channels	4	4	4	4	4	8	8	4	4
Peak total output all channels driven	8800 W	6800 W	4800 W	2800 W	1600 W	2000 W	1000 W	1000 W	500 W
Peak output voltage per channel	141 V	141 V	141 V	141 V	141 V	100 V / 70 Vrms	100 V / 70 Vrms	100 V / 70 Vrms	100 V / 70 Vrms
Max. output current per channel	35.5 Arms	24.5 Arms	17.5 Arms	12 Arms	8.5 Arms	8 Arms	5.6 Arms	8 Arms	5.6 Arms
Max Output Power									
16 ohms per ch. (all ch.'s driven)	650 W	650 W	625 W	600 W	400 W	250 W	125 W	250 W	125 W
8 ohms per ch. (all ch.'s driven)	1250 W	1200 W	1000 W	700 W	400 W	250 W	125 W	250 W	125 W
4 ohms per ch. (all ch.'s driven)	2100 W	1700 W	1200 W	700 W	300 W	250 W	125 W	250 W	125 W
2 ohms per ch. (all ch.'s driven)	2200 W	1200 W	600 W	300 W	140 W	125 W	60 W	125 W	60 W
Hi-Z per ch. (all ch.'s driven): 70 Vrms / 100 V peak	2200 W	1600 W	1100 W	700 W	400 W	250 W	125 W	250 W	125 W
Hi-Z per ch. (all ch.'s driven): 100 Vrms / 141 V peak	1700 W	1200 W	900 W	700 W	400 W	n.a.	n.a.	n.a.	n.a.
16 ohms Bridged per ch. ¹⁾	2500 W	2400 W	2000 W	1400 W	800 W	500 W	250 W	500 W	250 W
8 ohms Bridged per ch. ¹⁾	4200 W	3400 W	2400 W	1200 W	600 W	500 W	250 W	500 W	250 W
4 ohms Bridged per ch. ¹⁾	4600 W	2400 W	1200 W	600 W	n.r. ⁴⁾	250 W	125 W	250 W	125 W
2 ohms Bridged per ch. ¹⁾	n.r. ⁴⁾	n.r. ⁴⁾	n.r. ⁴⁾	n.r. ⁴⁾	n.r. ⁴⁾	n.r. ⁴⁾	n.r. ⁴⁾	n.r. ⁴⁾	n.r. ⁴⁾
Hi-Z Bridged per ch. ¹⁾ : 140 Vrms / 200 V peak	n.r. ⁴⁾	3200 W	1800 W	1400 W	800 W	500 W	250 W	500 W	250 W
Performance with Gain:									
	35 dB and VPL: 100 V / C 88:4: 35 dB and VPL: 141 V					32 dB and VPL: 100 V			
THD 20 Hz - 20 kHz for 1 W	<0.1%					<0.1%			
THD at 1 kHz and 1 dB below clipping	<0.05%					<0.05%			
Signal To Noise Ratio	>112 dBA					>112 dBA			
Channel separation (Crosstalk) at 1 kHz	>70 dB					>70 dB			
Frequency response (1 W into 8 ohms) +0/-3 dB	6.8 Hz - 34 kHz					6.8 Hz - 34 kHz			
Input impedance	20 kOhm					20 kOhm			
Input Common Mode Rejection, CMR	50 dB					50 dB			
Output impedance @ 100 Hz	30 mOhm					48 mOhm			
Voltage Peak Limiter (VPL), max. peak output									
VPL, selectable per ch. ³⁾	141, 118, 100, 85, 71, 59, 50, 42 V					100, 63, 45, 32 V			
VPL, when bridged ^{3) 1)}	282, 236, 200, 170, 142, 118, 100, 84 V					200, 126, 90, 64 V			
Voltage Peak Limiter mode (per ch.)	Hard / Soft					Hard / Soft			
Gain and Level									
Amplifier gain selectable (all channels) ¹⁾	23, 26, 29, 32, 35, 38, 41, 44 dB					29, 32, 35, 38 dB			
- rear-panel switches									
Default gain	35 dB					32 dB			
Level adjustment (per ch.)	Front-panel potentiometer, 21 position detented from -inf to 0 dB, hidden behind security panel/dust filter grille					Front-panel potentiometer, 21 position detented from -inf to 0 dB, hidden behind security panel/dust filter grille			
Connectors and switches									
Input connectors (per ch.)	3-pin Phoenix, electronically balanced					3-pin Phoenix, electronically balanced			
Output connectors (per ch.)	Barrier strip 2-pole screw terminals					Barrier strip 2-pole screw terminals			
Output bridge mode	A+B and/or C+D, inputs A and C are input source					A+B, C+D, E+F, G+H, inputs A, C, E, G are signal source			
High pass filter	-					Fixed at 35 Hz, switchable per channel			
NomadLink network	On board, 2 x RJ45 connectors IN and OUT					On board, 2 x RJ45 connectors, IN and OUT			
Intelligent fans (on/off)	Yes, depending on presence of output signal					Yes, depending on presence of output signal			
Power on/off and Remote enable on/off	Individual switches on front panel					Individual switches on front panel			
Cooling	Two fans, front-to-rear airflow, temperature controlled speed					Two fans, front-to-rear airflow, temperature controlled speed			
General Purpose Outputs (GPO)	-					Contact Closure types, 2-pole Phoenix			
General Purpose Inputs (GPI)	-					Contact Closure types, 2-pole Phoenix			
Front-panel indicators									
Common	NomadLink Network; Power Average Limiter (PAL) ²⁾ ; Power on					NomadLink [®] Network; Power Average Limiter (PAL) ²⁾ ; Power on			
Per channel	Signal present / High-impedance; -10 dB and -4 dB output signal; Voltage Peak Limiter (VPL); Current Peak Limiter (CPL); Very High Frequency (VHF); High temperature; Fault; Mute					Signal present / High-impedance; Voltage Peak Limiter (VPL); Current Peak Limiter (CPL); Very High Frequency (VHF); High temperature; Fault; Mute			
Power									
Operating voltage, 230 V / 115 V nominal	130-265 V / 65-135 V ⁶⁾					65-265 V			
Minimum power-up voltage, 230 V / 115 V	171 V / 85 V					80 V			
Power Average Limiter (PAL) ²⁾	Yes					Yes			
Soft-start / Inrush Current Draw	Yes / max. 5 A					Yes / max. 5 A			
Mains connector ⁵⁾	230 V CE: 16 A, CEE7; 115 V ETL: 20 A / NEMA 5-20P; C16:4: 15A/NEMA 5-15P					IEC Inlet			
Dimensions (W/H/D)									
	W: 483 mm (19"), H: 88 mm (2 U), D: 343 mm (13.5")					W: 483 mm (19"), H: 88 mm (2 U), D: 343 mm (13.5")			
Weight	12 kg (26.4 lbs.)					8.5 kg (18.75 lbs.)			
Finish	Black painted steel chassis with gray painted steel front					Black painted steel chassis with gray painted steel front			
Approvals	CE, ANSI/UL 60065 (ETL), CSA C22.2 NO. 60065, FCC					CE, ANSI/UL 60065 (ETL), CSA C22.2 NO. 60065, FCC			

Note 1): Automatic -6 dB gain compensation when bridging channels. Ch.'s A+B and/or C+D, E+F, G+H, can be bridged individually.

Note 2): PAL can reduce the maximum output power to keep the power supply operating safely, and/or to prevent excessive current draw tripping the mains breaker. Refer to Operation Manual.

Note 3): For sine waves, peak voltage output values translate to Vrms with the formula $V/1.41 = Vrms$. E.g. 100 V peak equals app. 70 V rms. Hence, outputs can be set for high-impedance loads without requiring a transformer.

Note 4): Regarding n.r. (not recommended) notes: The amplifier will be fully operational in bridge-mode into 2 ohm and high impedance (Hi-Z) loads, but due to physical constraints in the construction, the max. output power will not be significantly higher than running individual channels and therefore this mode of operation is not recommended.

Note 5): C 88:4 mains connector: 30 A Twist lock.

Note 6): Separate 230 V or 115 V versions available. Not selectable on the amplifier.

8. Warranty and Support

8.1. General

This product is manufactured by LAB GRUPPEN, and it is warranted to be free from any defects caused by components or factory workmanship, under normal use and service, for a period of six (6) years from date of purchase from an authorized LAB GRUPPEN dealer. If the product fails to perform as specified during the warranty period, LAB GRUPPEN will undertake to repair, or at its option, replace this product at no charge to its owner, provided the unit is returned undamaged, shipping prepaid, to an authorized service facility or to the factory. This warranty shall be null and void if the product is subjected to: repair work or alteration by a person other than those authorized by us; mechanical damage including shipping accidents; war, civil insurrection, misuse, abuse, operation with incorrect AC voltage; incorrect connections or accessories; operation with faulty associated equipment; or exposure to inclement weather conditions. Damage due to normal wear and tear is not covered by the warranty. Units on which the serial number has been removed or defaced will not be eligible for warranty service. LAB GRUPPEN shall not be responsible for any incidental or consequential damages. LAB GRUPPEN's responsibility is limited to the product itself. LAB GRUPPEN takes no responsibility for any loss due to cancellation of any events, or rent of replacement equipment or costs due to a third party's or customer's loss of profit, or any other indirect cost or losses however incurred. LAB GRUPPEN reserves the right to make changes or improvements in design or manufacturing without assuming any obligation to change or improve products previously manufactured. This warranty is exclusive, and no other warranty is expressed or implied. This warranty does not affect the customer's statutory rights.

International Warranties

Please contact your supplier or distributor for this information, as rights and disclaimers may vary from country to country.

8.2. Technical assistance and service

8.2.1. International service

If your LAB GRUPPEN product requires repair, contact your LAB GRUPPEN dealer or distributor, visit <http://labgruppen.com/support> or contact LAB GRUPPEN by phone or email to obtain details for the nearest authorized service center.

8.2.2. Factory service

In the event a LAB GRUPPEN product requires factory service, you may contact LAB GRUPPEN's service department for return instructions and a Return Authorization number.

Please note for product return:

1. Use the original packing.
2. Include a copy of the sales receipt, your name, return address, phone and fax number, email address and description of the defect.
3. Mark the Return Authorization number on the outside of the packing.

Ship the product prepaid to:

Music Group Innovation Sweden AB
Faktorvägen 1
SE-434 37 Kungsbacka
Sweden
Phone: +46 300 56 28 00
Fax: +46 300 56 28 99

service@labgruppen.com www.labgruppen.com

Notes

Notes

labgruppen.com

Intercooler, Class TD, R.SMPS, VPL, BEL, UVL and CAL are national and/or international trademarks or registered trademarks of Music Group.
All other trademarks remain the property of their respective owners.

Copyright © 2016 MUSIC Group Innovation Sweden AB. All rights reserved.