

Handheld Transmitter Version / Bodypack Transmitter Version

USER MANUAL – Section 1

The warnings contained in this manual as well as the information listed in “USER MANUAL - Section 2” must be complied with.

RED CERTIFICATION

This equipment is in conformity with RED directive 2014/53/EU in reference to the following harmonized standards:

Health	EN 62479:2010
Safety	EN 62368-1:2014+A11
EMC	EN 301 489-1 v2.2.0, EN 301 489-9 v2.1.1, EN 301 789-17 V3.2.0, EN 55032:2015, EN 55035:2017
Spectrum	EN 301 422-1 v2.1.2, EN 300 328 v2.1.1

EMI CLASSIFICATION

According to the standards EN 55032 and EN 55035 this equipment is designed and suitable to operate in class B electromagnetic environments.

FCC AND IC CERTIFICATION

FCC ID: 2ADDV-BHYPEM (Bluetooth® transmitter)
FCC ID: 2ADDV-HTBHM (Handheld transmitter)
FCC ID: 2ADDV-BTBHM (Bodypack transmitter)
IC: 12207A-BHYPEM (Bluetooth® transmitter)
IC: 12207A-HTBHM (Handheld transmitter)
IC: 12207A-BTBHM (Bodypack transmitter)

This equipment has been designed and complies with the safety requirements for portable (<20 cm) RF exposure in accordance with FCC rule part 2.1091. Installers must ensure that this device must not be co-located or operated in conjunction with any other antenna or transmitter except in accordance with FCC multi-transmitter product procedures.

NOTICE

For USA Market:

This equipment has been tested and found to comply with the limits for a Class B digital device, pursuant to part 15 of the FCC Rules. These limits are designed to provide reasonable protection against harmful interference in a residential installation. This equipment generates, uses and can radiate radio frequency energy and, if not installed and used in accordance with the instructions, may cause harmful interference to radio communications. However, there is no guarantee that interference will not occur in a particular installation. If this equipment does cause harmful interference to radio or television reception, which can be determined by turning the equipment off and on, the user is encouraged to try to correct the interference by one or more of the following measures:

- Reorient or relocate the receiving antenna.
- Increase the separation between the equipment and receiver.
- Connect the equipment into an outlet on a circuit different from that to which the receiver is connected.
- Consult the dealer or an experienced radio/TV technician for help.

Changes or modifications not expressly approved by the party responsible for compliance could void the user's authority to operate the equipment.

The Bluetooth® word mark and logos are registered trademarks owned by Bluetooth® SIG, Inc. and any use of such marks by AEB Industriale SRL is under license. Other Trademarks and trade names are those of their respective owner.

CONSUMER ALERT

Most users do not need a license to operate this wireless system. Nevertheless, operating this microphone system without a license is subject to certain restrictions: The system may not cause harmful interference; it must operate at a low power level (not in excess of 50 milliwatts); and it has no protection from interference received from any other device. Purchasers should also be aware that the FCC is currently evaluating use of wireless microphone systems, and these rules are subject to change. For more information, call the FCC at 1-888-CALL-FCC (TTY: 1-888-TELL-FCC) or visit the FCC's wireless microphone Web site at <http://www.fcc.gov/cgb/wirelessmicrophones>.

For Canadian Market:

This device complies with Industry Canada's license-exempt RSSs.

Operation is subject to the following two conditions:

- (1) This device may not cause interference; and
- (2) This device must accept any interference, including interference that may cause undesired operation of the device.

This device operates on a no-protection no-interference basis. Should the user seek to obtain protection from other radio services operating in the same TV bands, a radio license is required.

Please consult Industry Canada's document CPC-2-1-28, Optional Licensing for Low-Power Radio Apparatus in the TV Bands, for details.

IMPORTANT SAFETY INSTRUCTIONS:

1. Read these instructions
2. Keep these instructions.
3. Heed all warnings.
4. Follow all instructions.
5. Do not use this apparatus near water.
6. Clean only with dry cloth.
7. Do not block any ventilation openings. Install in accordance with the manufacturer's instructions.
8. Do not install near any heat sources such as radiators, heat registers, stoves, or other apparatus (including amplifiers) that produce heat.
9. Do not defeat the safety purpose of the polarized or grounding-type plug. A polarized plug has two blades with one wider than the other. A grounding type plug has two blades and a third grounding prong. The wide blade or the third prong are provided for your safety. If the provided plug does not fit into your outlet, consult an electrician for replacement of the obsolete outlet.
10. Protect the power cord from being walked on or pinched particularly at plugs, convenience receptacles, and the point where they exit from the apparatus.
11. Only use attachments /accessories specified by the manufacturer.



12. Use only with the cart, stand tripod, bracket, or table specified by the manufacturer, or sold with the apparatus. When a cart is used, use caution, when moving the cart/apparatus combination to avoid injury from tip-over.
13. Unplug this apparatus during lightning storms or when unused for long periods of time.
14. Refer all servicing to qualified service personnel. Servicing is required when the apparatus has been damaged in any way, such as power-supply cord or plug is damaged, liquid has been spilled or objects have fallen into the apparatus has been exposed to rain or moisture, does not operate normally, or has been dropped.

ADDITIONAL SAFETY INSTRUCTIONS:

- No naked flame sources, such as lighted candles, should be placed on the apparatus
- Do not use the apparatus in tropical climates

TABLE OF CONTENTS

1. GENERAL INFORMATION AND MAIN SECTIONS	24
WELCOME!	24
PACKAGE CONTENTS.....	24
USER REFERENCE.....	24
MECHANICS	25
OVERVIEW OF THE EQUIPMENT	25
POWER SUPPLY UNIT SECTION.....	26
SECTION FOR THE CONNECTIONS, CONTROL AND MONITORING OF THE BATTERY.....	26
MEDIA PLAYER INTERFACE.....	27
2. ANTENNAE, RECEIVER AND TRANSMITTERS	29
R-BHM	29
HT-BHM	30
HOUSING WITH BATTERY CHARGER FOR HT-BHM	30
BT-BHM.....	31
SYNCHRONISATION OF THE TRANSMITTER.....	32
SUMMARY TABLE OF CHANNELS AND FREQUENCIES.....	33
CHANGE OF FREQUENCY BAND	34
3. TROUBLESHOOTING	35
4. ACCESSORIES/SPARE PARTS	36
5. SPECIFICATIONS	37
GENERAL.....	37
ACOUSTICAL SPECIFICATIONS.....	37
INTERNAL BATTERY	37
AMPLIFIER.....	37
USER INTERFACE	38
INPUTS & OUTPUTS.....	38
RF SECTION	38
POWER SUPPLY SPECIFICATIONS (ABSORPTION / INSTALLATION)	38
DIMENSIONS.....	39

1. GENERAL INFORMATION AND MAIN SECTIONS

WELCOME!

Thanks for purchasing a dBTechnologies product! B-HYPE MOBILE is a mobile bi-amplified multimedia speaker available in 2 versions:

- a bundle with wireless handheld transmitter (handheld radio microphone)
- a bundle with bodypack transmitter and headset with microphone

The wireless system is available in 3 frequency bands (also according to the Country of sale). It can work both with network connection and with batteries. It can be reconfigured at any time thanks to the different accessories available.

PACKAGE CONTENTS

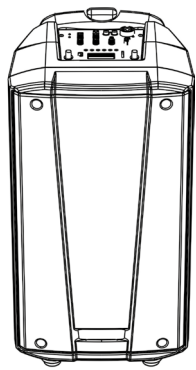

B-HYPE MOBILE

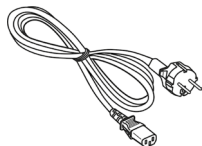

POWER SUPPLY CABLE

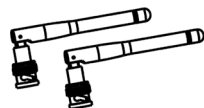

ANTENNAE



DOCUMENTATION

PART IN COMMON FOR BOTH BUNDLES

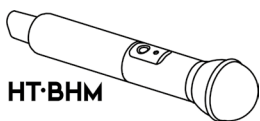

HT·BHM



BT·BHM



HM·BHM

PART DEPENDING ON BUNDLE/ACCESSORIES SOLD ALSO SEPARATELY

USER REFERENCE

To make the most of your B-HYPE MOBILE, we recommend that you:

- read the quick start user manual included in the package and this user manual thoroughly and keep this manual during the whole life of the product.
- comply carefully with the rules for use and storage of the batteries (transmitters)
- Register your product at <http://www.dbtechnologies.com> under “[SUPPORT](#)”.
- keep proof of purchase and WARRANTY (User manual “section 2”).

MECHANICS

B-HYPE MOBILE is equipped with:

1. side handles
2. housing for the HT-BHM radio microphone
3. wheels for handling
4. upper handle (with central release button)

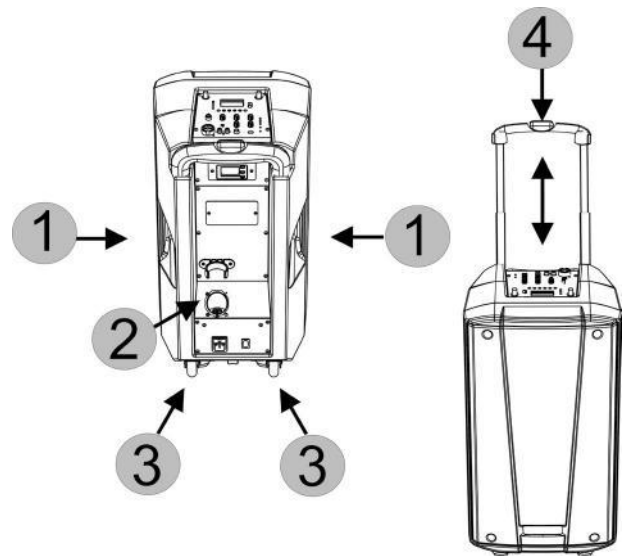

OVERVIEW OF THE EQUIPMENT

On the upper side and at the back of the speaker there are:

5. media player interface
6. control and connection section
7. R-BHM receiver module
8. lithium-ion battery compartment
9. battery charger with LED for HT-BHM radio microphone
10. power supply unit section

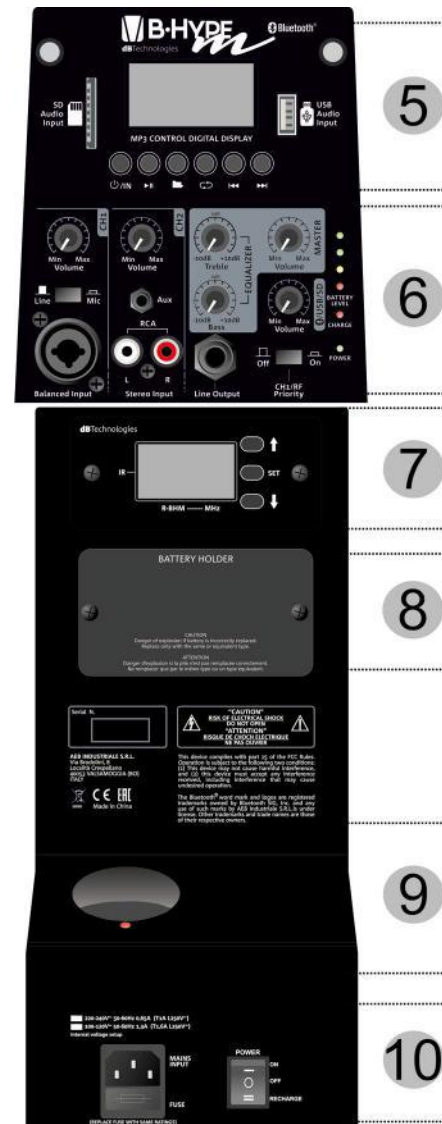

WARNING!

Avoid any direct contact with water or environments that are too humid during use.

Avoid any direct exposure to sunlight for long periods.

Ensure good aeration around the loudspeaker to facilitate heat dissipation.

Never attempt to open or access the amplifier panel or the loudspeaker acoustic components.

Follow the instructions listed in this manual.

POWER SUPPLY UNIT SECTION

This section contains:

- connector for the supplied power supply cable
- three-state switch:

ON - full operation of all functions and operation both with network cable and with battery only in mobile mode.

OFF - no operation (device completely off)

RECHARGE - the system in stand-by, connected to the network, recharges the inner battery and the BT-BHM radio microphone, if any.

220-240V~ 50-60Hz 0,65A (T1A L250V~)
 100-120V~ 50-60Hz 1,3A (T1,6A L250V~)
 Internal voltage setup

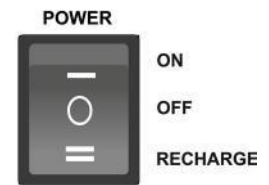

SECTION FOR THE CONNECTIONS, CONTROL AND MONITORING OF THE BATTERY

This section contains inputs/outputs and volume mixer adjustments. All monitoring LEDs of the system and of the internal battery are also present. In particular, the following can be found:

- CH1: Combo connector (XLR/TRS) with relevant input type switch and volume rotary switch. If a microphone is connected, select the position Mic.
- CH2: The connectors available are AUX (3.5 mm mini-jack) and RCA stereo with relevant volume rotary switch of the channel.
- MASTER SECTION (3 rotary switches): general volume switch, TREBLE and BASS equalization rotary switches.
- VOLUME ROTARY SWITCH /USB/SD: it controls the volume of the playable media (see section “MEDIA PLAYER INTERFACE” for further information)
- Line Output: unbalanced connector to link the B-HYPE MOBILE output to another active loudspeaker (e.g. another B-HYPE MOBILE system). For example, the Line Output of a B-HYPE MOBILE can be connected to the CH1 of a second one to obtain a distributed system.
- CH1/RF Priority. In “On” position the audio level of the 2 channels CH2 and /USB/SD is immediately reduced by the presence of a signal on CH1 or on the radio frequency microphone.

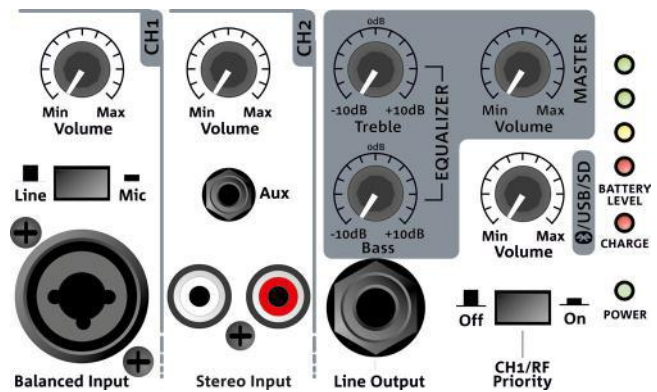

The monitoring LEDs of the system and of the internal battery provide immediate information to the user.

The POWER LED indicates whether B-HYPE MOBILE is on (green light) or off.

The internal battery will recharge with B-HYPE MOBILE connected to the power mains (through the cable supplied) and in RECHARGE position. The recharge is carried out in a less efficient manner also during the operation in ON position. The CHARGE LED is red if the battery is flat, and green when completely charged.







When B-HYPE MOBILE is used in mobile mode (without power supply cable), in ON, the Battery level LEDs turn on depending on the battery charge status.

MEDIA PLAYER INTERFACE

This section contains the controls and inputs to play .mp3, .wav, .wma files from:



- SD cards
- USB memory device
-  Bluetooth® device correctly paired

To play a file from the SD card / USB device:

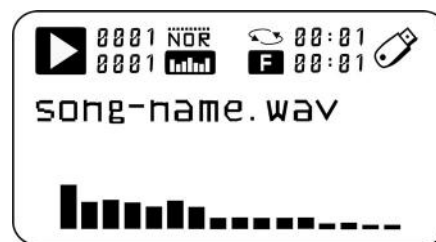
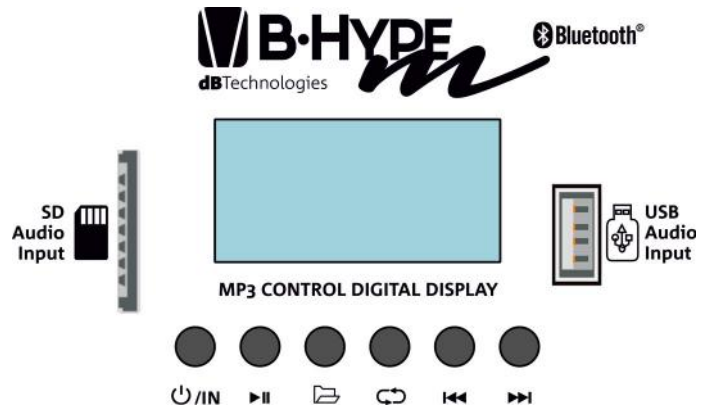
1. Turn B-HYPE MOBILE on after connecting the power supply cable (switch in ON position). For further information, see paragraph "POWER SUPPLY UNIT SECTION".
2. Insert the correct device in the relevant input (see figure on the side). Note: it is possible to use only one device at a time
3. Press the switch-on button  of the player for a few seconds. Once the display is on, push the button shortly to select the source type.
4. Press the buttons      respectively to: play/pause the track, search through the folders, automatically repeat the track/access the equalization, rewind, fast forward.
5. Adjust the 2 volumes of the mixer area (see section "SECTION FOR CONNECTIONS AND CONTROL"):
 - MASTER volume
 - Volume 



To play the file from a  Bluetooth® device:

1. Turn B-HYPE MOBILE on after connecting the power supply cable (switch in ON position). For further information, see paragraph "POWER SUPPLY UNIT SECTION".
2. Press the switch-on button  of the player for a few seconds. Once the display is on, push the button shortly to select the source type.
3. Enable the  Bluetooth® function on the player/ device containing the audio track, checking that its visibility is enabled.
4. Once communication is established the name of the device is shown on display.
5. Adjust the 2 volumes of the mixer area (see section "SECTION FOR CONNECTIONS AND CONTROL"):
 - MASTER volume
 - Volume 

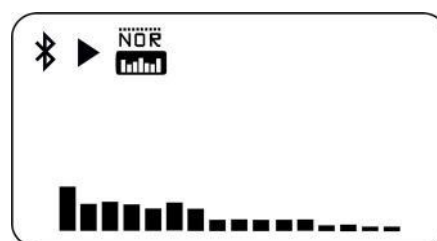

The diagram below shows a summary of the input/output possibilities of B-HYPE MOBILE.

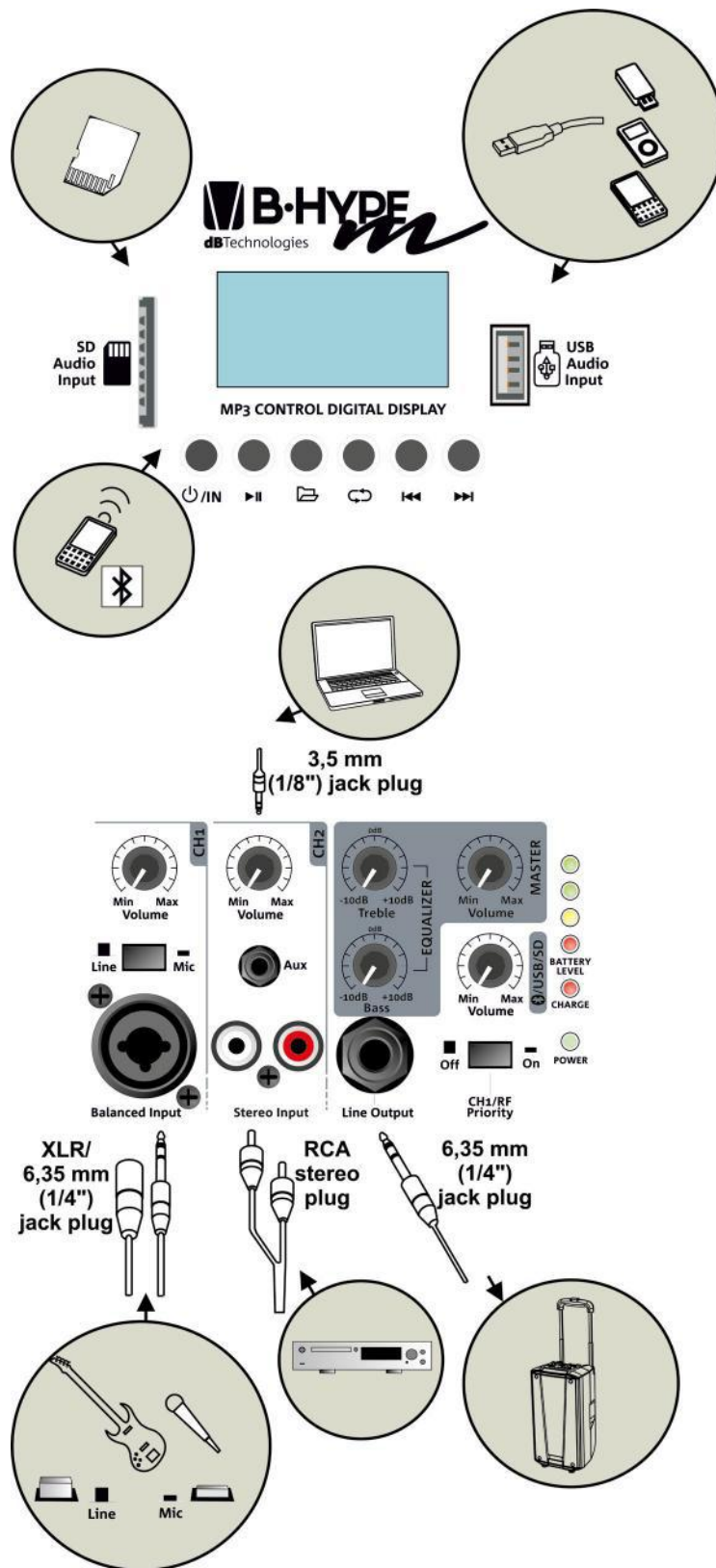

2. ANTENNAE, RECEIVER AND TRANSMITTERS

The B-HYPE MOBILE system is equipped, depending on the purchased bundle, of a handheld radio microphone or bodypack.

Based on the availability and on the Country of use, the system is sold in one of the following three frequency bands:

- 542-566 MHz
- 638-662 MHz
- 863-865 MHz

To enable the radio transmission/reception it is necessary to install the supplied antennae on the upper side of B-HYPE MOBILE, as shown in the figures on the side.



R-BHM

The R-BHM receiver is on the back of the system. It is equipped with a display and three buttons that allow the synchronisation with the radio microphone and provide real time information on the transmitter/receiver communication.

In particular, the display (see figure on the side) shows:

- CHANNEL (it shows the number of the channel being used among the ones available)
- FREQUENCY (frequency of the channel)
- BATTERY LEVEL (battery level of the transmitter)
- MIC MUTE (mute setting of the radio microphone)
- AF/RF (signal level of the radio microphone/squelch of the radio signal)

Buttons:

X (symbol ): increases a value / allows the synchronisation if pressed for a few seconds
 Y (symbol ): allows accessing the AF and RF adjustment page in sequence to set their levels
 Z (symbol ): decreases a value

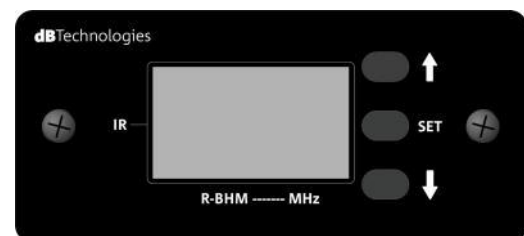
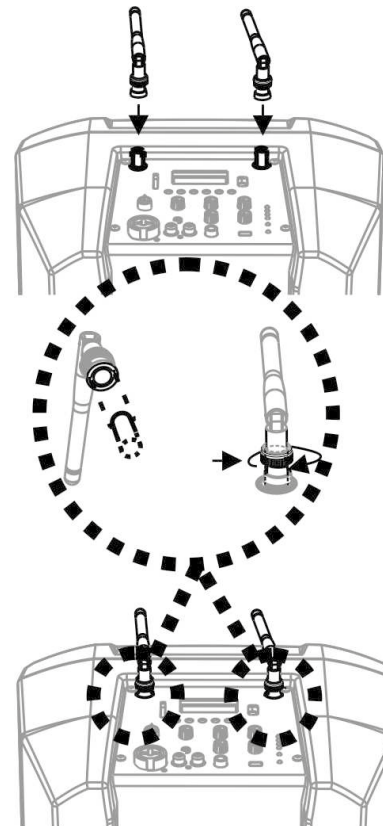

MIC MUTE AF/RF

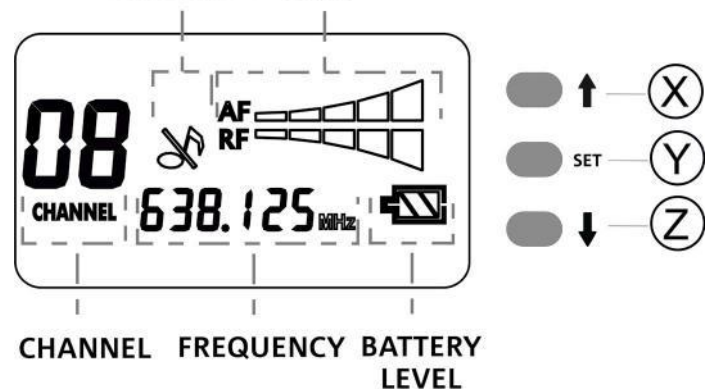

AF = AUDIO VOLUME INTENSITY
 RF = WIRELESS RECEPTION INTENSITY

HT-BHM

The handheld transmitter (handheld radio microphone) is equipped with:

- A - Status LEDs
- B - ON/OFF/MUTE BUTTON (depending on whether it is pressed for a few seconds or instantaneously, it turns on/ mutes/turns off the microphone)
- C - IR lens useful during synchronisation of the device with the R-BHM receiver
- D - Rotary switch for gain adjustment
- E - Micro screwdriver for gain adjustment [D]
- F - Removable cover of the battery housing (placed on the back)

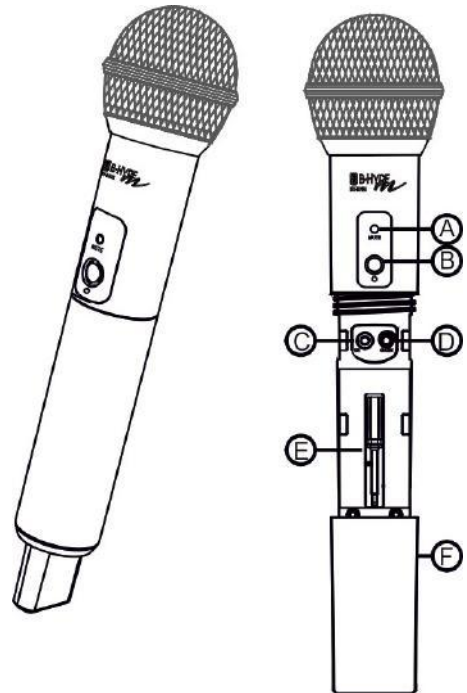

WARNING!
 On HT-BHM, the use of RECHARGEABLE AA batteries of the Ni-MH type (not supplied) is required. The use of Lithium, Alkaline, Ni-Cd or other types of batteries is not allowed.

Batteries are inserted by unscrewing the cover [F] and inserting the batteries of the type indicated above, following the correct polarity.
 If the radio microphone is not used for a long period, remove the batteries from the device and store them in a suitable place.

To use HT-BHM with B-HYPE MOBILE see the synchronisation procedure in the relevant paragraph.

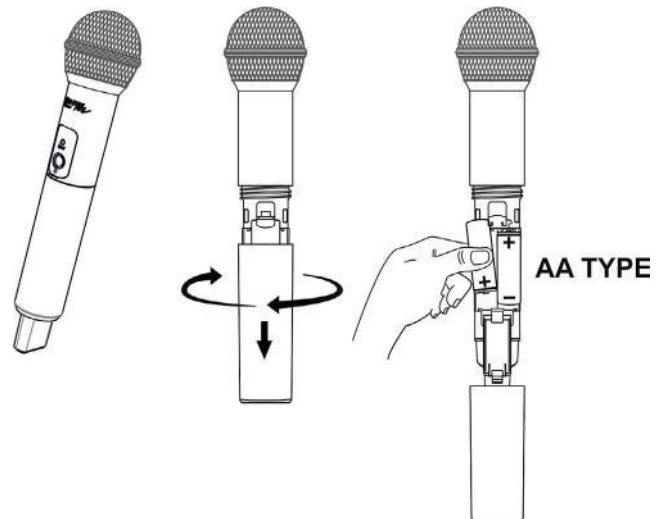

HOUSING WITH BATTERY CHARGER FOR HT-BHM

With B-HYPE MOBILE in ON or RECHARGE mode, if HT-BHM is correctly inserted in the housing on the back, an appropriate circuit will recharge the batteries (Ni-MH rechargeable batteries).

The LED of the housing can be:

- RED - the battery is charging
- GREEN - the battery has completed its recharge cycle
- FLASHING RED - the protection circuit has identified an incorrect battery type in the radio microphone. Replace them immediately with the appropriate type (Ni-MH)

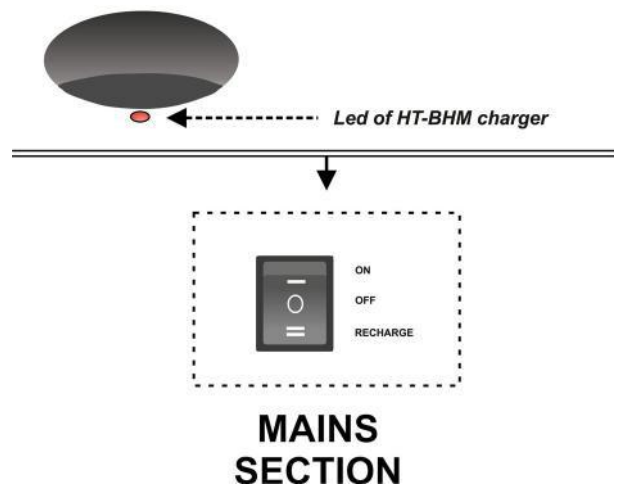

MAINS SECTION

BT-BHM

The bodypack transmitter is equipped with:

- G - Antenna
- H - Status LEDs
- I - ON/OFF/MUTE BUTTON (depending on whether it is pressed for a few seconds or instantaneously, it turns on/ mutes/turns off the microphone)
- M - Micro screwdriver for gain adjustment [N]
- N - Rotary switch for gain adjustment
- O - IR lens useful during synchronisation of the device with the R-BHM receiver
- P - Removable cover of the battery housing

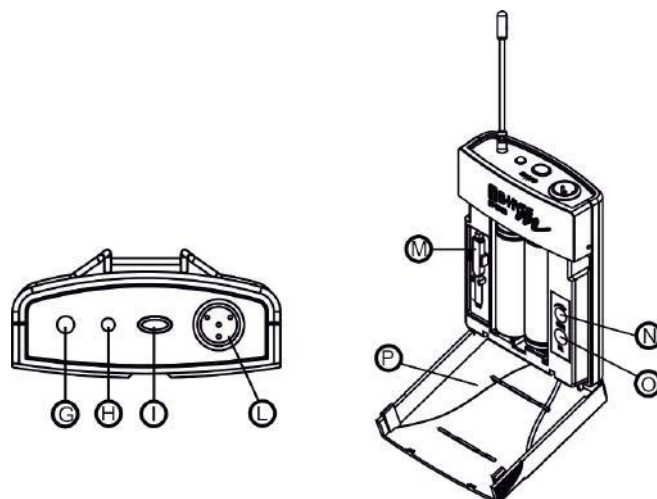

On BT-BHM it is possible to use any type of batteries. Its use is not bound to the battery charger of B-HYPE MOBILE.

Batteries are inserted by opening the cover [P] and inserting the batteries following the correct polarity. If the radio microphone is not used for a long period, remove the batteries from the device and store them in a suitable place.

To use BT-BHM with B-HYPE MOBILE see the synchronisation procedure in the relevant paragraph.

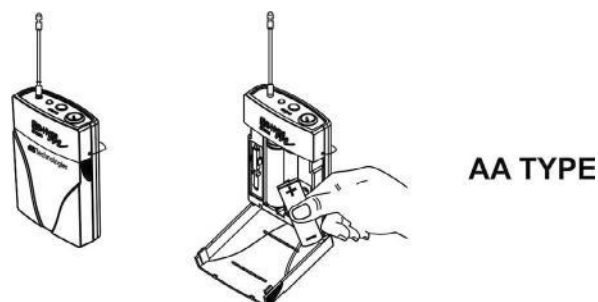

SYNCHRONISATION OF THE TRANSMITTER

To play a file from the SD card / USB device:

1. Turn B-HYPE MOBILE on after connecting the power supply cable (switch in ON position). Check that the MASTER volume is on a medium/low level.
2. Open the battery compartments of the transmitters as shown in the previous sections.
3. Shortly press the button ON/OFF/MUTE on the transmitter.
4. Select a channel with the keys X (↑ symbol) and Z (↓ symbol) on the R-BHM receiver.
5. Hold key X (↑ symbol) pressed for a few seconds on receiver R-BHM: the CHANNEL values on the display will start flashing.
6. Position the IR lens of the transmitter in front of the display of R-BHM. The correct distance is maximum of approx. 15-30 cm.
7. Synchronisation will be carried out in a few seconds and the CHANNEL values on the display will stop flashing.
8. Adjust the gain on the transmitter using the relevant rotary switch and the supplied micro screwdriver.
9. Place the cover of the battery back on the transmitter.

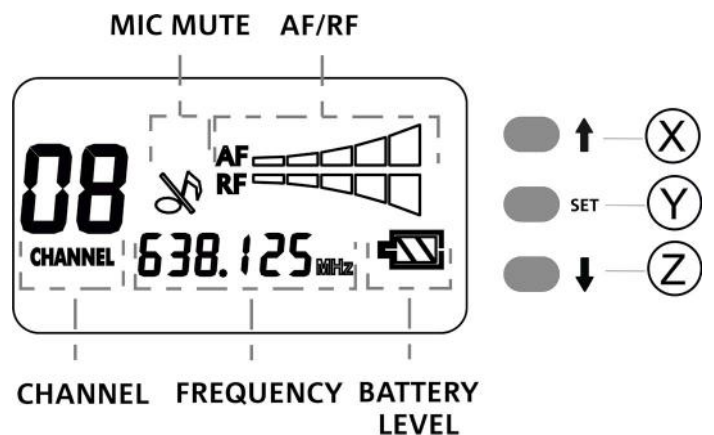
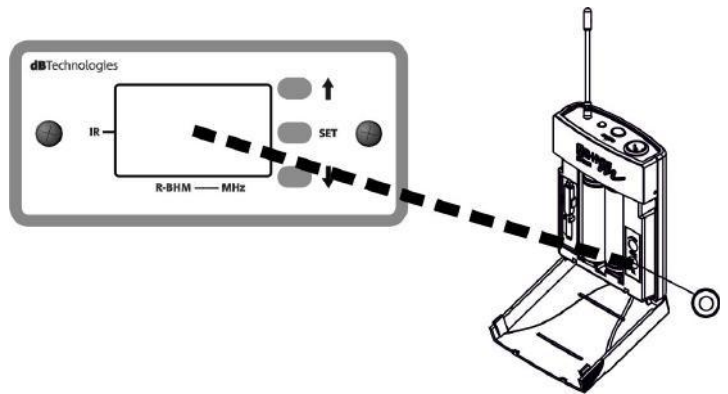
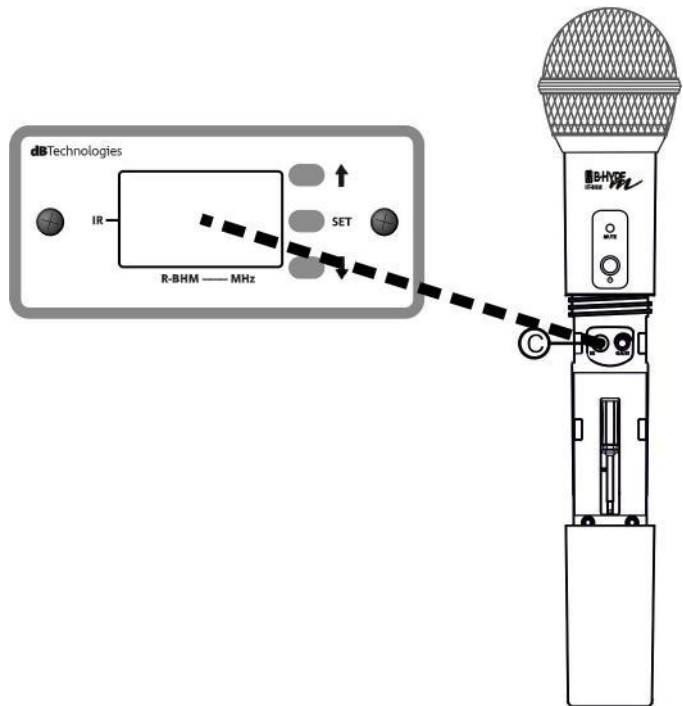

SUMMARY TABLE OF CHANNELS AND FREQUENCIES

542 - 566 MHz	
542 543 544 545 546 547 548 549 550 551 552 553 554 555 556 557 558 559 560 561 562 563 564 565 566	
Channel	Frequency
1	542.125 MHz
2	547.300 MHz
3	547.825 MHz
4	551.850 MHz
5	554.500 MHz
6	562.350 MHz
7	563.725 MHz
8	565.825 MHz

638 - 662 MHz	
638 639 640 641 642 643 644 645 646 647 648 649 650 651 652 653 654 655 656 657 658 659 660 661 662	
Channel	Frequency
1	638.575 MHz
2	639.075 MHz
3	640.900 MHz
4	649.150 MHz
5	652.100 MHz
6	655.875 MHz
7	656.875 MHz
8	661.150 MHz

863 - 865 MHz*	
863 864 865	
Channel	Frequency
1	863.025 MHz
2	863.175 MHz
3	863.475 MHz
4	863.625 MHz
5	864.375 MHz
6	864.525 MHz
7	864.825 MHz
8	864.975 MHz

*** NOT AVAILABLE FOR 100-120V~ PRODUCTS**

CHANGE OF FREQUENCY BAND

In particular cases and when necessary, it is possible to reconfigure the transmitter-receiver frequency band. To do this you need to purchase a new transmitter and a new receiver, both operating in the new band. The 3 bands shown in the previous page could not be all available, depending on the Country of sale (refer to your authorised dealer).



WARNING!

The operation must be carried out with product turned off and disconnected from the power mains. It must be carried out by qualified personnel in order to prevent any electrostatic discharge (ESD) that could damage the product.

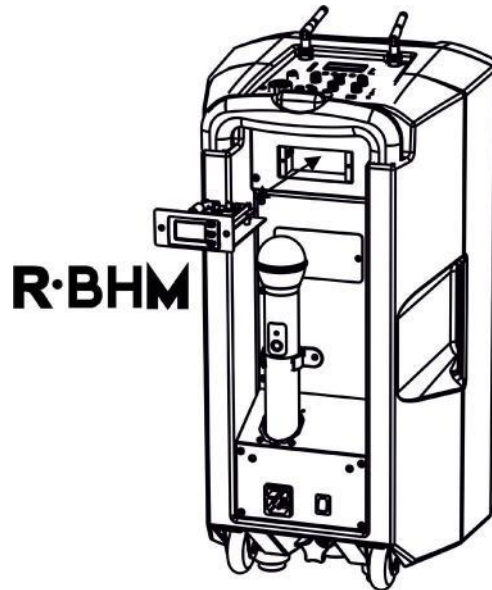

The procedure requires to replace the receiver installed on B-HYPE MOBILE and then proceed with the synchronisation with a new radio microphone that works in the new selected band. To replace the R-BHM receiver:

- With device off, disconnect any audio and power supply wiring.
- Loosen the 2 screws of R-BHM
- Partially remove the receiver and disconnect the three mini-connectors shown:

C1 - 3-pin connector (power supply-audio)

C2 - 2-pin connector (antenna A)

C3 - 2-pin connector (antenna B)

- Bring the new R-BHM operating in the new band closer
- Connect C1, C2, C3
- Completely insert R-BHM
- Tighten the 2 screws of R-BHM

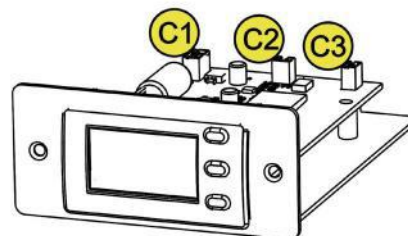
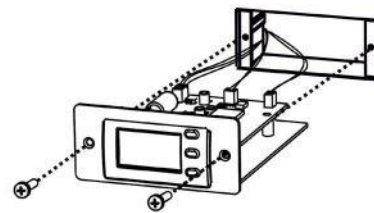

For full functionality, synchronise the transmitter/receiver as shown in the relevant paragraph.

3. TROUBLESHOOTING

The loudspeaker will not turn on:

1. Check that power supply is present upstream of the installation.
2. Ensure that the power supply cable with VDE connector is properly plugged in.
3. Check that the turning on switch is set to "ON".
4. If in "mobile" mode use, check that the battery is charged. If this is not the case, charge it by connecting B-HYPE MOBILE to the power mains and selecting "RECHARGE" mode.

The loudspeaker turns on but does not play an audio track:

1. Check that the input connections of the audio signal, as described on page 9, are carried out correctly. If present, check the visibility and pairing of Bluetooth® devices.
2. Check the cables for damage.
3. Ensure that the mixer or audio source is on and an output signal is present.
4. Check that the input levels are appropriate.

The bodypack or handheld radio microphone does not work

1. Check the battery status of the radio microphone (shown on the receiver display). Replace the batteries, if necessary.
2. Check the levels in the SECTION FOR CONNECTIONS AND CONTROL
3. Check and act on the receiver AF/RF levels.
4. Check the gain on the radio microphone.
5. If necessary, carry out a new synchronisation procedure on a different channel. Refer to the relevant section.

A noise or interference on the background can be heard when using the radio microphone:

1. Adjust the gain of the radio microphone
2. Act on the RF squelch parameter in the receiver
3. If necessary, change the transmission/reception channel (performing a new synchronisation on this channel, if necessary)

4. ACCESSORIES/SPARE PARTS

Accessories/spare parts available are:

- R-BHM Receiver module*
- BT-BHM Bodypack transmitter*
- HT-BHM Handheld transmitter (handheld radio microphone)*
- HM-BHM Black headset
- HM-BHM TAN Beige headset

* available in 3 frequency bands, according to the Country of sale:

- 542-566 MHz
- 638-662 MHz
- 863-865 MHz

Check new accessories/spare parts availability on the website www.dbtechnologies.com

5. SPECIFICATIONS

GENERAL

Type:	Mobile 2-way loudspeaker with battery and radio microphone
-------	--

ACOUSTICAL SPECIFICATIONS

Frequency response [-10dB]:	62 - 20000 Hz
Frequency response [-6dB]:	66 - 18100 Hz
Max SPL:	123 dB
HF voice coil:	1"
HF compression driver (output):	1"
LF:	10"
LF Voice coil:	1.5"
Crossover frequency (24 dB/oct):	2400 Hz
Coverage (HxV):	90° x 45°

INTERNAL BATTERY

Type:	Li - Ion (25.9 V - 2200 mAh)
Recharge time:	approx. 4 hours
Duration in medium conditions of usage:	up to 4 hours

AMPLIFIER

Type:	AMP SMPS
Amplification class:	Class D

RMS amplifier power:	95 W
Peak power:	190 W

USER INTERFACE

Controls:	MIXER con livelli e selettori degli ingressi, CH1/RF priority
-----------	---

INPUTS & OUTPUTS

Inputs:	1x COMBO Input, 1x Aux (3.5 mm mini-jack), 1x stereo RCA, Bluetooth®, SD-Card slot, USB type A port
Outputs:	1x TRS line OUT
Power supply:	1x VDE

RF SECTION

Available bands:	542-566 / 638-662 / 863-865 MHz (bundle di fabbrica)
Channels selectable per band:	8
Transmission range:	fino a 35 m

POWER SUPPLY SPECIFICATIONS (ABSORPTION / INSTALLATION)

Absorption at 1/8th of power in medium use conditions (*):	0.35 A (230 V) - 0.57 A (115 V)
Absorption at 1/3rd of power in maximum use conditions (**):	0.65 A (230 V) - 1.3 A (115 V)
Absorption with speaker on in no-signal condition (idle):	16 W

* **NOTE FOR INSTALLER:** Values refer to 1/8th of power, under average operating conditions (music programme with occasional or no clipping). For any type of configuration we recommend to consider them as minimum sizing values.

** **NOTE FOR INSTALLER:** Values refer to 1/3rd of power, under heavy operating conditions (music programme with frequent clipping and limiter activation). In case of professional installations and tours we recommend sizing according to these values.

DIMENSIONS

Material:	Plastic cabinet
Grille:	Metal
Width:	300 mm
Height:	568 mm
Depth:	301 mm
Weight:	12,5 kg

Product features, specifications and appearance are subject to changes without prior notice. dBTechnologies reserves the right to make changes or improvements in design or manufacture without any obligation to incorporate such changes or improvements in products manufactured before their introduction.



A.E.B. Industriale Srl
Via Brodolini, 8
Località Crespellano
40053 VALSAMOGGIA
BOLOGNA (ITALIA)

Tel +39 051 969870
Fax +39 051 969725

www.dbtechnologies.com
info@dbtechnologies-aeb.com