

T-Series

Rigging manual (1.1 EN)

References in the manual



WARNING!

This refers to a potentially dangerous situation which may lead to personal injury and/or damage to the equipment and/or material.



CAUTION!

This refers to a potentially dangerous situation which may lead to damage to the equipment or material.

NOTICE: This refers to a situation which may lead to damage to the equipment or material or cause the equipment to malfunction.

Note: Additional information and/or references.

Symbols on the equipment



Please refer to the information in the operating manual.

General Information

T-Series
Rigging manual

Version 1.1 EN, 02/2009, D2993.EN .01

Copyright © 2009 by d&b audiotechnik GmbH; all rights reserved.

Keep this manual with the product or in a safe place so that it is available for future reference.

When reselling this product, hand over this manual to the new customer.

If you supply d&b products, please draw the attention of your customers to this manual. Enclose the relevant manuals with the systems. If you require additional manuals for this purpose, you can order them from d&b.

d&b audiotechnik GmbH
Eugen-Adolff-Strasse 134, D-71522 Backnang, Germany
Telephone +49-7191-9669-0, Fax +49-7191-95 00 00
E-mail: docadmin@dbaudio.com, Internet: www.dbaudio.com

Contents

1. Safety precautions.....	4
1.1. Intended use.....	4
1.1.1. Load capacity/System safety.....	4
1.1.2. ArrayCalc / TI 385.....	5
1.2. Operational safety.....	5
2. T-Series rigging concept.....	6
2.1. Z5370 T Flying frame.....	6
2.1.1. System components overview.....	7
2.1.2. Flying frame dimensions.....	8
2.2. T-Series Locking pins.....	9
2.3. T Load adapter.....	10
2.4. T-Series cabinets.....	11
2.4.1. Altering the HF dispersion on T10 cabinets.....	11
2.4.2. Functionality of the cabinet's rigging mechanism.....	11
2.5. E7451/53 Touring cases.....	13
3. Preparing the setup.....	14
3.1. General.....	14
3.2. Inspections.....	14
3.3. Suspension of the Flying frame.....	15
3.3.1. Single pickpoint operation.....	15
3.3.2. Dual pickpoint operation.....	16
3.4. Secondary safety.....	17
3.5. Horizontal aiming and securing.....	18
4. T-Series arrays and assembly.....	19
4.1. Flown arrays.....	20
4.1.1. T10 Array.....	20
4.1.2. T-SUB Column.....	23
4.1.3. T-SUB/T10 Array.....	25
4.1.4. Setup of the E7451 Touring case assembly.....	27
4.2. T-Series ground stacks.....	32
4.2.1. T10 ground stack.....	32
4.2.2. T-SUB/T10 ground stack.....	34
4.2.3. T-SUB stacks.....	37
5. Checklist for the assembly of T-Series arrays.....	38
5.1. System and safety checks.....	38
5.1.1. Flown arrays.....	38
5.1.2. Ground stacks.....	38
5.1.3. Wiring.....	38
5.2. Hoisting and securing the array.....	39
6. Wind loads.....	40
7. Care and maintenance / Disposal.....	41
7.1. Transport / Storing.....	41
7.2. Visual and functional inspection.....	41
7.3. Disposal.....	41
EC Declaration of Conformity.....	42

1. Safety precautions

1.1. Intended use

The T-Series rigging components (Flying frame, Load adapter, Locking pins) must only be used in conjunction with d&b T-Series loudspeakers as described in this manual.

Installation and setup should only be carried out by qualified and authorized personnel observing the valid national Rules for the Prevention of Accidents (RPA).

It is the responsibility of the person installing the assembly to ensure that the suspension/fixing points are suitable for the intended use.

1.1.1. Load capacity/System safety

The Z5370 T Flying frame is designed to suspend a total system weight of 250 kg (550 lb) – SWL.

The rigging components allow arrays of up to 10 x T10 cabinets or a total system weight of 110 kg (242 lb) to be flown in any vertical splay angle configuration between the cabinets.

For this purpose the Flying frame must be freely suspended using appropriate steel wires or hoisting chains or using the d&b Z5147 Rota Clamp (single pickpoint operation). Any other type of suspension of the Flying frame is not allowed.

For arrays with a total system weight of more than 110 kg (242 lb) the load conditions within the array have to be checked using the d&b ArrayCalc calculator, which can be downloaded at www.dbaudio.com.

1.1.2. ArrayCalc / TI 385

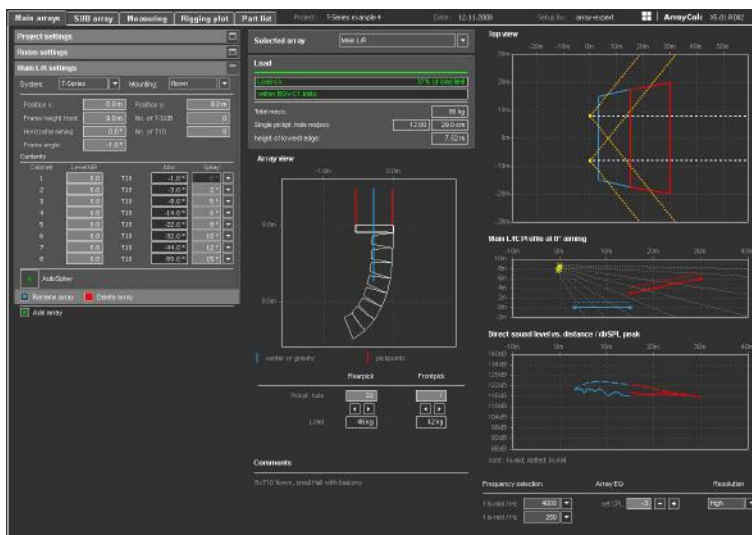

The use of ArrayCalc is described in "TI 385 J, Q and T-Series system design, d&b ArrayCalc" which is also supplied with the Z5370 T Flying frame.

This TI includes typical array configurations within the permitted load limits.

Carefully read this TI to become familiar with the operation and behaviour of ArrayCalc and in particular with the mechanical load conditions and limitations.

We also recommend you to attend the regularly hosted d&b T-Series training seminars. Further information regarding the d&b seminars can be requested directly from d&b audiotechnik sales partners.

1.2. Operational safety



During assembly pay attention to the possible risk of crushing. Wear suitable protective clothing.

Observe all instructions given on the rigging components (Flying frame, Load adapter) and the loudspeaker cabinets.

When chain hoists are in operation ensure that there is nobody directly underneath or in the vicinity of the load.

Do not under any circumstances climb on the array.

2. T-Series rigging concept

T-Series cabinets are mechanically connected to the T Flying frame and subsequent loudspeakers using the Front links attached to both sides of the cabinet front and the central Splay link at the rear of the cabinet.

All necessary rigging components are mounted to the cabinet and slide out when needed.

The T-SUB cabinets can also be attached to the T Flying frame either at the top of an array with subsequent T10 loudspeakers attached or as a column of T-SUBs.

2.1. Z5370 T Flying frame

The Z5370 T Flying frame is equipped and supplied with the following rigging components:

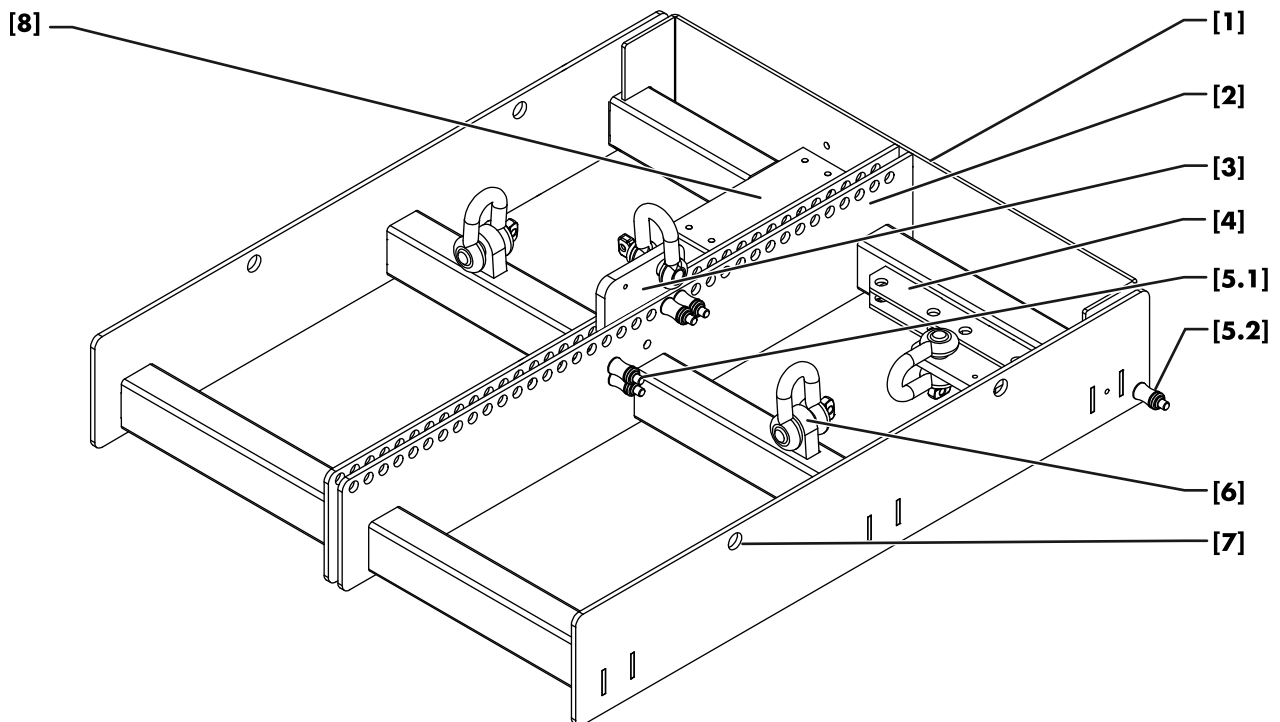

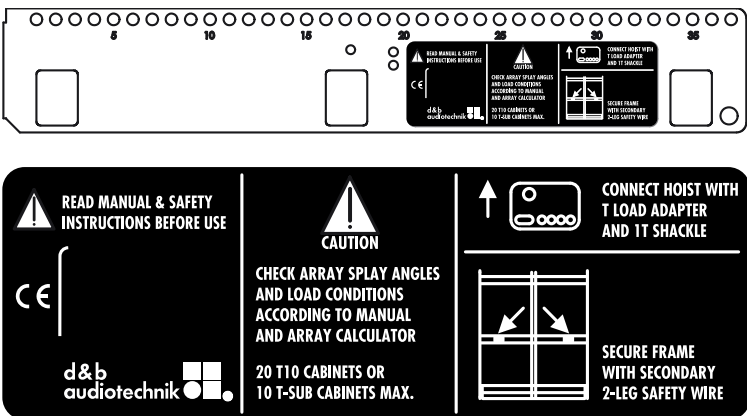

Fig. 1: Z5370 T Flying frame (rear view)

2.1.1. System components overview

Pos.	Component	Description									
[1]	Z5370 T Flying frame <div style="border: 1px solid black; padding: 5px; width: fit-content;"> <p>T Flying frame SWL: 250 kg (550 lb)  Z537000000001</p> </div>	<p>The Z5370 T Flying frame is designed to support arrays consisting of the following T-Series loudspeakers:</p> <table border="1"> <thead> <tr> <th>Code</th> <th>Type</th> <th>Weight incl. rigging comp.</th> </tr> </thead> <tbody> <tr> <td>Z0550</td> <td>T10</td> <td>11 kg (24 lb)</td> </tr> <tr> <td>Z0560</td> <td>T-SUB</td> <td>17 kg (37 lb)</td> </tr> </tbody> </table> <p>The weight of the Flying frame including all rigging components is 12 kg (26.5 lb).</p>	Code	Type	Weight incl. rigging comp.	Z0550	T10	11 kg (24 lb)	Z0560	T-SUB	17 kg (37 lb)
Code	Type	Weight incl. rigging comp.									
Z0550	T10	11 kg (24 lb)									
Z0560	T-SUB	17 kg (37 lb)									
[2]	Center bar	<p>Center bar of the Flying frame with hole index and user instruction label.</p>  <p>The main hole index at the top of the center bar provides a total of 37 holes numbered with an increment of five. Using the T Load adapters the Flying frame can be suspended from one or two pick points (please refer to section 3.3.1 Single pickpoint operation on page 15 and section 3.3.2 Dual pickpoint operation on page 16).</p>									
[3] [4]	T Load adapter Park position	<p>The Flying frame is supplied with two Load adapters. Each Load adapter is equipped with a 1 t shackle to allow single or dual pickpoint operation (please refer to section 2.3 T Load adapter on page 10). During transport the Load adapters should be stored in their park position [4].</p>									
[5.1] [5.2]	Locking pins Splay link Locking pins Front links	<p>Four Locking pins are provided with the Flying frame and are used to connect T-Series cabinets to the frame (please refer to section 2.2 T-Series Locking pins on page 9).</p>									
[6]	Safety point(s)	<p>The Flying frame is supplied with two safety points. Each safety point is equipped with a 1 t shackle to attach a secondary safety device (please refer to section 3.4 Secondary safety on page 17).</p>									
[7]	Additional holes	<p>Two additional holes 12.5 mm each are provided in the side bars of the frame. These can be used for horizontal aiming and securing the array against rotation (please refer to section 3.5 Horizontal aiming and securing on page 18).</p>									
[8]	Mounting plate	<p>The Flying frame is equipped with an additional mounting plate providing four M4 threaded inserts to accept inclinometers such as the Teqsas LAP-TEQ line array positioning tool.</p>									

2.1.2. Flying frame dimensions

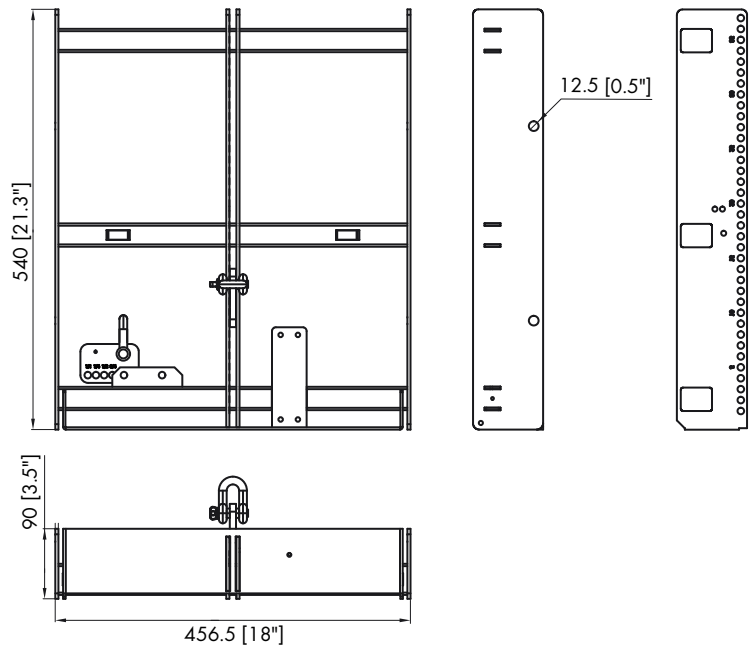

Fig. 2: Z5370 T Flying frame dimension in mm [inch]

Dimensions of the inclinometer mounting plate

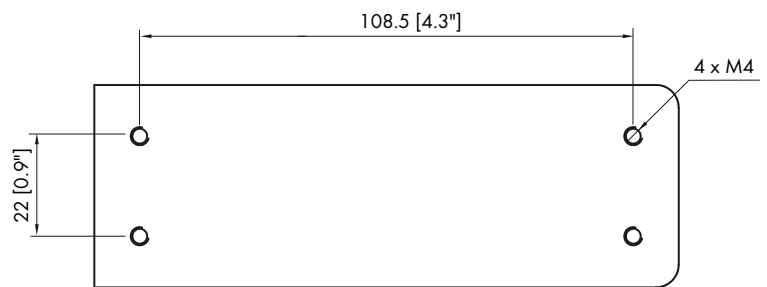

Fig. 3: Dimension of the mounting plate in mm [inch]

2.2. T-Series Locking pins



WARNING!

The steel wires between the locking pins and the cabinets and rigging components are not intended to carry any load.

The cabinet's weight must only be carried by the Front and Splay/Rear links in conjunction with the front and rear rigging strands of the loudspeaker cabinets and the Flying frame.

- Ensure all Locking pins are fully inserted and securely locked before lifting any load.

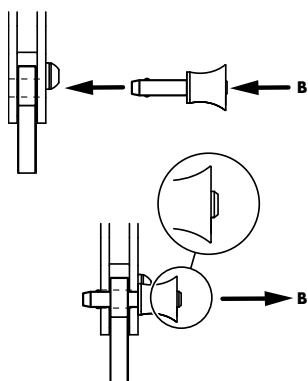

Fig. 4: Locking pins for the cabinet's Front links.

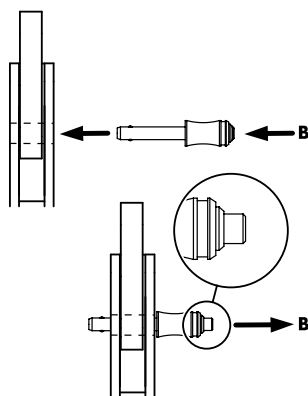

Fig. 5: Locking pins for the cabinet's Splay/Rear links the Flying frame and the Load adapters.

The T-Series cabinets are equipped with the following Locking pins:

- Two Locking pins 5 mm for the cabinet Front links.
- Two (T10) resp. three (T-SUB) Locking pins 6 mm for the Splay/Rear link on the central rear rigging strand.

The T Flying frame is equipped with the following Locking pins:

- Two Locking pins 6 mm [5.1] on the center bar of the frame to connect the Splay/Rear link of the first cabinet to the frame.
- One Locking pin 5 mm [5.2] on either side at the front of the frame to connect the Front links of the first cabinet to the frame.
- The two Load adapters supplied with the Flying frame are equipped with a pair of Locking pins 6 mm.

Assembly

The quick lock mechanism applies to all types of Locking pins listed above. To attach the Locking pin proceed as follows:

1. Press the button **[B]** to release the locking mechanism.
2. Insert the Locking pin through the respective link or socket until it is fixed in place.
3. Release the button to lock the pin.
4. Recheck the Locking pin is securely locked by briefly pulling the Locking pin towards you.

To release and remove the Locking pins follow the steps 1 to 3 in reversed order.



Fig. 6: T Load adapter

2.3. T Load adapter



WARNING!

- Before attaching the Load adapter check the 1 t shackle is properly fitted to the Load adapter and secured against loosening.
- Ensure the Load adapter is properly attached to the center bar of the frame and both Locking pins are fully inserted and locked securely before lifting the array.

The Load adapter is attached to the center bar of the Flying frame and fixed using its two Locking pins 6 mm.

In conjunction with the hole index of the center bar the Load adapter provides a 1/4-hole resolution.

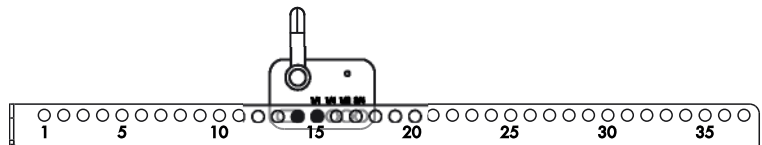

Fig. 7: T Flying frame hole index

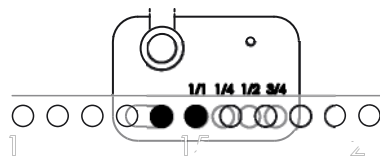
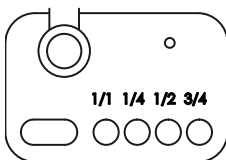

Fig. 8: Hole 14 (1/1)

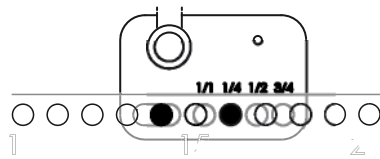

Fig. 9: Hole 14 + 1/4

Assembly

The Load adapter is equipped with four holes and one elongated hole.

The elongated hole always refers to the calculated main hole of the hole index.

To attach the Load adapter proceed as follows:

Example:

Hole 14 has been calculated using ArrayCalc.

1. Attach the Load adapter to the center bar of the frame with the elongated hole aligned to hole 14 of the hole index.
2. Insert and lock the first Locking pin to hole 14.
3. Move the Load adapter as long as the hole marked with 1/1 is in line with the next hole of the hole index.
4. Insert and lock the second Locking pin.

To achieve other hole values (e.g. 14 + 1/4) align the Load adapter to the desired hole value (1/4, 1/2 or 3/4 detents) and insert the second Locking pin.

2.4. T-Series cabinets

2.4.1. Altering the HF dispersion on T10 cabinets

When setting up T-Series arrays and ground stacks set the T10 cabinets to line source mode.

Swapping between point and line source setups is performed by simply rotating the horn by 90°. The horn is easily accessible from outside of the cabinet and can be rotated without any tools or removal of the front grill.

This is achieved through apertures on the cabinet sides by a mechanism that provides detents at both the line and point source positions.

The line source mode is indicated by a label on the horn marked with LINE as shown in the picture below.

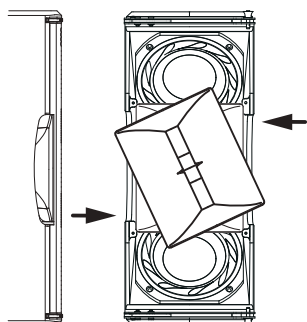

Fig. 10: Rotating the horn
(shown without front grill for better illustration)



2.4.2. Functionality of the cabinet's rigging mechanism

Front link mechanism

The Front link mechanism applies to both the T10 and the T-SUB cabinets.

- Slide out the Front link until it is fixed in place.



Splay/Rear link mechanism

T10

- Release both Locking pins and fold out the Splay link.

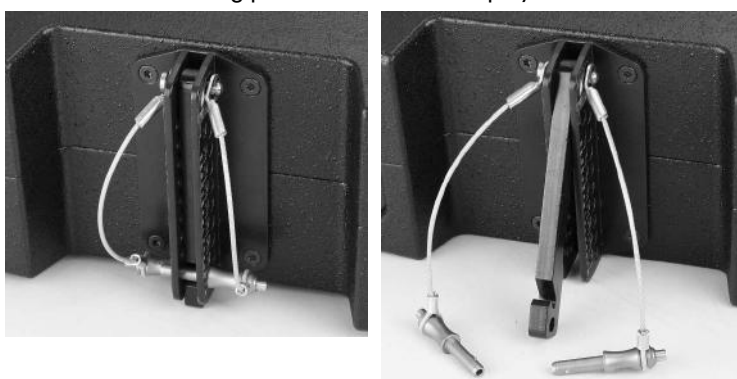

T-SUB

- Release the Locking pin and slide out the Rear link up to its stop position.
- Insert the Locking pin to fix the Rear link in place.



Preset play angles on T10 cabinets

The play angles between T10 cabinets can be set in the range from 0° to 15° in 1° steps.

The play angles are set at the central rear rigging strands of the T10 cabinets.



Interconnecting the cabinets

Both the T10 and T-SUB cabinets are interconnected with their Front links on both sides of the cabinet's front and with the Splay/Rear links on the center rigging strand at the cabinet's rear.

Front links

Once the Front links are fit into the respective track of the next cabinet, the cabinets are interconnected by inserting the Locking pins to both sides of the cabinet.



Splay / Rear links

T10

The Splay links of the T10 cabinets are folded out and hooked into the preset Locking pin on the rear rigging strand of the next cabinet.

Once the Splay link is hooked in, the second Locking pin must be inserted. The second Locking pin acts as a "safety pin" to secure the Splay link from possible hooking off and to fix the set splay angle.

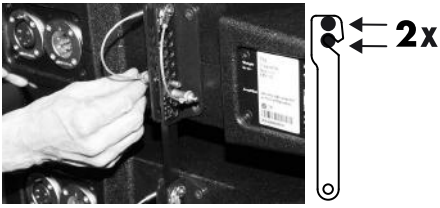

T-SUB

The Rear link of the T-SUB cabinets are fit into the rear rigging strand of the next cabinet and fixed in position with the Locking pin of the Rear link.

Once the Rear link is fit into the rear rigging strand of the next cabinet the Rear link is fixed in place using the two Locking pins of the next cabinet.

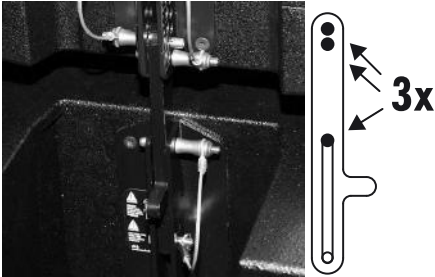

2.5. E7451/53 Touring cases

E7451 Touring case 4 x T10 assembly

The E7451 Touring case is intended to store and transport 4 x T10 cabinets which are interconnected by their Front links. It also allows you to connect the assembly to the Flying frame or below T-SUBs within a mixed T-SUB/T10 array in one procedure.

The assembly instructions are given in section 4.1.4 Setup of the E7451 Touring case assembly starting from page 27.

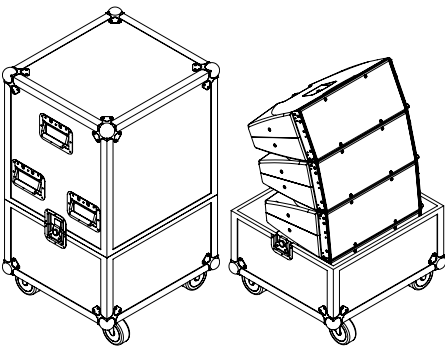

E7453 Touring case 2 x T-SUB assembly

The E7453 Touring case is intended to store and transport 2 x T-SUB cabinets. If the two T-SUB cabinets are interconnected by their Front and Rear links it also allows you to connect the assembly to the Flying frame in one procedure to build T-SUB columns or mixed T-SUB/T10 arrays.

The assembly follows the instructions given in section 4.1.2 T-SUB Column starting from page 23.

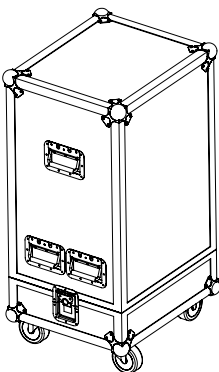

3. Preparing the setup

3.1. General

Check the acoustical and mechanical setup using the ArrayCalc array calculator and prepare enough printouts for each array.

The plan enables the riggers to set up the suspension points, the securing points and the chain hoists.

When on site first:

- clear the working areas,
- check that the hoists are exactly in the specified position,
- the chains are not twisted,
- there is enough space to set up and lift the array.

3.2. Inspections

Before setup carry out a visual inspection of all system components for faults. This also includes the loudspeaker and in particular the rigging parts of the cabinets (Front and Splay links).

Damaged components must be withdrawn from use immediately. Please follow the instructions in section 7. Care and maintenance / Disposal on page 41 of this manual.

3.3. Suspension of the Flying frame



WARNING!

The working load limits of the chain hoists and their suspension points has to be high enough to carry the total system weight.

As during dual pickpoint operation the motors might not always be synchronized each of the suspension points must be able to carry the total system weight.

The Flying frame must be freely suspended using appropriate steel wires or hoisting chains or using the d&b Z5147 Rota Clamp (Single pickpoint operation). Any other type of suspension of the Flying frame is not allowed.

The suspension of the Flying frame is carried out using one or two Load adapter(s), depending on the chosen type of suspension (Single or Dual pickpoint operation).

Note:

The shown hoist connector chains in the graphics below are not supplied with the T Flying frame

For this purpose the Z5155 Q Hoist connector chain can be used. Its length of 52 cm (20.5") allows enough space for the hang of most 1 t motor chain containers.

3.3.1. Single pickpoint operation

In "Single pickpoint operation" the position of the Load adapter defines the vertical aiming of the entire array.

The corresponding hole position is calculated using ArrayCalc (Fig. 11).

Attaching the Load adapter

1. Place the Flying frame on the ground with the hole index facing upwards.
2. Choose the appropriate hole position in the center bar of the frame according to the ArrayCalc calculation and attach the Load adapter correspondingly.
3. Connect the hoist connector chain to the shackle of the Load adapter.

Note:

Alternatively the d&b Z5147 Rota Clamp can be attached the Load adapter to allow the attachment of the Flying frame to overhead bars or trusses with a tube diameter up to 51 mm (2").

Attaching the cable pick

In "Single pickpoint Operation" do not attach the cable pick to the frame to not affect the total vertical aiming of the entire array by the cable load.

We recommend to attach the cable pick to the hook of the hoisting motor.



Fig. 11: ArrayCalc Hole position for Single pickpoint operation

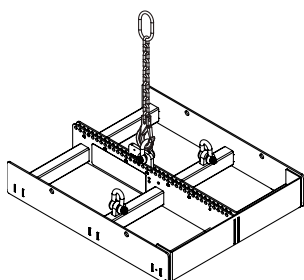

Fig. 12: Single pickpoint operation

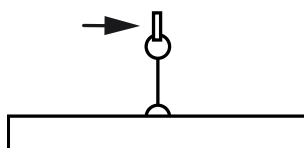

Fig. 13: Cable pick Single pickpoint operation



Fig. 14: ArrayCalc Hole positions for Dual pickpoint operation

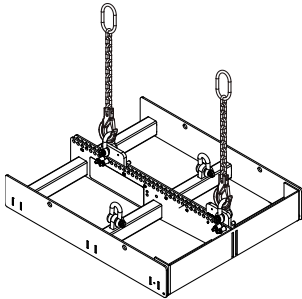

Fig. 15: Dual pickpoint operation



Fig. 16: Cable pick Dual pickpoint operation

3.3.2. Dual pickpoint operation

With "Dual pickpoint operation" the vertical aiming of the array is set by trimming the hoist motors after the array has been fully assembled and lifted to its operating position.

The corresponding hole positions are calculated using ArrayCalc (Fig. 14).

Attaching the Load adapter(s)

1. Place the Flying frame on the ground with the hole index facing upwards.
2. Choose the appropriate hole positions for the Frontpick and Rearpick in the center bar of the frame according to the ArrayCalc calculation and attach the Load adapters correspondingly.
3. Connect the hoist connector chain to the shackle of the Load adapter.

Attaching the cable pick

We recommend to attach the cable pick to the hook of the hoisting motor of the Rearpick.

3.4. Secondary safety



WARNING!

The secondary safety suspension must be independent of the primary suspension points and capable of carrying the total system weight.

- Attach the additional safety device in a way that the array is caught by the safety device without any significant drop and swing in the event that the primary suspension fails.

Secondary safety at the Flying frame

The Flying frame is equipped with two safety points [1.2] fitted with two 1 t shackles to accept a secondary safety device such as a 2-leg safety wire or safety chains.

Note: The safety devices shown in the pictures below are not part of the delivery.

Assembly

Ensure the two 1 t shackles are properly fitted to the safety points of the Flying frame.

2-leg safety wire

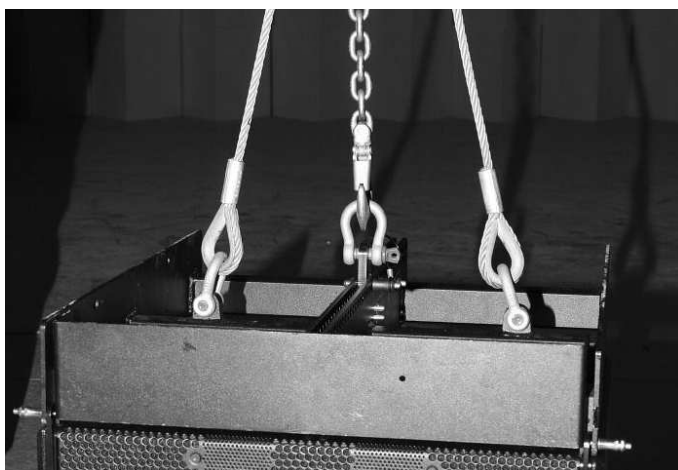

Safety chains

When using chains as secondary safety device ensure the chains are not twisted and the hooks are in the right direction as shown in the picture below.

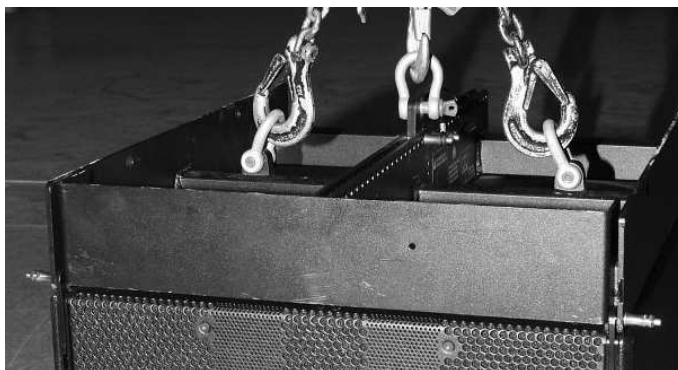

3.5. Horizontal aiming and securing



WARNING!

If the system is used in an open-air environment the influence of wind has to be taken into account. The protection against rotation and swing has to withstand higher forces. Refer to section 6. Wind loads on page 40.

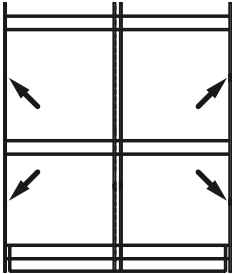

Fig. 17: Additional fixing points of the frame for horizontal aiming and protection against rotation and swing

After the array has been lifted to its operating position the horizontal aiming has to be set and the array should be secured against rotation and swing.

The protection can be attached to the additional holes at the side bars of the Flying frame - Fig. 17.

4. T-Series arrays and assembly



WARNING!

Due to the compact and lightweight T-Series cabinets and rigging components the assembly may be carried out by a single person.

However, during assembly or dismantling the array could suddenly move or swing.

- Therefore carry out the setup with two persons with one person securing the Array.
- Ensure no other person remains in the vicinity of the assembly area.

T-Series loudspeakers and T Flying frames can be assembled in the following ways.

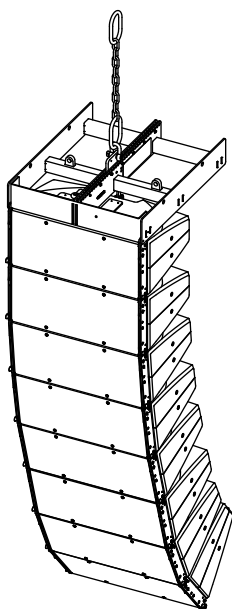

T10 Array
(Refer to section 4.1.1
starting from page 20)

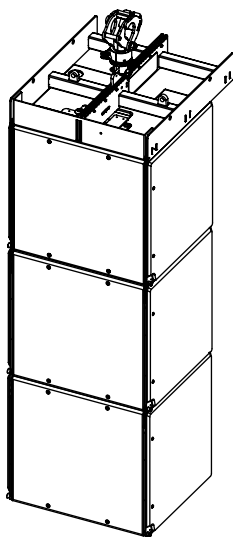

T-SUB column
(Refer to section 4.1.2
starting from page 23)

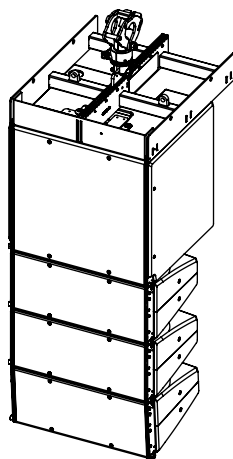

T-SUB/T10 Array
(Refer to section 4.1.3
starting from page 25)

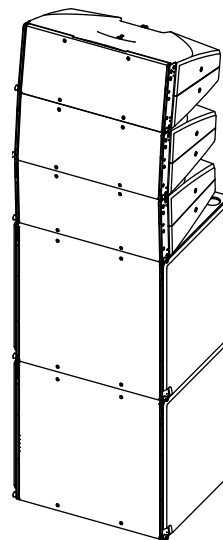

T Ground stacks
(Refer to section 4.2
starting from page 32)

4.1. Flown arrays

4.1.1. T10 Array

Limitation

A maximum of 20 x T10 cabinets are allowed to be flown.

Preparations

- Prepare the flying cables and link cables according to the number of amplifier channels and cabinets used.
- Ensure the HF sections of the T10 cabinets to be used are set to Line source.

Order of assembly

1. Suspend the Flying frame

- Suspend the Flying frame according to the chosen type of suspension as described in section 3.3 on page 15.
- Release the two Locking pins at the front of the frame.

2. Prepare the first T10 cabinet

- Prepare the Front and Splay links of the first T10 cabinet as described in section 2.4 on page 11.

3. Attach the Flying frame to the first T10 cabinet

- Lower the frame onto the cabinet until the Front links fit into the slots at the front of the frame.
- Insert and lock the frame's Locking pins through the Front links of the T10 cabinet on both sides.



- Release the upper Locking pin at the support point for the Splay link on the center bar of the frame.
- Fold up the Splay link of the cabinet into the track of the frame's center bar until the link hooks over the Locking pin. To achieve this you may first have to lower the frame slightly more.

- Lift the frame by hand until the Splay link hooks into the Locking pin and keep holding the frame in this position.
- Insert the second Locking pin (safety pin) to secure the Splay link.
- Lift the frame to a suitable working height to add the next cabinet.

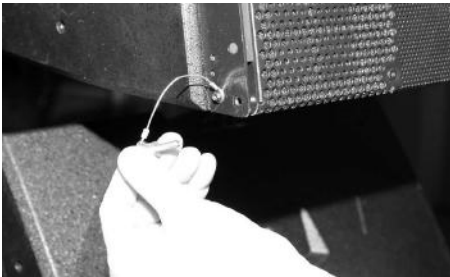

4. Add further T10 cabinets

- Preselect the desired splay angle on the upper cabinet.
- Slide and fold out the Front and Splay links of the next cabinet.
- On the rear hook the Splay link of the next cabinet over the preset Locking pin of the upper cabinet.
- Lower the cabinet to enable the second Locking pin to be inserted.
- Insert the second Locking pin (safety pin) to secure the Splay link of the cabinet.
- Release the Locking pins at the front of the upper T10 cabinet.
- Raise the bottom cabinet.
- Align the cabinets so as to enable the Locking pins to be inserted through the Front links of the bottom cabinet.
- Insert and lock the Locking pins on both sides.
- To add further cabinets proceed in the same manner until the assembly is completed.

5. Rig the cabling

- Connect the flying cables and link cables according to the number of amplifier channels and cabinets used.
- Attach the cable pick depending on the chosen type of suspension (Single or Dual pickpoint operation setup) as described in section 3.3 Suspension of the Flying frame on page 15.

6. Check the assembly

- Before hoisting the array to its operating position recheck the actual status of the assembly according to the checklist given in section 5. Checklist for the assembly of T-Series arrays on page 38.

7. Derig the array

- To lower the array and dismantle it, follow the assembly instructions in reverse order. The same safety instructions apply.

4.1.2. T-SUB Column

Limitation

A maximum of 10 x T-SUB cabinets are allowed to be flown as a SUB column.

Preparations

Prepare the flying cables and link cables according to the number of amplifier channels and cabinets used.

Order of assembly

1. Suspend the Flying frame

- Suspend the Flying frame according to the chosen type of suspension as described in section 3.3 on page 15.
- Release the two Locking pins at the front of the frame.

2. Prepare the first T-SUB cabinet

- Prepare the Front links of the first T-SUB cabinet as described in section 2.4 on page 11.

3. Attach the Flying frame to the first T-SUB cabinet

- Lower the frame onto the cabinet until the Front links fit into the slots at the front of the frame.
- Insert and lock the frame's Locking pins on both sides.



- Release the two Locking pins at the support point for the Rear link on the track of the frame's center bar.
- Release the Locking pin of the Rear link of the T-SUB cabinet.
- Slide out the Rear link up to its stop position into the track of the frame's center bar.
- Insert the Locking pin of the Rear link at the T-SUB cabinet.
- Insert the two Locking pins at the support point for the Rear link on the track of the frame's center bar.



4. Add the next T-SUB cabinet

- Lift the assembly to a suitable height to add the next cabinet.
- Place the next T-SUB on the ground.
- Lower the assembly onto the cabinet until the rubber feet fit into the recessed areas on the top panel of the bottom cabinet.
- Release the Locking pins at the front of the upper cabinet.
- Slide out the Front links of the bottom cabinet.
- Insert the Locking pins for the Front links on both sides.
- Release the Locking pins on the rear rigging strand of the upper cabinet and the Locking pin of the Rear link of the bottom cabinet.
- Slide out the Rear link up to its stop position into the rigging strand of the upper cabinet.
- Insert the Locking pin for the Rear link.
- Insert the two Locking pins on the rear rigging strand of the upper cabinet.
- To add further cabinets, proceed in the same manner until the assembly is completed.

5. Rig the cabling

- Connect the flying cables and link cables according to the number of amplifier channels and cabinets used.
- Attach the cable pick depending on the chosen type of suspension (Single or Dual pickpoint operation setup) as described in section 3.3 Suspension of the Flying frame on page 15.

6. Check the assembly

- Before hoisting the array to its operating position recheck the actual status of the assembly according to the checklist given in section 5. Checklist for the assembly of T-Series arrays on page 38.

7. Derig the array

- To lower the array and dismantle it, follow the assembly instructions in reverse order. The same safety instructions apply.

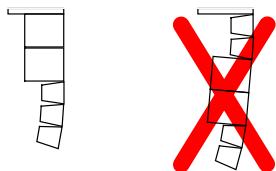

4.1.3. T-SUB/T10 Array



WARNING!

For a mixed array consisting of T-SUB and T10 cabinets, the T-SUB cabinets must always be positioned at the top of the array.

Preparations

- Prepare the flying cables and link cables according to the number of amplifier channels and cabinets used.
- Ensure the HF sections of the T10 cabinets to be used are set to Line source.

Order of assembly

1. Suspend the Flying frame

- Suspend the Flying frame according to the chosen type of suspension as described in section 3.3 on page 15.
- Release the two Locking pins at the front of the frame.

2. Attach the T-SUB cabinets

Assembly of the T-SUB cabinets at the top of the array is carried out in the same manner as described in the previous section 4.1.2 T-SUB Column starting from page 23.

3. Prepare the first T10 cabinet

- Prepare the Front and Splay links of the first T10 cabinet as described in section 2.4 on page 11.

4. Attach the first T10 cabinet

- Release the upper Locking pin on the rear rigging strand of the last T-SUB cabinet.
- On the rear hook the Splay link over the Locking pin of the T-SUB cabinet.

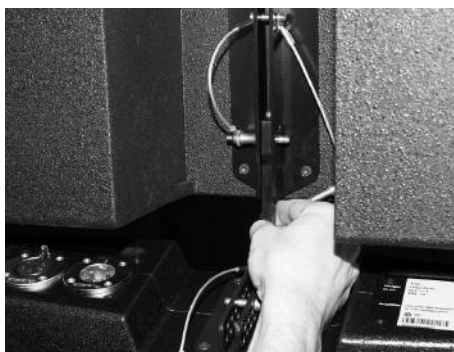

- Lower the cabinet to enable the second Locking pin to be inserted.
- Insert the second Locking pin (safety pin) to secure the Splay link of the cabinet.



- Release the Locking pins at the front of the the T-SUB cabinet.
- Raise the bottom cabinet.
- Align the cabinets so as to enable the Locking pins to be inserted through the Front links of the T10 cabinet.
- Insert and lock the Locking pins on both sides.

5. Add further T10 cabinets

Assembly of further T10 cabinets is carried out in the same manner as described in section 4.1.1 starting from step 4 Add further T10 cabinets on page 21.

6. Rig the cabling

- Connect the flying cables and link cables according to the number of amplifier channels and cabinets used.
- Attach the cable pick depending on the chosen type of suspension (Single or Dual pickpoint operation setup) as described in section 3.3 Suspension of the Flying frame on page 15.

7. Check the assembly

- Before hoisting the array to its operating position recheck the actual status of the assembly according to the checklist given in section 5. Checklist for the assembly of T-Series arrays on page 38.

8. Derig the array

- To lower the array and dismantle it, follow the assembly instructions in reverse order. The same safety instructions apply.

4.1.4. Setup of the E7451 Touring case assembly

E7451 Touring case 4 x T10 assembly



WARNING!

The total center of gravity of the E7451 Touring case assembly will shift towards the front during assembly.

To prevent the case from moving and tipping over during setup and/or dismantling we strongly recommend you to proceed as follows:

- Carry out the setup with two persons with one person securing the case.
- Ensure no other person remains in the vicinity of the assembly area.

Preparations

- Prepare the flying cables and link cables according to the number of amplifier channels and cabinets used.

Order of assembly

1. Suspend the Flying frame

- Suspend the Flying frame according to the chosen type of suspension as described in section 3.3 on page 15.
- Release the two Locking pins at the front of the frame.

2. Prepare the T10 cabinets in the touring case

- Bring the Touring case into position.
- Slide out the Front links of the upper cabinet.
- Set the splay angles between the cabinets according to your ArrayCalc simulation as follows:
 - Starting with the top cabinet of the assembly first preset the desired splay angle by inserting one Locking pin.
 - Fold up the Splay link of the cabinet below into the rear rigging strand of the upper cabinet.
 - Lift the upper cabinet by hand until the hook of the Splay link has hooked into the preset Locking pin.
 - Insert the second Locking pin (safety pin) to secure the Splay link.
- Proceed in the same manner until all splay angles of the assembly are set.

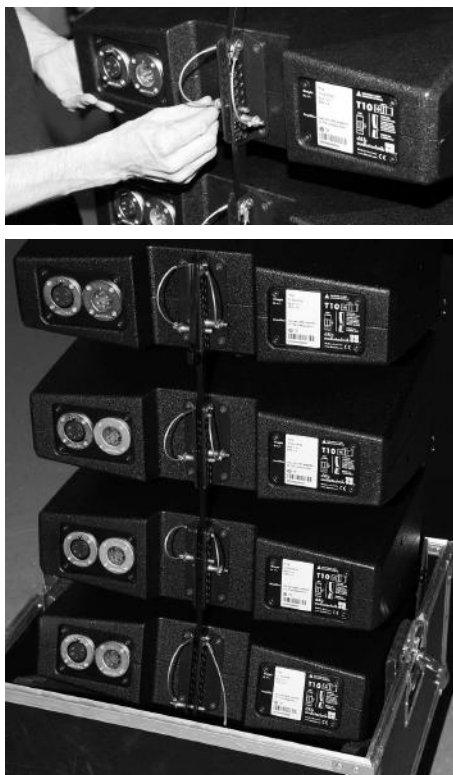



3. Attach the Flying frame to the assembly

- Lower the frame onto the assembly until the Front links fit into the slots at the front of the frame while a second person secures the case against moving and tipping over.
- Insert and lock the frame's Locking pins through the Front links of the T10 cabinet on both sides.



- Release the upper Locking pin at the support point for the Splay link on the center bar of the frame.
- Fold up the Splay link of the cabinet into the track of the frame's center bar until the link hooks over the Locking pin. To achieve this you may first have to lower the frame slightly more.

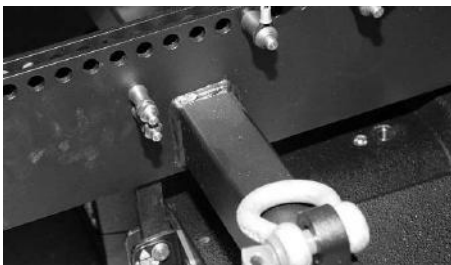

- Lift the frame by hand until the Splay link hooks into the Locking pin and keep holding the frame in this position.
- Insert the second Locking pin (safety pin) to secure the Splay link.
- Lift the assembly out of the case to a suitable working height to add the next assembly of T10 cabinets.

4. Attach the next assembly

- Place the next Touring case assembly.
- Set and secure the splay angles between the cabinets as described in the previous step 2 on page 27.
- Slide out the Front links of the upper cabinet.
- Release the Locking pins at the front of the bottom cabinet of the previously attached assembly.
- Lower the upper assembly until the Front links fit into the slots at the front of the upper T10 cabinet while a second person secures the case against moving and tipping over.
- Insert and lock the Locking pins through the Front links of the T10 cabinet on both sides.
- Slowly lift the entire assembly out of the bottom tray of the case.

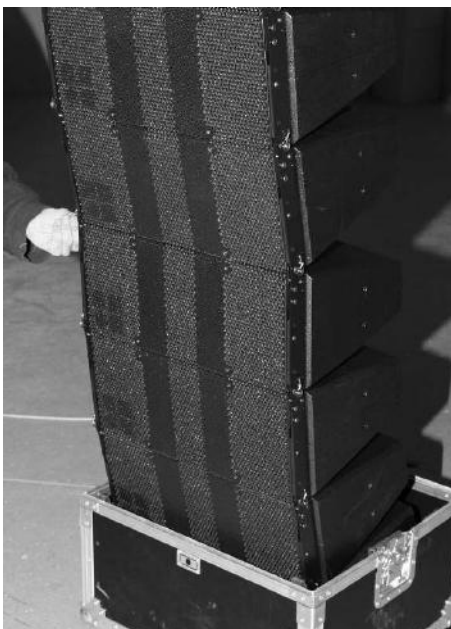



- On the rear of the assembly preset the desired splay angle at the rear rigging strand of the bottom cabinet of the upper assembly.



- Raise the bottom assembly and hook the Splay link over the preset Locking pin.



- Slightly lower the bottom assembly to enable the second Locking pin (safety pin) to be inserted.
- Insert the second Locking pin to secure the Splay link of the cabinet.
- To add further assemblies proceed in the same manner until the array is completed.

5. Rig the cabling

- Connect the flying cables and link cables according to the number of amplifier channels and cabinets used.
- Attach the cable pick depending on the chosen type of suspension (Single or Dual pickpoint operation setup) as described in section 3.3 Suspension of the Flying frame on page 15.

6. Check the assembly

- Before hoisting the array to its operating position recheck the actual status of the assembly according to the checklist given in section 5. Checklist for the assembly of T-Series arrays on page 38.

7. Derig the array



WARNING!

Dismantling the assembly of 4 x T10 cabinets while releasing the Splay link of the upper cabinet and lower the assembly the entire array could move or swing towards the front in a sudden.

Therefore we strongly recommend you to proceed as follows:

- Ensure no other person remains in the vicinity of the assembly area.
- Always secure the array by a second person to safely lower the array and dismantle it.



- Lower the array to a suitable working height.
- On the rear lift the bottom assembly until the second Locking pin (securing pin) of the Splay link can be released.
- Lift the assembly further more until the Splay link can be hooked off.

- Carefully lower the assembly while a second person renders support to secure the entire array against uncontrolled movement and swing.

- Place the bottom tray of the E7451 Touring case below the array.
- Release all safety pins (second Locking pin) at the rear of the bottom four cabinets before lower them into tray of the case.
- Lower the assembly into the tray while a second person renders support to secure the case against uncontrolled movement or tipping over.
- Before releasing the two Locking pins of the Front links which connect the bottom assembly with the array, a second person renders support to secure the entire array against uncontrolled movement and swing.
- Release the Locking pins of the Front links and lift the array slightly.
- Release all Locking pins on the rear rigging strand and fold down the Splay links so that the cabinets are on block.
- Proceed in the same manner until the array is completely dismantled.



E7451 Touring case assembly below T-SUB cabinets

The E7451 Touring case assembly can also be attached below T-SUB cabinets within a mixed T-SUB/T10 array with T-SUB cabinets at the top of the array (Please refer to section 4.1.3. T-SUB/T10 Array on page 25).

To attach the assembly below T-SUB cabinets proceed in the same manner as described in the previous section 4.1.4 following step 4 on page 28. The same safety instructions apply.

To lower the array and dismantle it, refer to the previous section 4.1.4 following step 7 on page 30. The same safety instructions apply.

4.2. T-Series ground stacks



WARNING!

Always secure ground stacked setups against movement and possible tipping over.

4.2.1. T10 ground stack

Limitation

A maximum of 6 x T10 cabinets with the T Flying frame serving as ground support are allowed to be set up as ground stack.

Preparations

- Prepare the cables and link cables according to the number of amplifier channels and cabinets used.
- Ensure the HF sections of the T10 cabinets to be used are set to Line source.

Order of assembly

1. Prepare the Flying frame

- Place the Flying frame on the ground with the hole index facing downwards.
- Release the two Locking pins at the front of the frame.



2. Prepare the first T10 cabinet

- Prepare the Front and Splay links of the first T10 cabinet as described in section 2.4 on page 11.

3. Attach the first T10 cabinet

- With the Front links facing downwards attach the cabinet to the slots at the front of the frame.
- Insert and lock the frame's Locking pins on both sides.



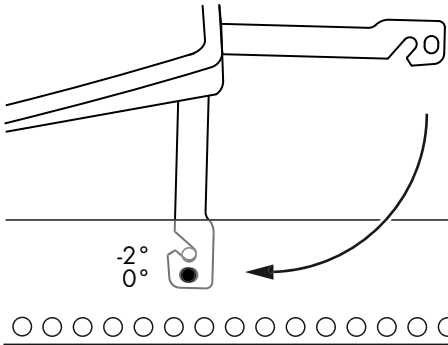

4. Set vertical aiming of the first T10 cabinet

The two supporting holes on the Flying frame's center bar allow the first T10 cabinet to be set to a fixed vertical aiming of -2° or 0° .

In this case the hole (drill) of the cabinet's Splay link is used.

Using the upper hole of the supporting holes allows for a vertical aiming of -2° the bottom hole for 0° .

- Fold out and insert the Splay link of the cabinet into the track of the center bar of the frame and align the hole of the Splay link with the desired supporting hole of the frame.
- Insert one of the frame's Locking pins to fix the Splay link in place.
- The second Locking pin is not required and should be stored in the remaining hole.

5. Add further T10 cabinets

- Preselect the desired splay angle on the rear rigging strand of the bottom cabinet.
- Release the Locking pins at the front of the bottom cabinet.
- Prepare the next cabinet.
- With the Front links facing downwards attach the cabinet to the slots at the front of the bottom cabinet.
- Insert and lock the Locking pins of the Front links on both sides.
- Fold out the Splay link of the cabinet and connect it to the cabinet below as follows:
 - Lower the back of the cabinet until the Splay link hooks over the preset Locking pin.
 - Raise the back of the cabinet until the Splay link is completely hooked into the Locking pin.
 - Insert the second Locking pin (safety pin) to fix the desired splay angle.

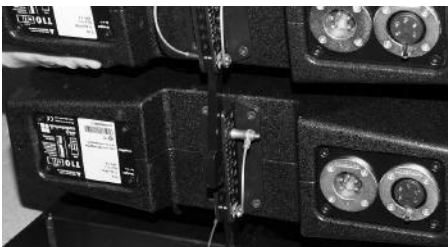

To attach further T10 cabinets, proceed in the same manner until the assembly is completed.

Note: The two Locking pins at the top cabinet of the stack are not used. They should be stored in two of the remaining holes on the rear rigging strand.

6. Rig the cabling

- Connect the cables and link cables according to the number of amplifier channels and cabinets used.

7. Check the assembly

- Recheck the assembly according to the checklist given in section 5. Checklist for the assembly of T-Series arrays on page 38.

8. Derig the ground stack

- To dismantle the ground stack, follow the assembly instructions in reverse order. The same safety instructions apply.

4.2.2. T-SUB/T10 ground stack

Limitation

A maximum of 3 x T10 cabinets on top of maximum 2 x T-SUB cabinets serving as ground support are allowed to be set up as ground stack.

Preparations

- Prepare the cables and link cables according to the number of amplifier channels and cabinets used.
- Ensure the HF sections of the T10 cabinets to be used are set to Line source.

Order of assembly

1. Stack the two T-SUB cabinets

- Interconnect the cabinets with their Front and Rear links.

2. Attach the first T10 cabinet

- Slide out the Front links of the T-SUB cabinet.
- Release the Locking pins at the front of the T10 cabinet.
- Attach the T10 cabinet to the Front links of the T-SUB cabinet.
- Insert and lock the Locking pins for the Front links on both sides.



3. Set vertical aiming of the first T10 cabinet

The vertical aiming of the first T10 cabinet connected to the T-SUB depends on the chosen hole of the T-SUB's Rear link.

Using the upper hole of the Rear link allows for angles of -2° or -1° .

Using the bottom hole allows for angles of 0° , $+1^\circ$, $+2^\circ$, $+3^\circ$, $+4^\circ$ or $+6^\circ$ corresponding to the scale on the T10 rear rigging strand.

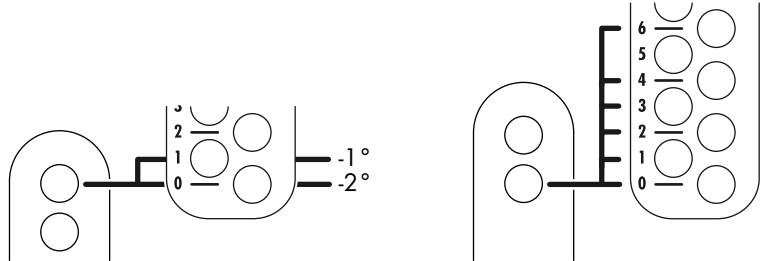

To apply the angles proceed as follows:

- On the rear release the Locking pins of the Splay link of the T10 cabinet and fold up the Splay link.
- Release the Locking pin of the Rear link of the T-SUB.
- Slide out the Rear link up to its stop position.
- Insert and lock the Locking pin for the Rear link on the T-SUB cabinet.
- Align the T10 cabinet to the desired angle as shown in the graphic above.
- Insert the Locking pin for the Rear link on the T10 cabinet.

Note:

The second Locking pin is not used. It should be stored in one of the remaining holes on the rear rigging strand.

4. Add further T10 cabinets

- Slide out the Front links on the currently attached T10 cabinet.
- Prepare the next cabinet and preselect the desired splay angle on the rear rigging strand of the next T10 cabinet.
- Release the Locking pins at the front of the cabinet.
- Attach the cabinet to the Front links of the bottom cabinet.
- Insert and lock the Locking pins for the Front links on both sides.



- On the rear fold up the Splay link of the bottom cabinet and connect it to the upper cabinet as follows:
 - Lower the back of the upper cabinet until the Splay link hooks over the preset Locking pin.
 - Raise the back of the cabinet until the Splay link is completely hooked into the Locking pin.
 - Insert the second Locking pin (safety pin) to secure the Splay link.
- To attach further T10 cabinets, proceed in the same manner until the assembly is completed.

5. Rig the cabling

Connect the cables and link cables according to the number of amplifier channels and cabinets used.

6. Check the assembly

Recheck the assembly according to the checklist given in section 5. Checklist for the assembly of T-Series arrays on page 38.

7. Derig the ground stack



WARNING!

The total center of gravity of the T-SUB/T10 ground stack is located close to the front of the stack.

To prevent the stack from tipping over while dismantling it we recommend you to proceed as follows:

- Standing in front of the ground stack first release the Locking pins of the Splay link of the first T10 cabinet and fold out the Splay link.



- Release the Locking pins for the Front links on both sides while holding the cabinet.
- Remove the cabinet.
- Proceed in the same manner until all T10 cabinets are dismantled.



4.2.3. T-SUB stacks

Conventional T-SUB stacks are set up in the same manner as described in the previous section 4.2.2 following step 1 on page 34. For conventional ground stacks of T-SUB cabinets we also recommend connecting the cabinets using their Rear links.



5. Checklist for the assembly of T-Series arrays

5.1. System and safety checks

5.1.1. Flown arrays

Before hoisting the array to its operating position recheck the actual status of the assembly as follows:

- Check the attachment of the Load adapter(s) to the Flying frame and ensure all Locking pins are properly locked.
- Check the attachment of the secondary safety device at the Flying frame (refer to section 3.4 on page 17).
- Check the attachment of the Flying frame to the first cabinet (T10 or T-SUB Front and Splay/Rear links) and ensure all Locking pins are properly locked.
- Check the attachment of all Front links on both sides of the cabinets and ensure all Locking pins are properly locked.
- Check the splay angles.
- Check the attachment of the Splay/Rear links at the rear of the cabinets and ensure all Locking pins are properly locked.
- In "Single pickpoint operation" check the desired total vertical aiming of the entire array using a inclinometer.

5.1.2. Ground stacks

- Check the attachment of all Front links on both sides of the cabinets and ensure all Locking pins are properly locked.
- Check the splay angles.
- Check the attachment of the Splay/Rear links at the rear of the cabinets and ensure all Locking pins are properly locked.

5.1.3. Wiring

- Check the wiring.
If the amplifiers are already wired and powered on, use their System check function or channel mute switches and a test signal to check the correct functioning and routing of all channels and cabinets.

5.2. Hoisting and securing the array

When all the mechanical adjustments, system checks and safety checks have been made the array can be hoisted up to its operating position.

When hoisting the array, ensure that the loudspeaker cables do not get caught anywhere. The cables can be strapped together with the motor cable to form a loom while the system is hoisted.

The chain hoist motors must raise the system slowly and evenly so that it does not swing or move from side to side during hoisting.

When the array is in its final operating position the secondary safety must be applied. A detailed description is given in section 3.4 Secondary safety on page 17.

6. Wind loads

When planning an open-air event it is essential to obtain current weather and wind information.

When loudspeaker arrays are flown in an open-air environment, possible wind effects must be taken into account. Wind load produces additional dynamic forces acting on the rigging components and the suspension, which may lead to a dangerous situation.

If according to the forecast wind forces higher than 5 bft are possible, the following actions have to be taken:

- The actual on-site wind speed has to be monitored permanently. Be aware that wind speed typically increases with height above ground.
- Suspension and securing points of the array should be designed to support double the static load in order to withstand any additional dynamic forces.



WARNING!

Flying loudspeakers overhead at wind forces higher than 6 bft is not recommended.

If the wind force exceeds 8 bft there is a risk of mechanical damage to the components which may lead to a dangerous situation for persons in the vicinity of the flown array.

- Stop the event and make sure that no person remains in the vicinity of the array.
- Lower and secure the array.

The following wind speed scale according to Beaufort provides an impression of the effects of the different wind forces (bft).

bft	knots	km/h	mph	Description	Effects on land
0	0-1	0-1	0-1	Calm	Smoke rises vertically.
1	1-3	1-5	1-3	Light Air	Direction of wind shown by smoke drift, but not by wind vanes.
2	4-6	6-11	4-7	Light breeze	Wind felt on face; leaves rustle; ordinary vanes moved by wind.
3	7-10	12-19	8-12	Gentle breeze	Leaves and small twigs in constant motion; wind extends light flag.
4	11-16	20-28	13-18	Moderate breeze	Raises dust and loose paper; small branches are moved.
5	17-21	29-38	19-24	Fresh breeze	Small trees in leaf begin to sway; crested wavelets form on inland waters.
6	22-27	39-49	25-31	Strong breeze	Large branches in motion; whistling heard in telegraph wires; umbrellas used with difficulty.
7	28-33	50-61	32-38	Near gale	Whole trees in motion; inconvenience felt when walking against the wind.
8	34-40	62-74	39-46	Gale	Breaks twigs off trees; generally impedes progress.
9	41-47	75-88	47-54	Severe gale	Slight structural damage occurs (chimney-pots and slates removed).
10	48-55	89-102	55-63	Storm	Trees uprooted; considerable structural damage occurs.
11	56-63	102-117	64-72	Violent storm	Accompanied by wide-spread damage.
12	> 64	> 117,0	> 72	Hurricane	Heaviest damage and destruction.

Tab. 1: Wind force and its effects on land

7. Care and maintenance / Disposal

7.1. Transport / Storing

During transport ensure the rigging components are not stressed or damaged by mechanical forces. Use suitable transport cases.

The surface treatment temporarily protects the rigging components against moisture. However, ensure the components are in a dry state when storing and transporting them.

7.2. Visual and functional inspection

Cabinet enclosure

- Visual inspection of all fitting plates for obvious damage (e.g. cracks or corrosion).
- Inspection of all fitting plates including the front grills to ensure they are securely attached.

Locking pins

- Visual inspection for deformation of the component.
- Inspection for missing ball bearings and damage.
- Functional inspection of the release mechanism to ensure it operates properly.
- Regularly lubricate the Locking pins using WD-40® or a similar product.

Front and Splay (Rear) links

Visual inspection for deformation and damage (e.g. cracks and corrosion) including all holes of the component.

Flying frame

- Visual inspection regarding deformation and damage (e.g. cracks and corrosion) including all holes of the component.
- Regularly check the flatness of the Flying frame. For this purpose place the Flying frame on a flat surface and visually check the frame for deformation and/or torsion. In case obvious deformation and/or torsion contact d&b audioteknik for further advice.

Load adapter

- Visual inspection for deformation and damage (e.g. cracks and corrosion) including all holes of the component.

7.3. Disposal

Please dispose of this product according to the respective national regulations.

Ensure that damaged rigging components are disposed of so that they cannot be used again.

EC Declaration of Conformity

within the meaning of the EC Machine Directive 98/37/EEC

We hereby declare that the equipment designated below is designed and built in the version sold by us in such a way as to comply with the relevant fundamental safety and health criteria of the applicable EC Directive(s). This declaration shall cease to be valid if alterations are made to the equipment without our prior agreement.

This declaration covers:

d&b Z5370, T Flying frame including:

- d&b T Load adapter
- d&b T Locking pins

d&b T-Series loudspeaker cabinets (with integrated rigging components):

- d&b Z0550, T10 loudspeaker
- d&b Z0560, T-SUB loudspeaker

Relevant EC Directives:

EC Machine Directive 98/37/EC

National standards and technical specifications applied, in particular:

DIN EN ISO 12 100, BGV C1

Backnang 2009-01-19

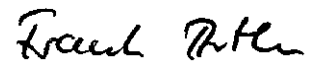

(Frank Bothe, Director)

