

Q-Series



Contents



The d&b System reality	4
The Q-Series	8
The Q1 and Qi1 loudspeakers	10
The Q7 and Qi7 loudspeakers	11
The Q10 and Qi10 loudspeakers	12
The Q and Qi subwoofers	13
The QiCSA subwoofer	14
The Qi Weather Resistant and Special Colour options	15
The Q1 rigging system	16
The Q1 rigging examples	17
The Q7/Q10 mounting accessories	18
The Q7/Q10 mounting examples	19
The Qi1 rigging system	20
The Qi1 rigging examples	21
The Qi rigging system	22
The Qi7/Qi10 rigging examples	22
The Qi7/Qi10 mounting and rigging accessories and examples	23
The d&b ArrayCalc simulation software	24
The d&b Remote network	25
The D6, D12 and D80 amplifiers	26
The operation with D6, D12 and D80 amplifiers	28
The Q-Series frequency responses	29
The d&b amplifier output modes	30
The Q-Series cables and adapters	32
The Q-Series configuration examples	34
The Q-Series product overview	38

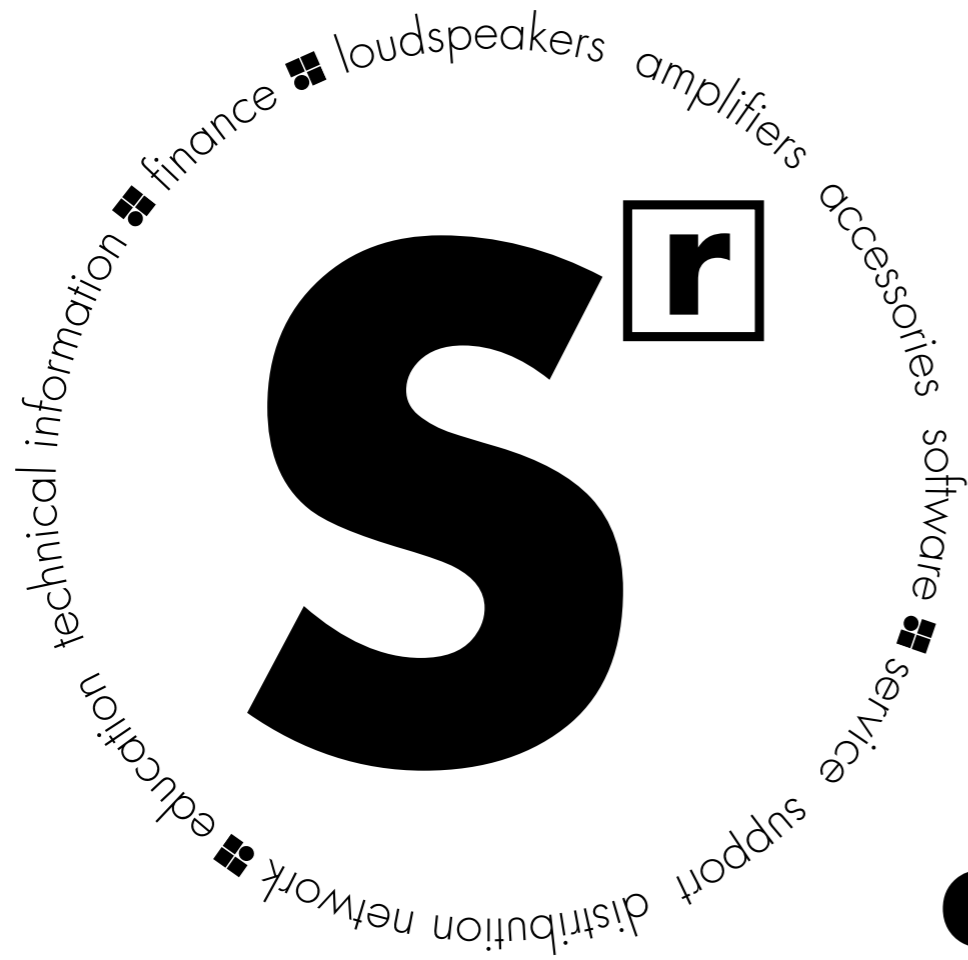

d&b System reality

As the name implies a d&b audiotechnik system is not just a loudspeaker. Nor is it merely a sum of the components: loudspeakers, amplifiers, accessories and software. Right from the outset the d&b audiotechnik approach was to build integrated sound reinforcement systems that actually are more

than the combination of parts: an entirety where each fits all. Every element is tightly specified, precisely aligned and carefully integrated to achieve maximum efficiency. For ease of use, all the user-definable parameters are integrated, allowing the possibility of adjustment, either via remote control surfaces or directly on the

amplifiers. Neutral sound characteristics leave the user all the freedom needed to realise whatever the brief. At the same time d&b offers integrated finance, service and support, a knowledgeable distribution network, education and training as well as technical information, so the same optimal acoustic result

is achieved consistently by every system anywhere, at any time. In reality: the d&b System reality.

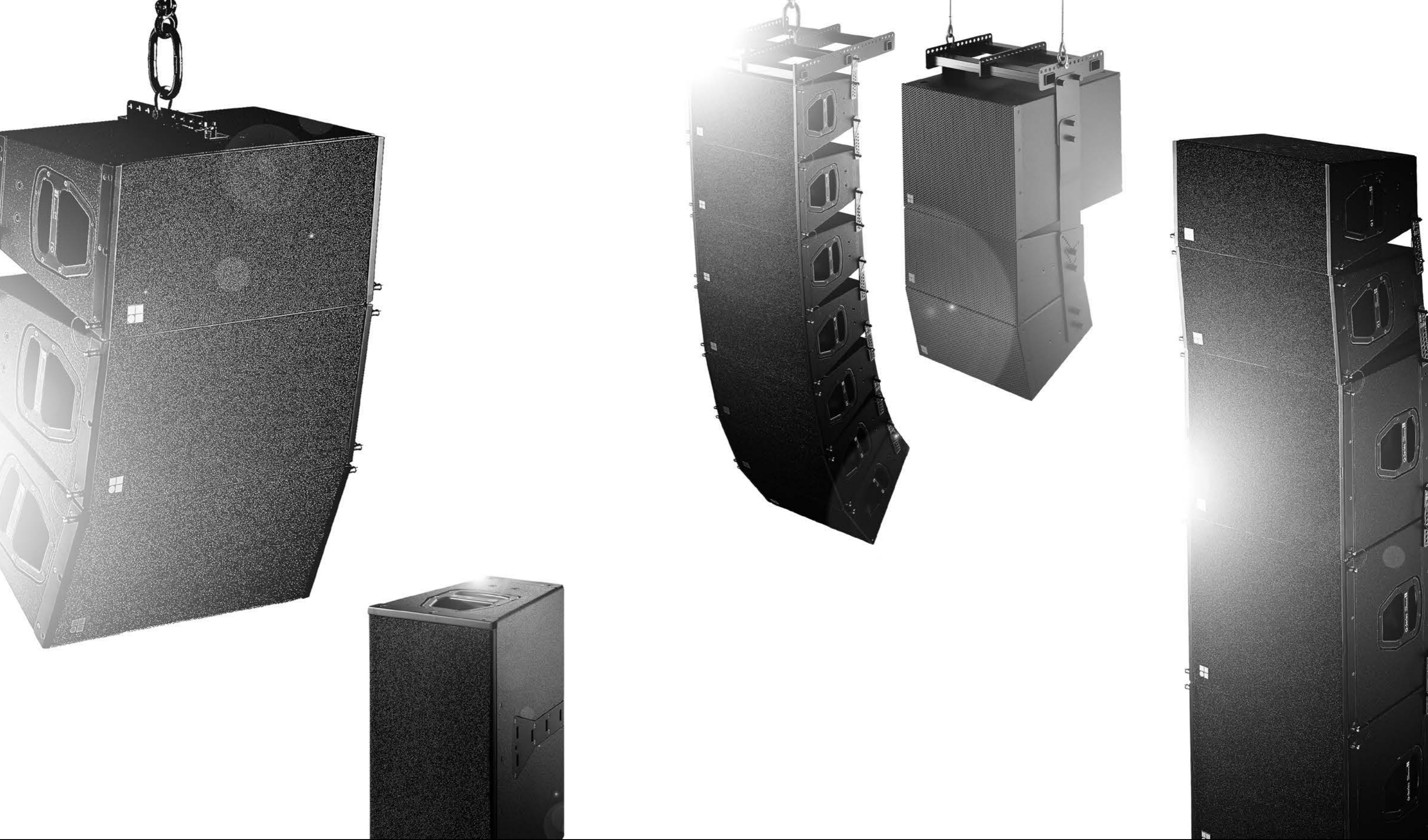

Clarity, bandwidth, high power and headroom capabilities make the **Q-Series** loudspeakers an ideal option for speech and music in many small to medium scale theatre and presentation situations, live television and orchestral shows. The scope of applications is intentionally broad, ranging from single loudspeakers right through to multiple cabinet arrays. These

flexible loudspeakers can be effortlessly and scalably combined for a multitude of small to large coherent arrays. To this end a variety of technologies are used: conventional rotatable CD horns, dipolar driver arrangements, low compression vented designs with high excursion drivers and toroidal waveshaping devices, all integrated using line array principals. The **Q loudspeakers**

are designed for a wide range of applications with a clear perspective to provide mobile, flexible, configurable array solutions to the most arduous sound reinforcement situations. The **Qi loudspeakers** differ only in cabinet construction and mounting hardware. They are intended for permanently installed performance spaces where the specification is rider driven by the

artist or mix engineer's preferences. Both the Qi loudspeakers and mounting hardware can be properly colour matched to interior designs and are weather protected for climatically hostile environments.

The Q-Series

The 2-way passively crossed over **Q1** and **Qi1**, **Q7** and **Qi7** as well as **Q10** and **Qi10** loudspeakers share the same physical size, shape and driver compliment. The highest degree of constant directivity is maintained using a large frequency overlap through the crossover range, while the recessed dipolar positioning of the two 10" low frequency drivers mechanically time aligns these with the 1.3" exit HF driver.

The Q1 and Qi1 HF drivers are fitted with a toroidal waveshaping device that has a 75° horizontal dispersion pattern.

The HF drivers of Q7 and Qi7 as well as Q10 and Qi10 are fitted to rotatable 75° x 40° and 110° x 40° (h x v) constant directivity horns respectively, allowing horns to be configured for use both vertically or horizontally. When deployed upright, the Q7 and Qi7 as well as Q10 and Qi10 are accurate stand-alone full range loudspeakers with vertical directivity control extending approximately one octave below similarly sized biaxial loudspeakers. Their horizontal coverage angles can also be used to fulfil near field or infill functions for line arrays, either flown, stacked or ground supported. When deployed horizontally with the horn rotated, the horizontal dispersion control of Q7 and Qi7 is maintained down to approximately 400 Hz. This performance can be used very effectively in critical positions close to open microphones and also allows Q7 and Qi7 loudspeakers to be combined as the near field element in Q1 and Qi1 columns.



Q1 loudspeaker



Qi1 loudspeaker



Q7, Q10 loudspeaker



Qi7, Qi10 loudspeaker

The **Q**, **Qi** and **QiCSA** subwoofers complete the Series, sharing the same width as the other loudspeakers and having compatible flying fittings that enable their use in columns with Q and Qi loudspeakers respectively. The Q, Qi and QiCSA-SUB cabinets are bass-reflex designs with an 18" high excursion driver. Multiples of three Q-SUBs or two Qi-SUBs and one QiCSA-SUB can be combined to produce Cardioid Subwoofer Arrays (CSA).

The d&b software offering aides the entire system setup process, from the simulation and planning of the loudspeaker systems, to the remote control and monitoring of the system functions during the event, followed by service functionality to verify system performance prior to de-rigging. The **ArrayCalc** simulation software allows the virtual optimization of loudspeaker line arrays, point source and column loudspeakers as well as subwoofers and their adjustment to venue conditions. Using the R1 export function, a project file containing the simulation data, including the respective amplifier settings is generated for deployment in the **R1** Remote control software. R1 then feeds the settings to the amplifiers from a central location to allow rapid verification and fine adjustment on site. Service functions enable firmware updates of the amplifiers as and when these are available.

The d&b **D6** and **D12** dual channel as well as the **D80** four channel amplifiers realize the complete system and incorporate d&b loudspeaker specific configuration information. They provide three different power ranges and have analog and digital signal inputs and links. These devices are specially designed and manufactured by d&b utilizing Digital Signal Processing and include switchable functions for precisely tailoring system response for a wide variety of applications. Delay capabilities and equalization on each channel of every amplifier reduce the need for external processing devices, with user definable 4-band parametric EQ for the D6 and D12 compared to the two 16-band equalizers incorporated into the D80.



Q subwoofer



Qi, QiCSA subwoofer



D6 amplifier



D12 amplifier



D80 amplifier

The Q1 and Qi1 loudspeakers

Q1 and Qi1 loudspeakers

The Q1 and Qi1 are line array loudspeakers for use in vertical columns. The Qi1 is the installation version of the Q1 loudspeaker, it differs only in cabinet construction and mounting hardware. The Q1 and Qi1 cabinets are passive 2-way designs housing two 10" LF drivers and a 1.3" HF compression driver with a toroidal waveshaping device to achieve a 75° horizontal dispersion characteristic. The two 10" neodymium LF drivers are positioned in a dipolar arrangement providing an exceptional dispersion control even at lower frequencies, with the 75° nominal dispersion angle being maintained down to 400 Hz.

Q1 and Qi1 cabinets can be combined with the respective Q and Qi subwoofer systems: in mixed line array setups, as a separate subwoofer column or in ground stacked applications. For further extension of bandwidth and headroom ground stacked J-INFRA subwoofers can be used.

The Q1 and Qi1 cabinets are constructed from marine plywood and have an impact resistant paint finish. The front of the loudspeaker cabinets are covered with a replaceable acoustically transparent foam and protected by a rigid metal grill. Four M10 threaded inserts on each side panel of the Qi1 cabinet enclosure are provided for attaching installation hardware whilst the Q1 cabinet incorporates a pair of handles and has integrated line array rigging hardware.

System data

Frequency response (-5 dB standard).....	60 Hz - 17 kHz
Frequency response (-5 dB CUT mode).....	100 Hz - 17 kHz
Max. sound pressure (1 m, free field) ¹	
with D6.....	135 dB
with D12	139 dB
with D80	139 dB
Input level (100 dB SPL/1 m).....	-18 dBu

Loudspeaker data

Nominal impedance.....	8 ohms
Power handling capacity (RMS/peak 10 msec)	400/1600 W
Nominal dispersion angle (h)	75°
Components.....	2 x 10" driver/1.3" compression driver
.....	passive crossover network
Connections Q1	2 x NLT4 F/M
.....	optional 2 x EP5 or 2 x NL4
Connections Qi1.....	2 x NL4
Weight Q1/Qi1	22/21 kg (49/46 lb)

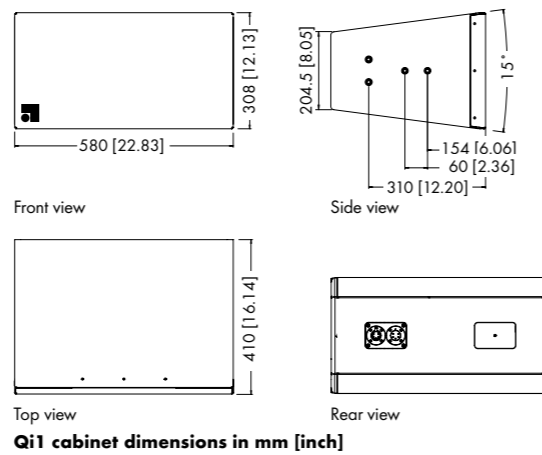
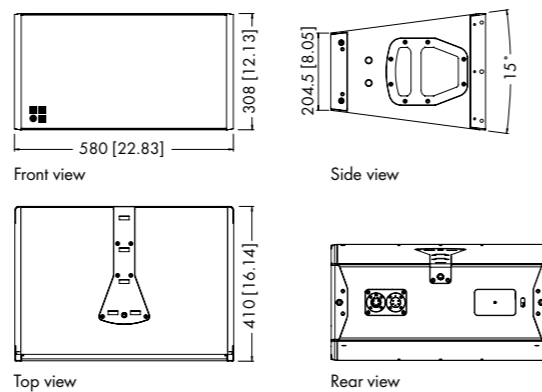
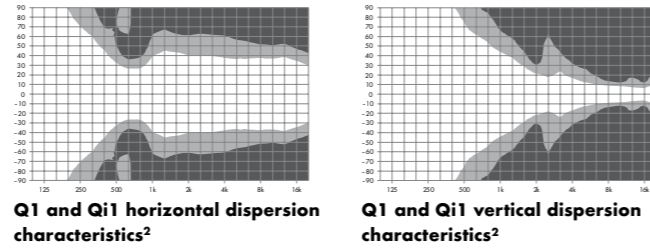

The Q7 and Qi7 loudspeakers

Q7 and Qi7 loudspeakers

The Q7 and Qi7 are full range loudspeakers. The Qi7 is the installation version of the Q7 loudspeaker, it differs only in cabinet construction and mounting hardware.

The Q7 and Qi7 are 75° x 40° passive 2-way cabinets housing two 10" LF drivers and a 1.3" HF compression driver with a rotatable constant directivity horn and a passive crossover network. The two 10" neodymium LF drivers are positioned in a dipolar arrangement providing exceptional vertical dispersion control with the 40° nominal angle being maintained down to 400 Hz. The precisely controlled 75° horizontal dispersion performance provides the ideal pattern for many medium throw requirements. The horn can be rotated by 90°.

The Q7 and Qi7 can be used as stand-alone full range systems in combinations with other Q and Qi loudspeakers, ground stacked or mounted on a high stand. Q7 and Qi7 cabinets can also be combined in flown array systems.

The Q7 and Qi7 cabinets are constructed from marine plywood and have an impact resistant paint finish. The front of the loudspeaker cabinets are covered with a replaceable acoustically transparent foam and protected by a rigid metal grill. Four M10 threaded inserts on each side panel of the Qi7 cabinet enclosure are provided for attaching installation hardware whilst the Q7 cabinet incorporates a pair of handles and has integrated line array rigging hardware.

System data

Frequency response (-5 dB standard).....	60 Hz - 17 kHz
Frequency response (-5 dB CUT mode).....	100 Hz - 17 kHz
Max. sound pressure (1 m, free field) ¹	
with D6.....	134 dB
with D12	138 dB
with D80	138 dB
Input level (100 dB SPL/1 m)	-17 dBu

Loudspeaker data

Nominal impedance.....	8 ohms
Power handling capacity (RMS/peak 10 msec)	400/1600 W
Nominal dispersion angle (h x v).....	75° x 40°
Components.....	2 x 10" driver/1.3" compression driver
.....	passive crossover network
Connections Q7	2 x NLT4 F/M
.....	optional 2 x EP5 or 2 x NL4
Connections Qi7.....	2 x NL4
Weight Q7/Qi7	22/21 kg (49/46 lb)

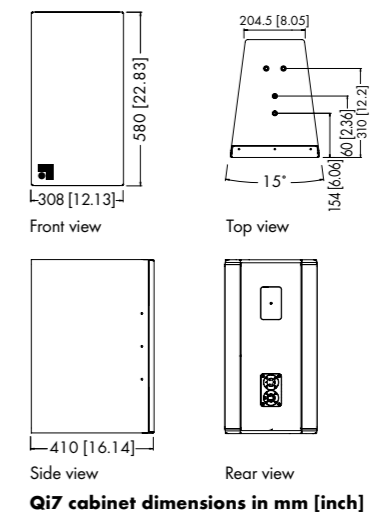
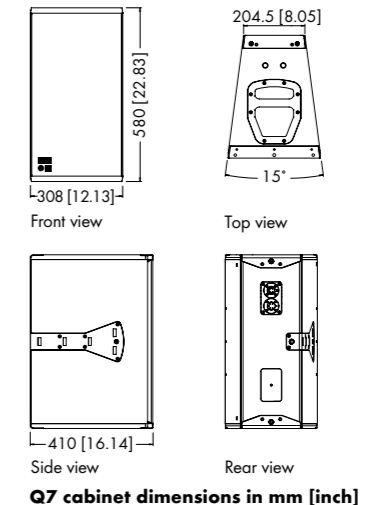
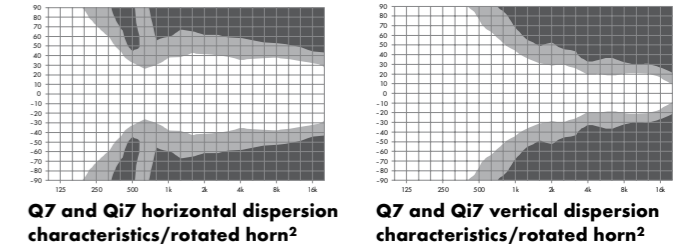
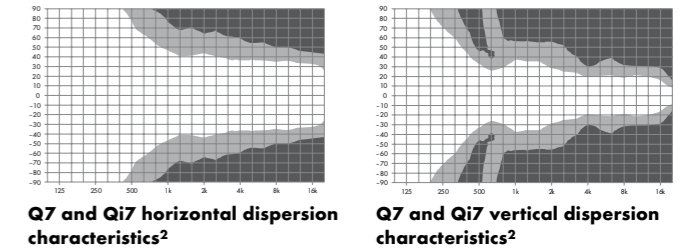

¹ Broadband measurement, pink noise, crest factor 4, peak measurement, linear weighting
² Dispersion angle vs frequency plotted using lines of equal sound pressure (isobars) at -6 dB and -12 dB

¹ Broadband measurement, pink noise, crest factor 4, peak measurement, linear weighting
² Dispersion angle vs frequency plotted using lines of equal sound pressure (isobars) at -6 dB and -12 dB

The Q10 and Qi10 loudspeakers

Q10 and Qi10 loudspeakers

The Q10 and Qi10 are full range loudspeakers. The Qi10 is the installation version of the Q10 loudspeaker, it differs only in cabinet construction and mounting hardware.

The Q10 and Qi10 are 110° x 40° passive 2-way cabinets housing two 10" LF drivers and a 1.3" HF compression driver with a rotatable constant directivity horn and a passive crossover network. The two 10" neodymium LF drivers are positioned in a dipolar arrangement providing exceptional vertical dispersion control with the 40° nominal angle being maintained down to 400 Hz.

Q10 and Qi10 can be used as stand-alone full range systems, in combinations with other Q and Qi cabinets ground stacked or mounted on a high stand. The wide constant directivity performance provides remarkable transparency when used in close proximity to listeners. It is also ideally suited to ambient and distributed sound reinforcement tasks. When used in the upright configuration the Q10 and Qi10 have a very accurate 110° horizontal constant directivity behaviour that is maintained down to approximately 800 Hz.

The Q10 and Qi10 cabinets are constructed from marine plywood and have an impact resistant paint finish. The front of the loudspeaker cabinets are covered with a replaceable acoustically transparent foam and protected by a rigid metal grill. Four M10 threaded inserts on each side panel of the Qi10 cabinet enclosure are provided for attaching installation hardware whilst the Q10 cabinet incorporates a pair of handles and has integrated rigging hardware.

System data

Frequency response (-5 dB standard) 60 Hz - 17 kHz
 Frequency response (-5 dB CUT mode)..... 100 Hz - 17 kHz
 Max. sound pressure (1 m, free field)¹
 with D6 133 dB
 with D12 137 dB
 with D80 137 dB
 Input level (100 dB SPL/1 m) -17 dBu

Loudspeaker data

Nominal impedance 8 ohms
 Power handling capacity (RMS/peak 10 msec) 400/1600 W
 Nominal dispersion angle (h x v) 110° x 40°
 Components 2 x 10" driver/1.3" compression driver
 passive crossover network
 Connections Q10 2 x NLT4 F/M
 optional 2 x EP5 or 2 x NL4
 Connections Qi10 2 x NL4
 Weight Q10/Qi10 22/21 kg (49/46 lb)

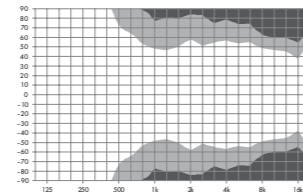

Q10 and Qi10 horizontal dispersion characteristics²

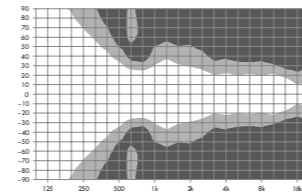

Q10 and Qi10 vertical dispersion characteristics²

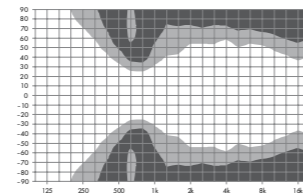

Q10 and Qi10 horizontal dispersion characteristics/rotated horn²

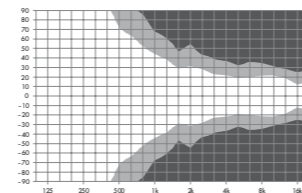

Q10 and Qi10 vertical dispersion characteristics/rotated horn²

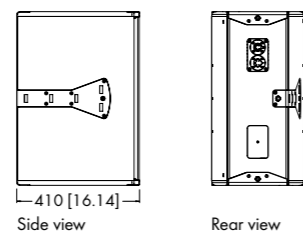
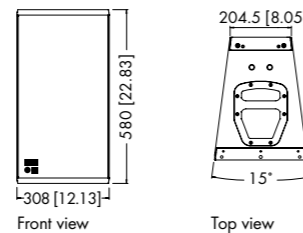

Q10 cabinet dimensions in mm [inch]

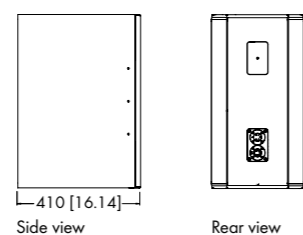
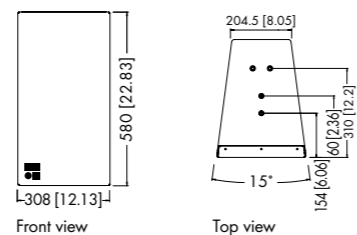

Qi10 cabinet dimensions in mm [inch]

The Q and Qi subwoofers

Q and Qi subwoofers

The Q-SUB and Qi-SUB are the dedicated subwoofers for the Q and Qi loudspeakers respectively and can be used to supplement the top cabinets in various combinations, either flown or ground stacked. The Qi-SUB is the installation version of the Q-SUB, differing only in cabinet construction and mounting hardware. The Q and Qi subwoofers are actively driven bass reflex designs, housing a long excursion 18" driver.

The subwoofers can be combined with the respective Q and Qi loudspeakers in line arrays, as a separate column or in ground stacked applications where the subwoofers also mechanically support the top loudspeakers.

The Q and Qi subwoofer cabinets are constructed from marine plywood and have an impact resistant paint finish. The Qi-SUB is also available in Special Colour (SC) and Weather Resistant (WR) options. The front of the subwoofer cabinets are covered with a replaceable acoustically transparent foam and protected by a rigid metal grill.

Installation hardware is attached to the Qi-SUB enclosure through four M10 threaded inserts on each side panel. The Q-SUB incorporates a pair of handles, a M20 threaded flange in the top panel and integrated line array rigging hardware.

System data

Frequency response (-5 dB standard) 40 Hz - 130 Hz
 Frequency response (-5 dB 100 Hz mode) 40 Hz - 100 Hz
 Max. sound pressure (1 m, free field)¹
 with D6 129 dB
 with D12 133 dB
 with D80 133 dB

Loudspeaker data

Nominal impedance 8 ohms
 Power handling capacity (RMS/peak 10 msec) 400/1600 W
 Components 18" driver
 Connections 2 x NLT4 F/M
 optional 2 x EP5 or 2 x NL4
 Weight 42 kg (92.6 lb)

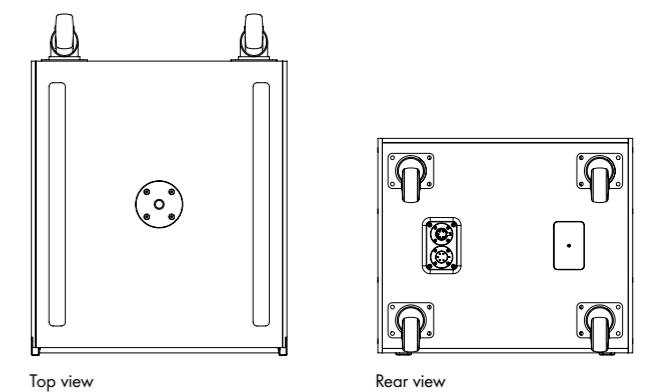
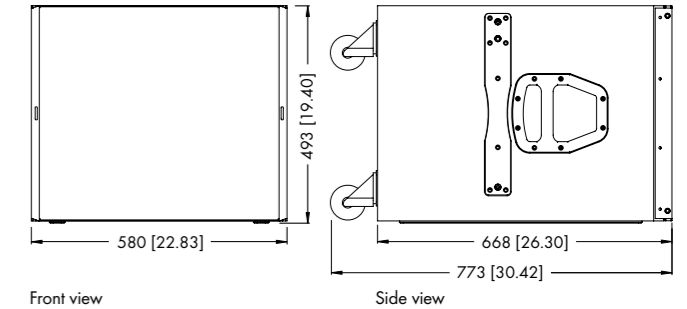

Q-SUB cabinet dimensions in mm [inch]

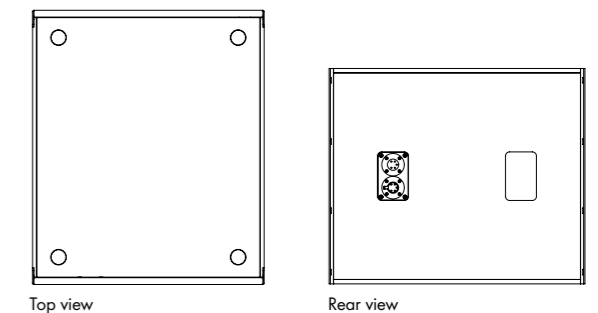
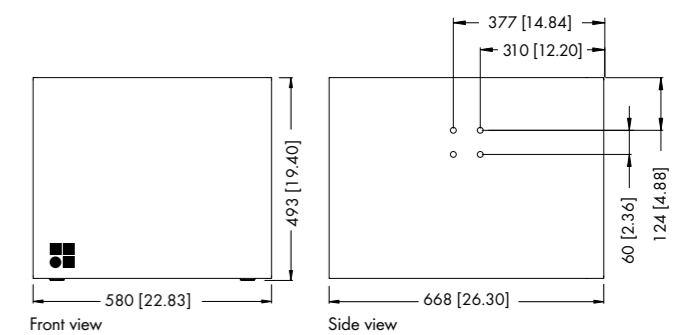

Qi-SUB cabinet dimensions in mm [inch]

¹ Broadband measurement, pink noise, crest factor 4, peak measurement, linear weighting
² Dispersion angle vs frequency plotted using lines of equal sound pressure (isobars) at -6 dB and -12 dB

¹ Broadband measurement, pink noise, crest factor 4, peak measurement, linear weighting

The QiCSA subwoofer

QiCSA subwoofer

The QiCSA subwoofer is a specifically designed version of the Qi-SUB for use as the rear facing element in Cardioid Sub Arrays (CSA) only. The QiCSA-SUB only differs from the Qi-SUB visually, as the CSA version features a grill and foam on both the front and the back of the loudspeaker to visually integrate with Qi-SUB's in an array. The QiCSA subwoofer is an actively driven bass reflex design, housing a long excursion 18" driver.

The QiCSA subwoofer cabinet is constructed from marine plywood and has an impact resistant paint finish. The QiCSA is also available in Special Colour (SC) and Weather Resistant (WR) options. The front and rear of the subwoofer cabinets are covered with a replaceable acoustically transparent foam and protected by a rigid metal grill. The grill facing backwards is fitted with a single NL4 connector at the bottom left hand side.

Installation hardware is attached to the QiCSA-SUB enclosure through four M10 threaded inserts on each side panel.

System data

Frequency response (-5 dB standard)	40 Hz - 130 Hz
Frequency response (-5 dB 100 Hz mode)	40 Hz - 100 Hz
Max. sound pressure (1 m, free field) ¹	
with D6	129 dB
with D12	133 dB
with D80	133 dB

Loudspeaker data

Nominal impedance	8 ohms
Power handling capacity (RMS/peak 10 msec)	400/1600 W
Components	18" driver
Connections	2 x NL4/1 x NL4
Weight	40 kg (88 lb)

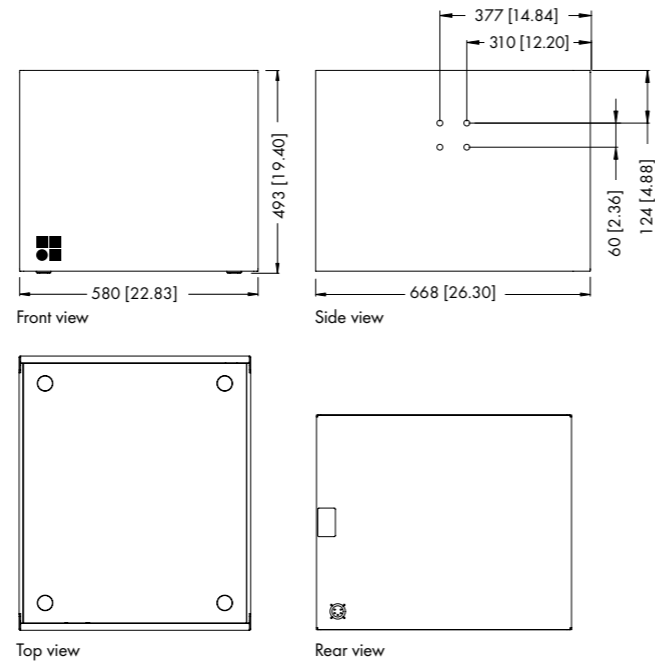

QiCSA-SUB cabinet dimensions in mm (inch)

The Qi Weather Resistant and Special Colour options

The Weather Resistant and Special Colour options are only available to order with the Qi version cabinets and appropriate accessories.

Weather Resistant (WR) option

The WR option enables operation of loudspeakers in changing ambient conditions, however it is not intended to enable permanent, unprotected operation of loudspeakers outdoors. Cabinets being used outdoors even with the WR option should always be aimed either horizontally or with a downward tilt. The QiCSA-SUB should only be aimed horizontally. An additional cover should be positioned over the loudspeakers.

Qi loudspeakers with the Weather Resistant option are supplied with a fixed cable. Cable type H-07-RN-F 2 x 2.5 mm²/AWG 13 with a length of 5.5 m (18 ft) as standard or length as required.

Special Colour (SC) option

The paint finish of all loudspeaker cabinets and most accessories can be executed in almost all RAL colours in accordance with the RAL colour table. Items such as chains, fixing screws, shackles, eyebolts and screws are not painted. Other paint finishes such as metallic are available on request. The acoustically transparent foam fitted behind the rigid metal grill is also painted with the requested RAL colour.

The Q1 rigging system

The Q1 rigging examples

Safety approval

d&b loudspeakers and accessories are designed for setup and use within situations requiring compliance with the provisions and directives of BGV C1 Rule for the Prevention of Accidents.

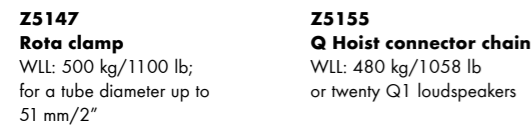
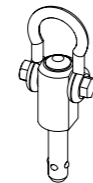
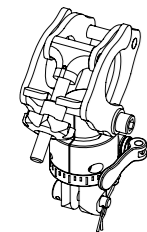
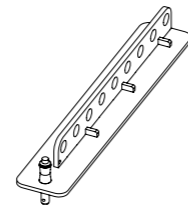
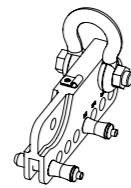
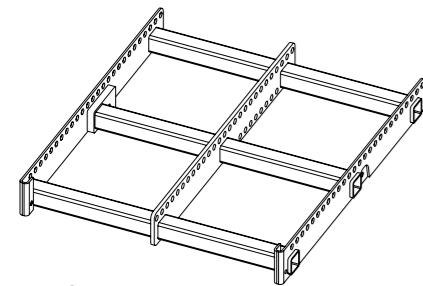
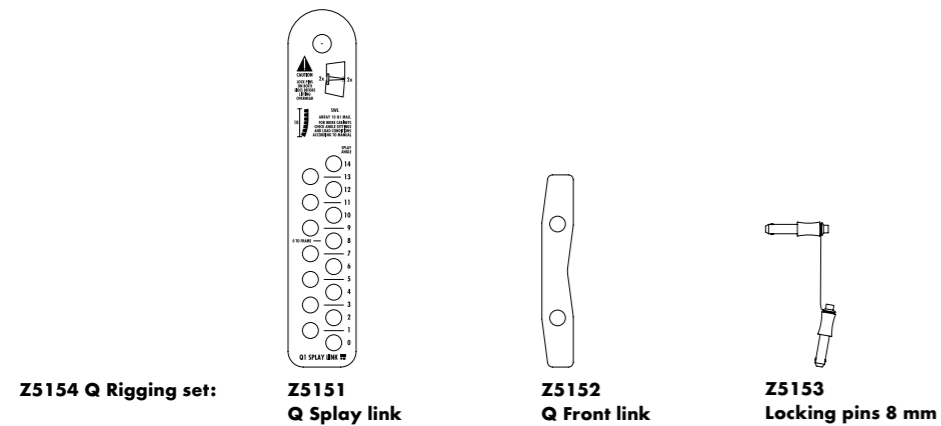

With a 15° vertical HF dispersion per cabinet, the Q1 can be used to construct vertical columns that produce a curved coherent wave front. The mechanical and acoustical design of the cabinet enables vertical splay angles to be set between 0° and 14°. Q1 cabinets can therefore be used in vertical configurations starting from two cabinets with a 15° to 30° dispersion, up to twenty cabinets with a fully user and venue defined vertical profile. For further information please refer to the TI 385 d&b Line array design and Q-Series Rigging manual, which are available for download at www.dbaudio.com.

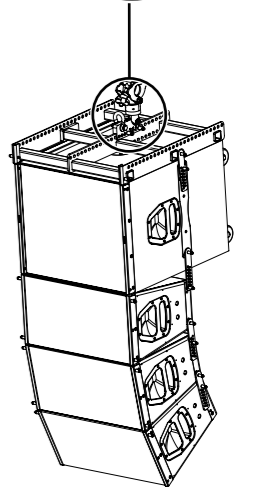
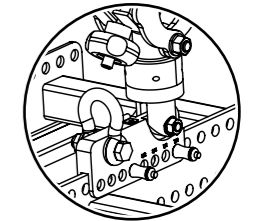
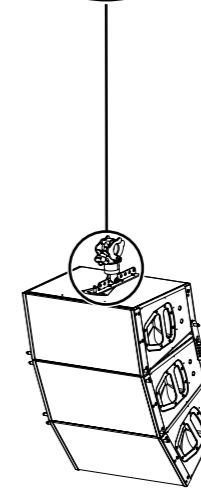
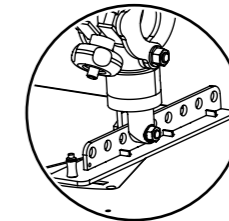
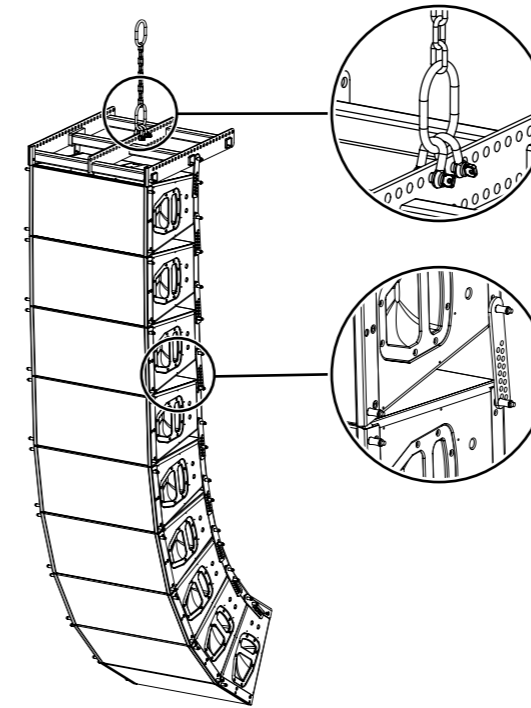
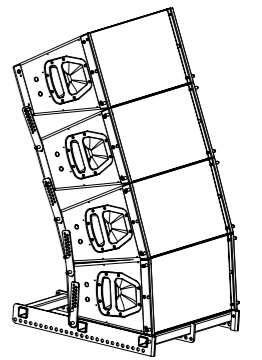
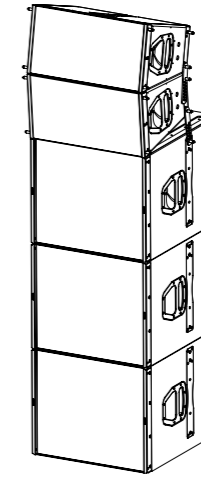

The Q7/Q10 mounting accessories

The Q7/Q10 mounting examples

Safety approval

d&b loudspeakers and accessories are designed for setup and use within situations requiring compliance with the provisions and directives of BGV C1 Rule for the Prevention of Accidents.

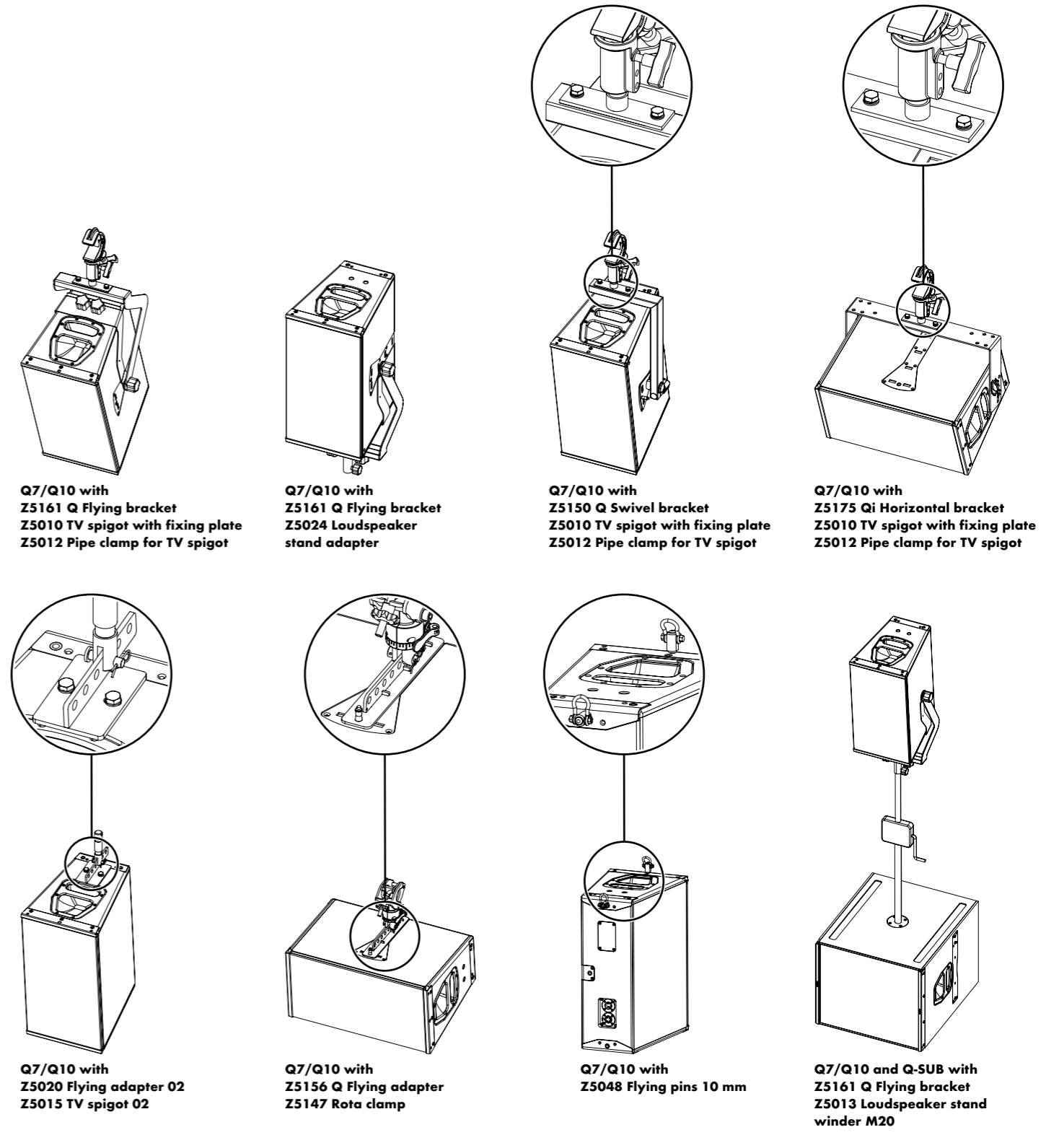
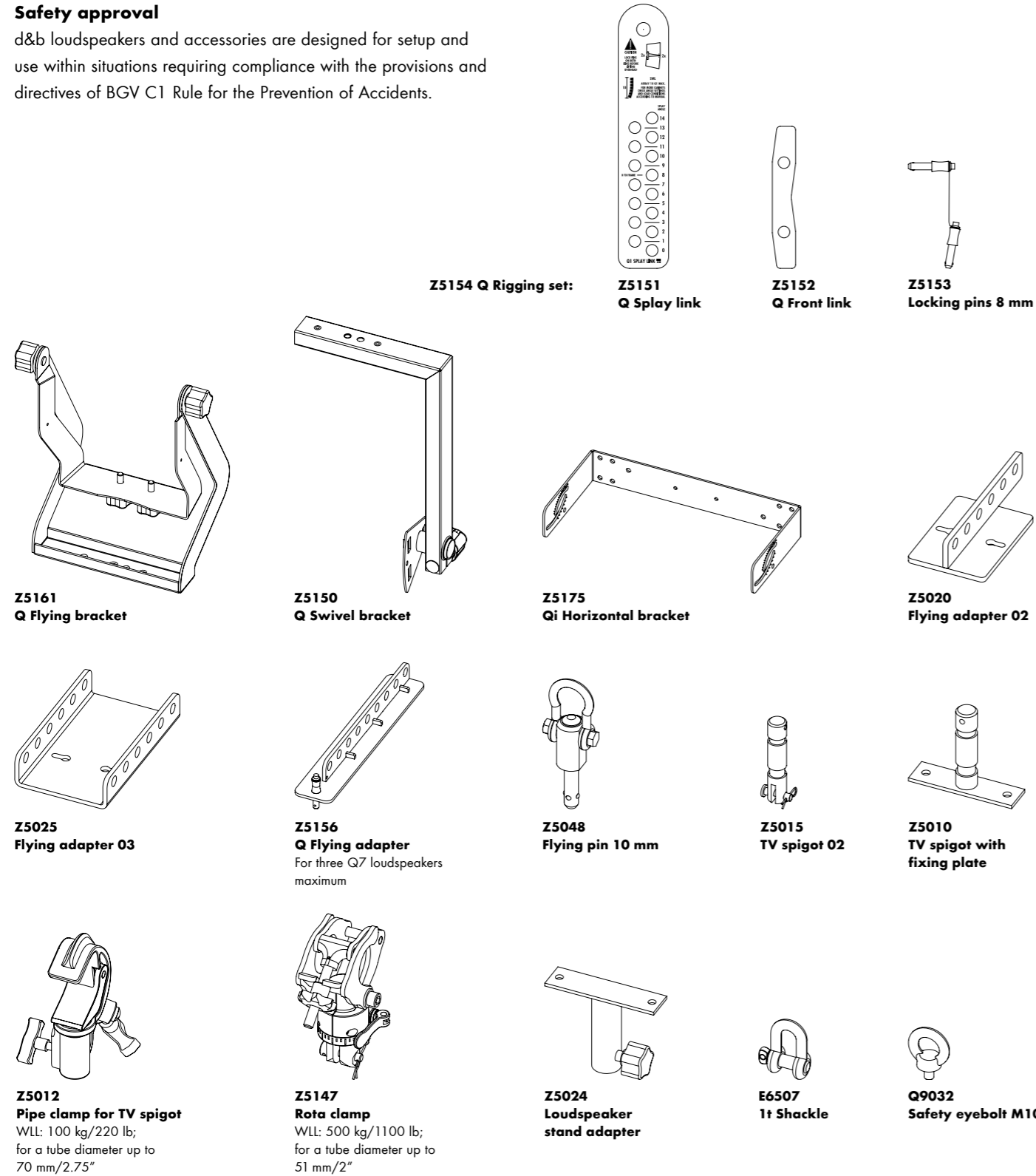

The Qi1 rigging system

Safety approval

d&b loudspeakers and accessories are designed for setup and use within situations requiring compliance with the provisions and directives of BGV C1 Rule for the Prevention of Accidents.

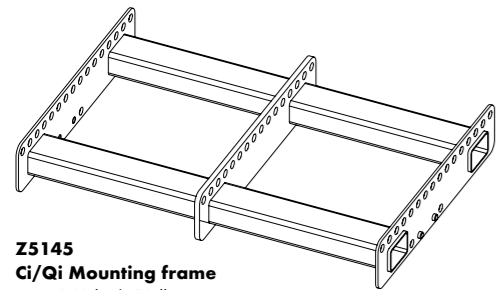

Z5145
Ci/Qi Mounting frame
WLL: 240 kg/530 lb
e.g. nine Q loudspeakers

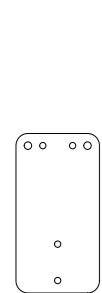

Z5170
Qi Mounting adapter

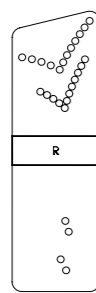

Z5171
Qi Mounting plate

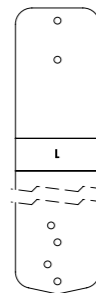

Z5172
Qi-SUB
Mounting plate

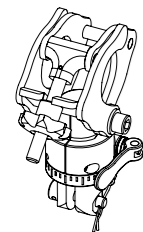

Z5147
Rota clamp
WLL: 500 kg/1100 lb;
for a tube diameter up to
51 mm/2"

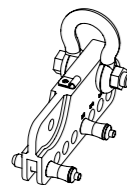

Z5160
Q Load adapter
WLL: 480 kg/1058 lb
or 20 Qi1 loudspeakers;
aiming of a column by 1/1,
1/2 or 1/4 detents

The Qi1 rigging examples

With a 15° vertical HF dispersion per cabinet, the Qi1 can be used to construct vertical columns that produce a curved coherent wave front. The mechanical and acoustical design of the cabinet enables vertical splay angles to be set between 0° and 14°. Qi1 cabinets can therefore be used in vertical configurations starting from two cabinets with a 15° to 30° dispersion, up to nine cabinets with a fully user and venue defined vertical profile. Qi subwoofers can be integrated at any position within the array. Three subwoofers can be mounted together in CSA mode, where the centre QiCSA-SUB radiates to the back. For further information please refer to the TI 385 d&b Line array design, which is available for download at www.dbaudio.com.

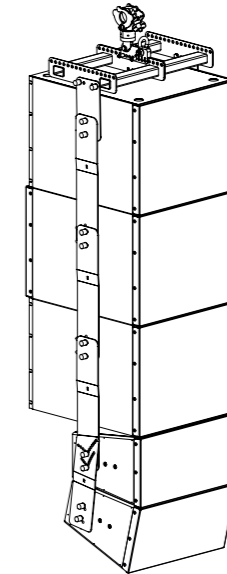

Qi-SUB/QiCSA-SUB
Cardioid Subwoofer Array
front view

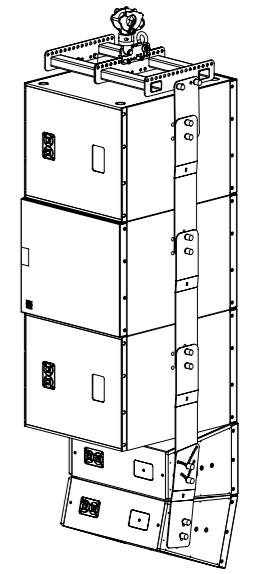

Qi-SUB/QiCSA-SUB
Cardioid Subwoofer Array
back view

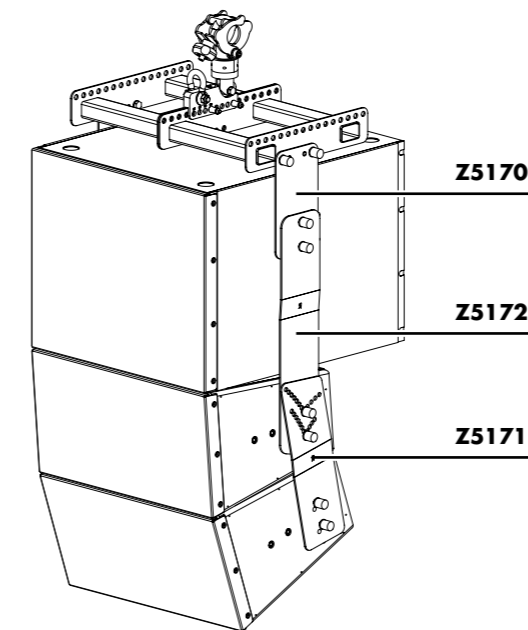

Flown Qi1/Qi-SUB array with
Z5145 Ci/Qi Mounting frame
Z5160 Q Load adapter
Z5147 Rota clamp
Z5170 Qi Mounting adapter
Z5171 Qi Mounting plate
Z5172 Qi-SUB Mounting plate

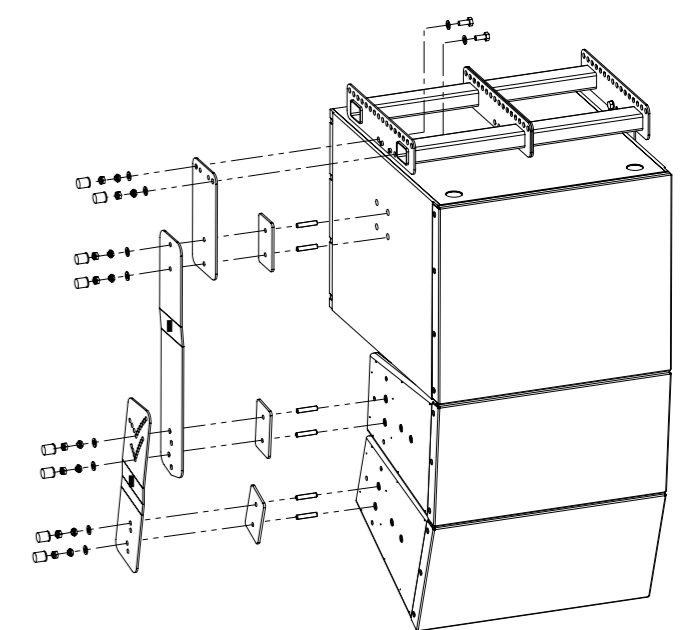

Qi rigging system

The Qi rigging system

The Qi7/Qi10 rigging examples

Safety approval

d&b loudspeakers and accessories are designed for setup and use within situations requiring compliance with the provisions and directives of BGV C1 Rule for the Prevention of Accidents.

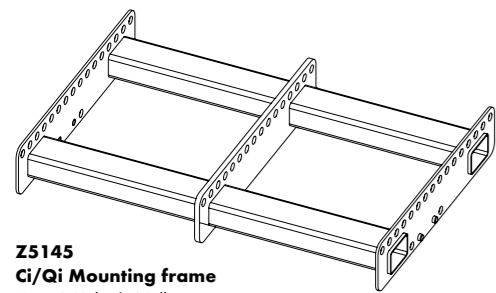

Z5145
Ci/Qi Mounting frame
WLL: 240 kg/530 lb

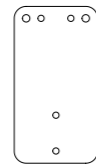

Z5170
Qi Mounting adapter

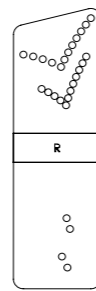

Z5171
Qi Mounting plate

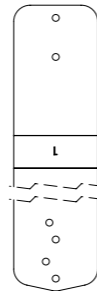

Z5172
Qi-SUB
Mounting plate

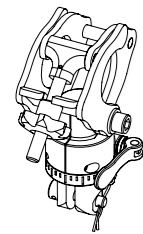

Z5147
Rota clamp
WLL: 500 kg/1100 lb;
for a tube diameter up to
51 mm/2"

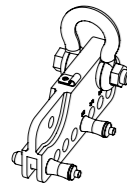

Z5160
Q Load adapter
WLL: 480 kg/1058 lb;
aiming of a column by 1/1,
1/2 or 1/4 detents

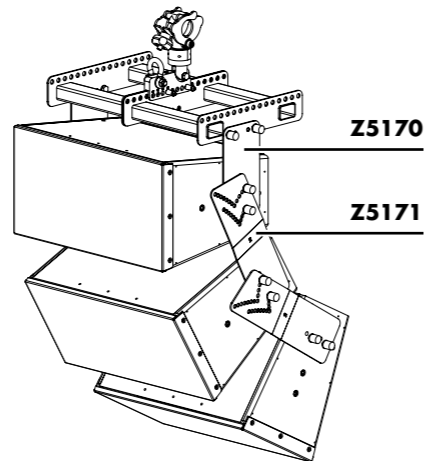

Flown Qi7/Qi10 array with
Z5145 Ci/Qi Mounting frame
Z5160 Q Load adapter
Z5147 Rota clamp
Z5170 Qi Mounting adapter
Z5171 Qi Mounting plate

The Qi7/Qi10 mounting and rigging accessories and examples

Safety approval

d&b loudspeakers and accessories are designed for setup and use within situations requiring compliance with the provisions and directives of BGV C1 Rule for the Prevention of Accidents.

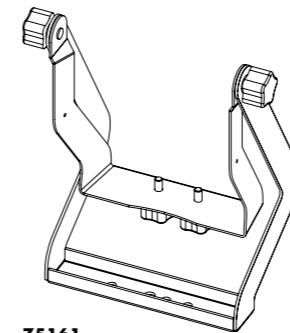

Z5161
Q Flying bracket

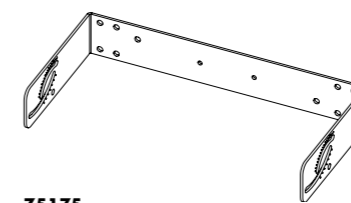

Z5175
Qi Horizontal bracket

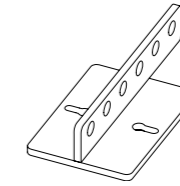

Z5020
Flying adapter 02

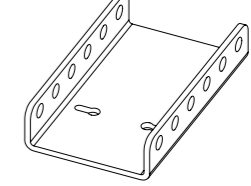

Z5025
Flying adapter 03

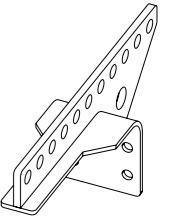

Z5054
Ci60/Ci90
Flying adapter



Z5044
MAX Bracket
connector

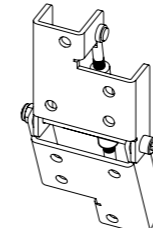

Z5053
Ci60/Ci90 Bracket
connector

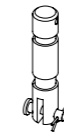

Z5015
TV spigot 02

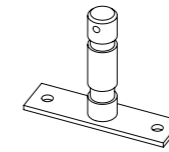

Z5010
TV spigot with
fixing plate

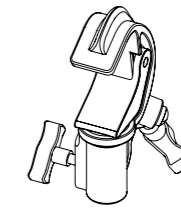

Z5012
Pipe clamp for TV spigot
WLL: 100 kg/220 lb;
for a tube diameter up to
70 mm/2.75"

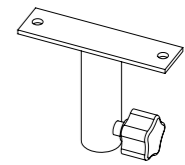

Z5024
Loudspeaker
stand adapter



E6507
1t Shackle

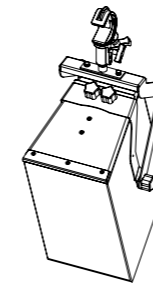

Qi7/Qi10 with
Z5161 Q Flying bracket
Z5010 TV spigot with fixing plate
Z5012 Pipe clamp for TV spigot

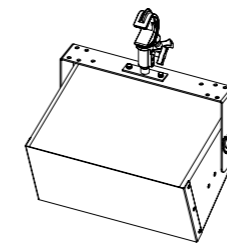

Qi7/Qi10 with
Z5175 Qi Horizontal bracket
Z5010 TV spigot with fixing plate
Z5012 Pipe clamp for TV spigot

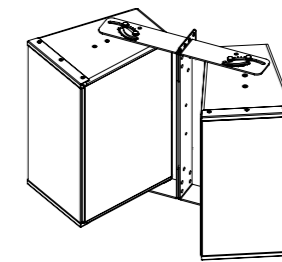

Qi7/Qi10 horizontal array with
Z5175 Qi Horizontal bracket
Z5044 MAX Bracket connector

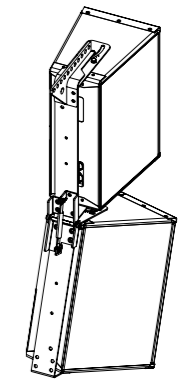

Qi7/Qi10 vertical array with
Z5054 Ci60/Ci90 Flying adapter
Z5175 Qi Horizontal bracket
Z5053 Ci60/Ci90 Bracket connector

The d&b ArrayCalc simulation software

The d&b ArrayCalc simulation software is the simulation tool for d&b line arrays, column and point source loudspeakers as well as subwoofers. This is a comprehensive toolbox for all tasks associated with acoustic design, performance prediction, alignment, rigging and safety parameters. For safety reasons d&b line arrays must be designed using the d&b ArrayCalc simulation software.

d&b ArrayCalc is available as a native stand-alone application for both Microsoft Windows¹ (Win7 or higher) and Mac OS X² (10.6 or higher) operating systems. In combination with the d&b Remote network, this can significantly reduce setup and tuning time in mobile applications, and allows for precise initial simulations when planning installations.

Listening planes in three dimensions can be defined, creating a representation of the audience areas in a given venue. This includes areas such as typical listening planes, arenas, balconies, side stalls, and in the round. Special functions assist in obtaining accurate dimensions with laser distance finders and inclinometers.

Acoustic obstacles, such as arena video score boards can be added to a model.

The ArrayCalc R1 export function produces a project file for the R1 Remote control software. Complete details of the system simulated in ArrayCalc are generated, including loudspeakers, amplifiers, remote IDs, groups and all configuration information. This workflow sequence removes the need to manually transfer data from one software program to the other. EASE and DXF data export capabilities are also available.

Further information is provided in the d&b Amplifier and Software brochure which is available for download at www.dbaudio.com.

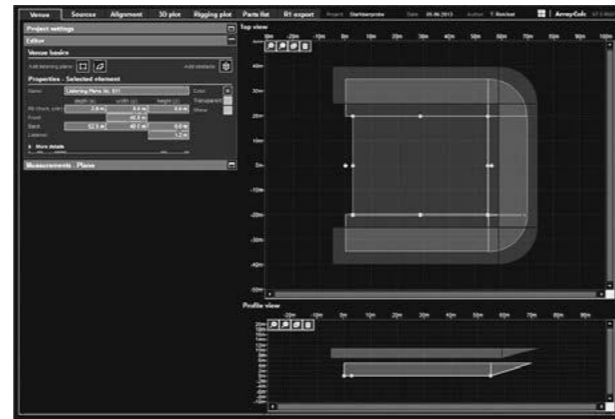

Venue editor

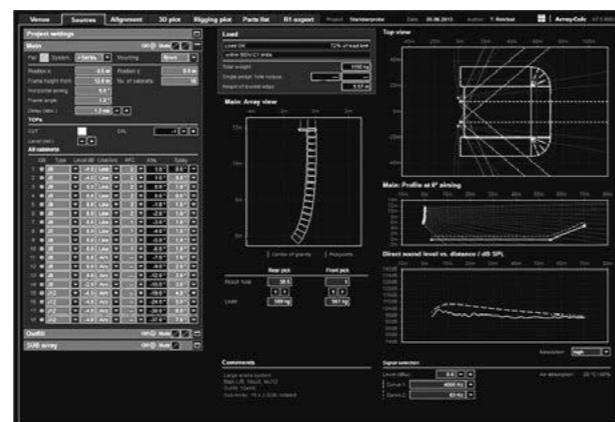

Sources, array

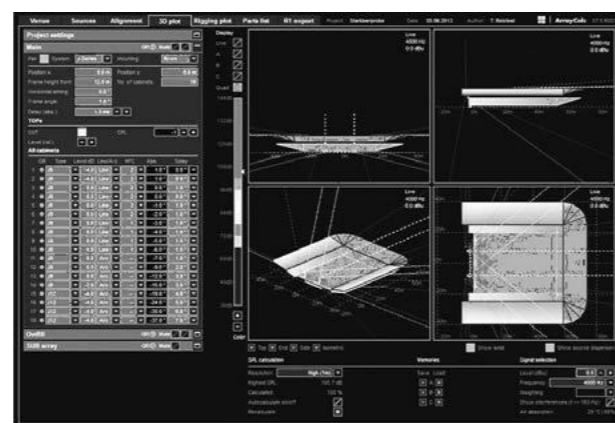

3D Plot quad

The d&b Remote network

The remote control capability of the d&b Remote network enables central control and monitoring of a complete d&b loudspeaker system from anywhere in the network, be it from a computer in the control room, at the mix position, or on a wireless tablet in the auditorium. This central access to all functions through the d&b Remote network, to controls as well as detailed system and device diagnostics information, unlocks the full potential of the d&b system approach. In a typical user workflow, the d&b Remote network takes settings optimized in the ArrayCalc simulation software and applies these to all the amplifiers within the network. The importation of settings from ArrayCalc allows the system configuration to be quickly accomplished, providing more time for verification and fine tuning.

All features, functions and controls available on the front panel of d&b amplifiers may be remotely controlled and/or monitored using R1 Remote control software. This allows each channel of the amplifier to be controlled and enables the creation of groups of loudspeakers. When grouped together, a button or fader can control the overall system level, zone level, equalization and delay, power ON/OFF, MUTE, as well as loudspeaker specific function switches such as CUT/HFA/HFC and CPL. An offline mode is provided for preparation in advance of an event, without the amplifiers being present or connected.

For mobile applications, d&b System check verifies that the system performs within a predefined condition. Extensive facilities for storing and recalling system settings are provided allowing these to be repeated, as and when required. Project files can be easily adjusted for use with a different set of equipment at another location.

In installation projects system integrators can configure the d&b Remote network to offer access to different levels of control, tailored to the operational demands. For example, power ON/OFF for daily use, or more complex functionality for detailed control. Password protection is available to restrict access. Input and Load monitoring allow installation operators to ensure optimum performance at all times.

R1 Remote control software enables d&b amplifiers to be remotely controlled using both Ethernet and CAN-Bus in parallel. The software is optimized for use with touch screen, mouse and keyboard and runs on both Microsoft Windows¹ (Win7 or higher) and Mac OS X² (10.6 or higher) operating systems.

Further information is provided in the d&b Amplifier and Software brochure which is available for download at www.dbaudio.com.

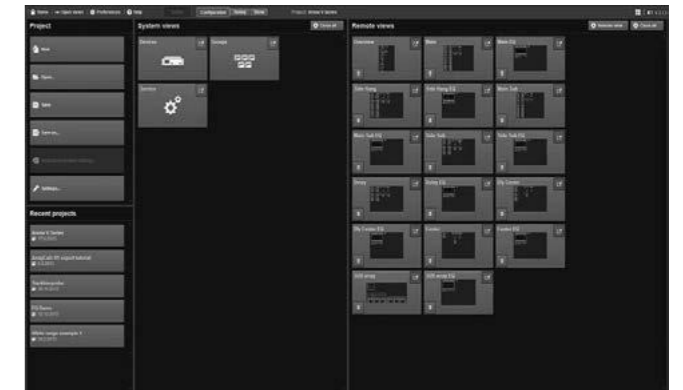

Home



Remote in Configuration mode



Open views

¹ Microsoft Windows is a registered trademark or trademark of Microsoft Corporation in the United States and/or other countries
² Mac OS is a trademark of Apple Inc., registered in the U.S. and other countries

The D6, D12 and D80 amplifiers

Two decades have passed since d&b embarked on integrating Digital Signal Processing (DSP) into power amplifiers. It is over ten years since all d&b amplifiers used this technology and included analog and digital signal inputs, extensive loudspeaker control, configuration and protection functions, user definable equalization, delay and the all embracing remote control functionality as standard.

The d&b amplifiers sit right at the very heart of the d&b systems, providing sophisticated control capabilities as well as the power to efficiently drive d&b loudspeakers in whatever the particular application. The amplifiers are developed and manufactured by d&b and incorporate loudspeaker specific setups. Sophisticated protection circuits modelling thermal and mechanical driver behaviour are provided, resulting in the sustained reliability of d&b systems. Switchable functions for precisely tailoring system response in a wide variety of applications are also included, integrating complete loudspeaker system management into the amplifier. The digital elements are specified and constructed to achieve outstanding audio performance while maintaining a very low latency of 0.3 msec. The amplifiers are designed specifically for use with d&b loudspeakers, have remote control, monitoring capabilities and switch mode power supplies. To simplify configuration, the output mode of the amplifier can be configured as Dual Channel, Mix TOP/SUB or 2-Way Active modes depending on the application. The user definable equalization and delay functions incorporated in each channel of all d&b amplifiers are intended for tuning in applications such as infills, frontfills or under balcony delays, without the need for external processors. A signal generator offering pink noise or a sine wave program is also incorporated for test and alignment purposes.

d&b amplifiers¹ contain functions to allow system status monitoring and protection features, increasing the longevity of d&b systems. They provide the d&b System check function, which is designed to verify the system performs within a predefined condition; this can be used to report the system condition after a show. Input monitoring can detect incoming pilot tones to verify the integrity of the signal path to the amplifier, while the Load monitoring function determines the status of the loudspeaker impedance. Both d&b System check and Load monitoring can determine the status of an LF or HF driver in systems with multiple elements, even if these are crossed over passively. Automatic and continuous impedance monitoring, along with Input monitoring are designed for incorporation in applications specified to the

requirements of International Standard IEC 60849 'Sound Systems for Emergency Purposes'.

d&b amplifiers feature two control interfaces. Firstly, the front panel rotary encoder, combined with the display, provides full access to settings and functions. Secondly, by utilizing the d&b Remote network, the amplifiers can be remotely controlled and monitored from a virtual centre. Every amplifier channel can be assigned a unique channel and device name to simplify identification. The Wink function, which can be enabled remotely, flashes the display backlight to clearly identify specific amplifiers in a system. An integrated password protected LOCK function prevents unauthorized changes.

A powerCON² mains connector socket is fitted on the rear panel. The switch mode power supply of each amplifier incorporates mains overvoltage protection, inrush current limiting and loudspeaker protection at start up. Temperature and signal controlled fans cool the internal assemblies. d&b amplifiers offer analog and digital AES/EBU signal inputs, with link outputs for each channel. The AES/EBU link output carries a refreshed signal, while a power fail relay is incorporated to prevent interruption of the signal chain, in the event of a power failure.

The D12 amplifier incorporates d&b SenseDrive for accurate control of LF drivers in d&b loudspeakers driven 2-Way Active or in actively driven d&b subwoofers. When the D12 is fitted with EP5 connectors and appropriate 5-wire cabling, d&b SenseDrive can be used resulting in an extremely precise bass performance even at high levels. The LoadMatch function integrated within the D80 amplifier enables the electrical compensation of loudspeaker cable properties, without the need for an extra conductor. This results in an increased accuracy of audio reproduction over a bandwidth of up to 20 kHz preserving the tonal balance when cable lengths of up to 70 m (230 ft) are used.

Firmware updates containing new loudspeaker configurations or additional functions can be loaded to the amplifiers via the d&b Remote network.

Comparison of the D6, D12 and D80 amplifiers

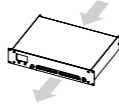
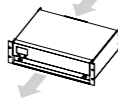
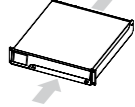
	D6	D12	D80
User interface	Encoder/LC display	Encoder/LC display	Encoder/colour TFT touchscreen
Output channels	2	2	4
Input channels	2 AES or analog	2 AES or analog	4 AES or analog
Latency	0.3 msec	0.3 msec	0.3 msec
User equalizers (per channel)	4-band	4-band	2 x 16-band
Delay	340 msec/116.9 m	340 msec/116.9 m	10 sec/3440 m
Rated output power	2 x 300 W into 8 ohms 2 x 600 W into 4 ohms (THD+N < 0.1%)	2 x 750 W into 8 ohms 2 x 1200 W into 4 ohms (THD+N < 0.1%)	4 x 2000 W into 8 ohms 4 x 4000 W into 4 ohms (THD+N < 0.5%, 12 dB crest factor)
Output routing	Dual Channel w/o B1 and B2	Dual Channel, Mix TOP/SUB 2-Way Active	Dual Channel, Mix TOP/SUB 2-Way Active
Output connectors	NL4	NL4/EP5/NL8	NL4/EP5 plus central NL8
Cable compensation	No	SenseDrive	LoadMatch
Mains voltage	Wide range switch mode power supply	100/200V or 120/230V	Wide range switch mode power supply
Weight (kg/lb)	8/17.6	13/28.7	19/42
Dimensions	2 RU x 19" x 353 mm	3 RU x 19" x 353 mm	2 RU x 19" x 530 mm
Remote	CAN	CAN	OCA via Ethernet/CAN
Airflow			

¹ At the time of print, certain functions required within applications specified to achieve compliance with IEC 60849 such as Input and Load monitoring are not implemented in the D80 amplifier, please contact your distributor for further information

² powerCON[®] is a registered trademark of the Neutrik AG, Liechtenstein

The operation with D6, D12 and D80 amplifiers

CUT mode

Set to CUT, the cabinet low frequency level is reduced and is configured for use with d&b active subwoofers.

HFC mode

Selecting the HFC (High Frequency Compensation) mode compensates for loss of high frequency energy due to absorption in air when loudspeakers are used to cover far field listening positions. HFC should be used selectively, only for those cabinets covering distances larger than 50 m (160 ft). This enables the correct sound balance between close and remote audience areas, whilst all amplifiers driving the array can be fed with the same signal.

HFA mode

In HFA mode (High Frequency Attenuation), the HF response of the system is rolled off. The HFA provides a natural, balanced frequency response when a unit is placed close to listeners in near field or delay use. High Frequency Attenuation begins gradually at 1 kHz, dropping by approximately 3 dB at 10 kHz. This roll off mimics the decline in frequency response experienced when listening to a system from a distance in a typically reverberant room or auditorium.

CPL function

The CPL (Coupling) function compensates for coupling effects between closely coupled cabinets by reducing the low and mid frequency level. CPL begins gradually at 1 kHz, with maximum attenuation below 400 Hz, providing a balanced frequency response when cabinets are used in arrays of two or more. The CPL function can be set in dB attenuation values between -9 and 0, or a positive CPL value which creates an adjustable low frequency boost around 65 Hz (0 to +5 dB).

100 Hz mode

The 100Hz mode limits the upper operating frequency of the subwoofer to 100Hz, complementing top cabinets in full range mode.

CSA mode

CSA (Cardioid Subwoofer Array) mode enables the combination of three or multiples of three subwoofer cabinets into an array that produces exceptional low frequency directivity control. The amplifier channel for the centre subwoofer of the column, which is physically pointed to the rear, has CSA selected. The forward facing cabinets are driven with an amplifier channel set in the standard mode. The resulting cardioid behaviour of the array will

significantly reduce the energy radiated to the rear. For further information please refer to the d&b T1330 Cardioid Subwoofer Array, which is available for download at www.dbaudio.com.

Maximum loudspeakers per D6, D12 or D80 channel

	Q1 Qi1	Q7 Qi7	Q10 Qi10	Q-SUB QiCSA -SUB	Qi-SUB
	2	2	2	2	2

D6, D12 and D80 controller settings

	Q1 Qi1	Q7 Qi7	Q10 Qi10	Q-SUB QiCSA -SUB	Qi-SUB
CUT	x	x	x		
HFC	x				
HFA		x	x		
CPL	x	x	x		
100 Hz				x	x
CSA				x	

The Q-Series frequency responses

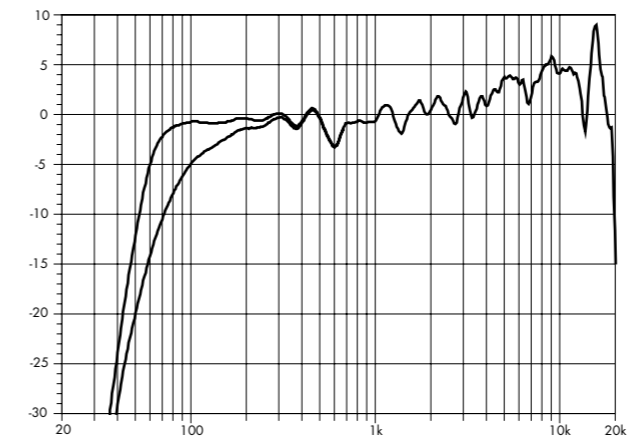

Q1 and Qi1 standard and CUT (single cabinet)

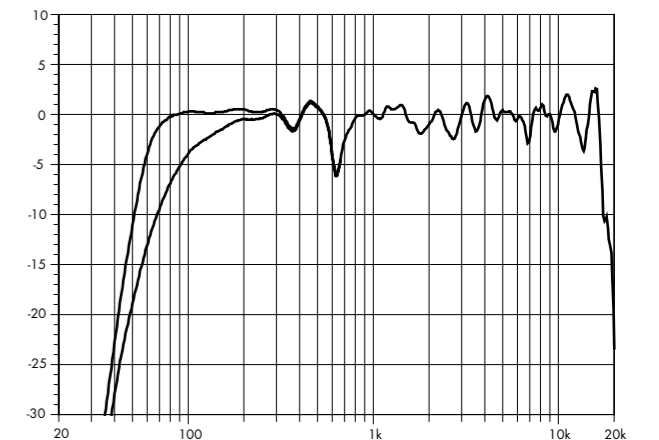

Q7 and Qi7 standard and CUT

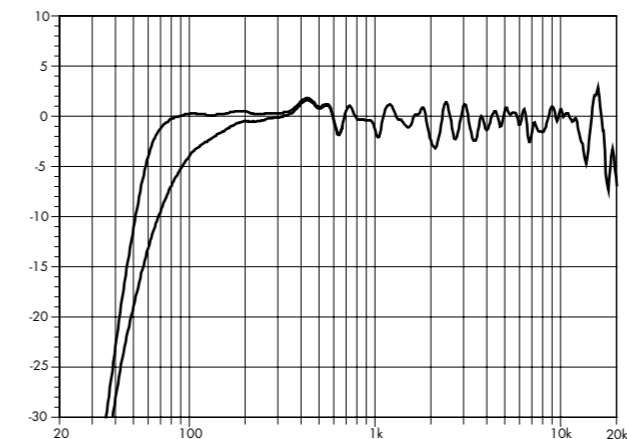

Q10 and Qi10 standard and CUT

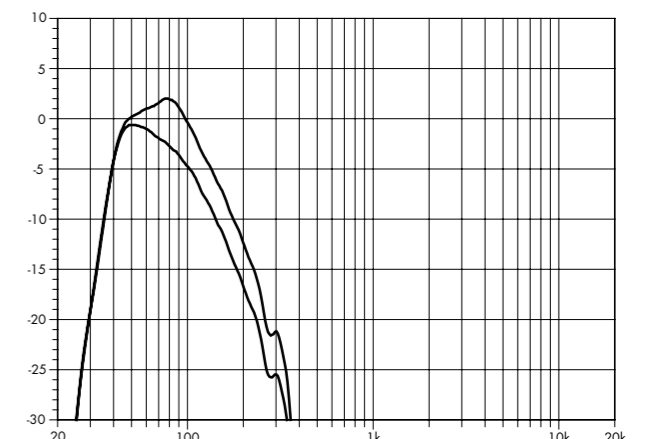

Q, Qi and QiCSA-SUB standard and 100 Hz

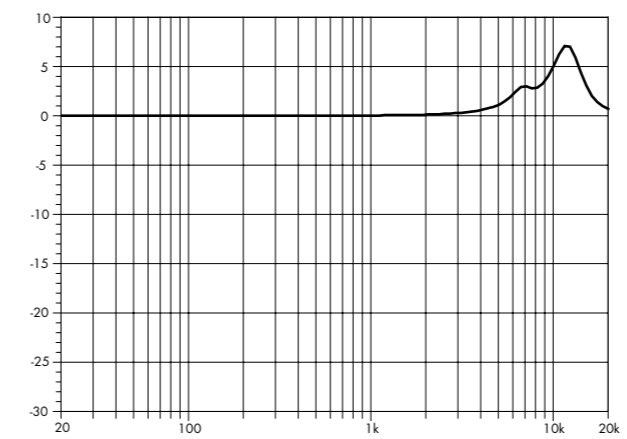

Correction of HFC

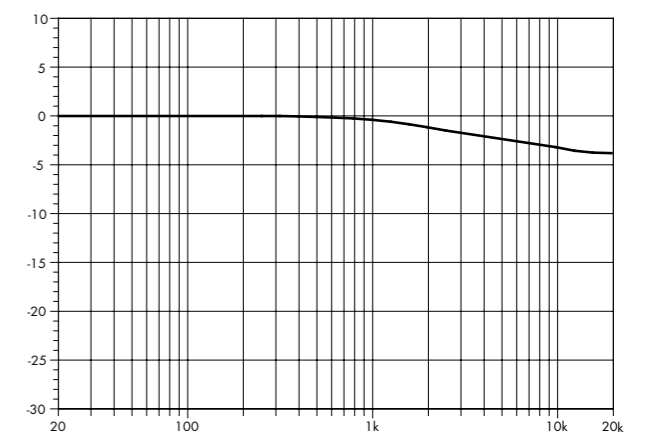

Correction of HFA

The d&b amplifier output modes

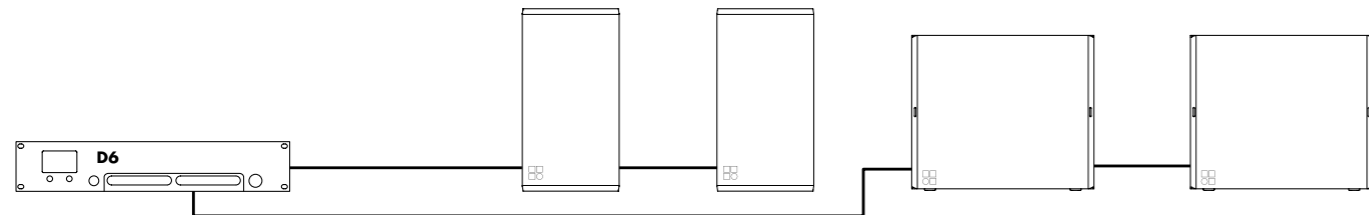

D6 amplifier in Dual Channel mode for Q7, Q10, Q1, Qi7, Qi10 or Qi1 and Q-SUB, Qi-SUB or QiCSA-SUB

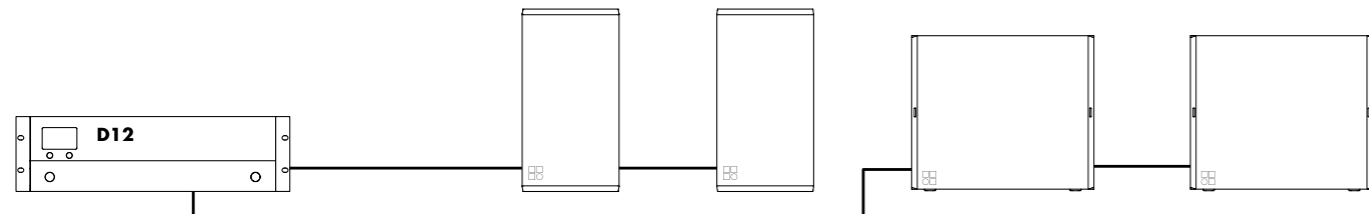

D12 amplifier in Dual Channel mode for Q7, Q10, Q1, Qi7, Qi10 or Qi1 and Q-SUB, Qi-SUB or QiCSA-SUB

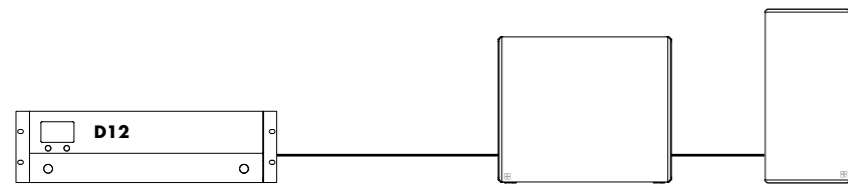

D12 amplifier in Mix TOP/SUB mode for Q7, Q10, Q1, Qi7, Qi10 or Qi1 and Q-SUB or Qi-SUB

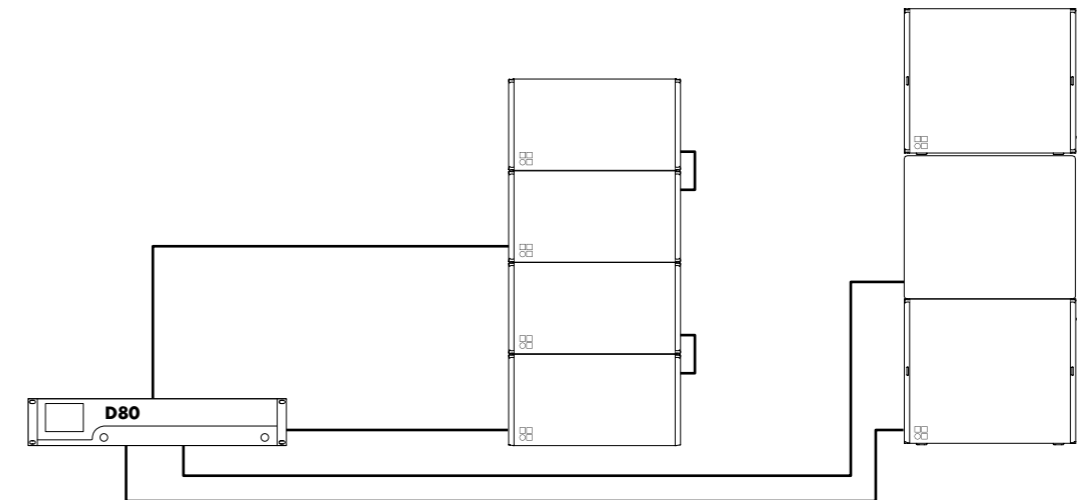

D80 amplifier in Dual Channel mode for Q7, Q10, Q1, Qi7, Qi10, Qi1, Q-SUB, Qi-SUB and QiCSA-SUB

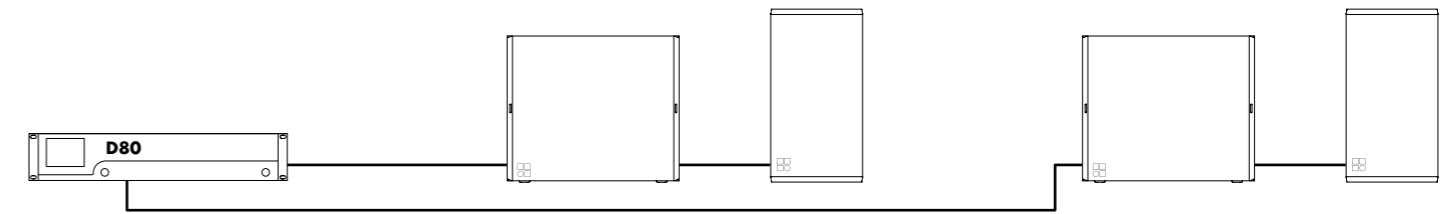

D80 amplifier in Mix TOP/SUB mode for Q7, Q10, Q1, Qi7, Qi10, Qi1, Q-SUB and Qi-SUB

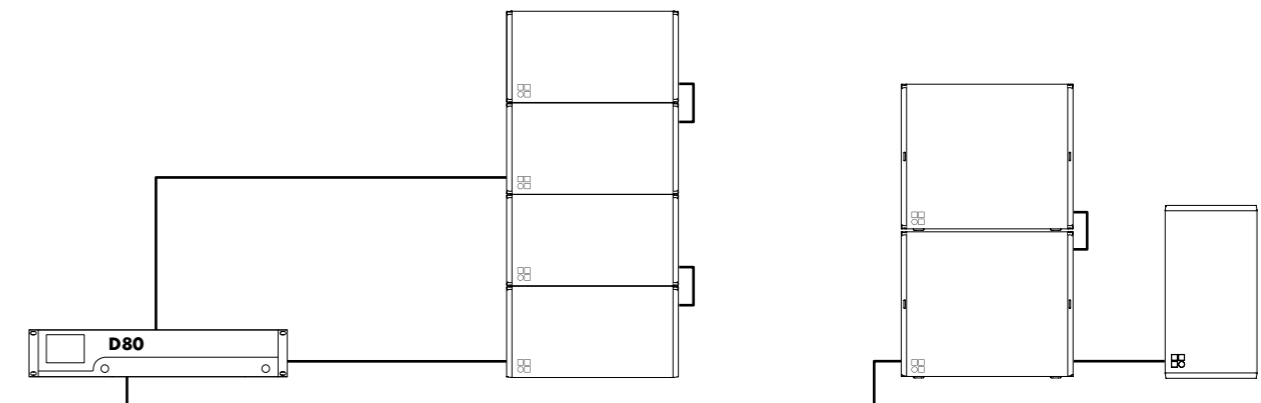

D80 amplifier in a mixed configuration of Dual Channel and Mix TOP/SUB modes for Q7, Q10, Q1, Qi7, Qi10, Qi1, Q-SUB and Qi-SUB

The Q-Series cables and adapters

Amplifiers in Dual Channel mode

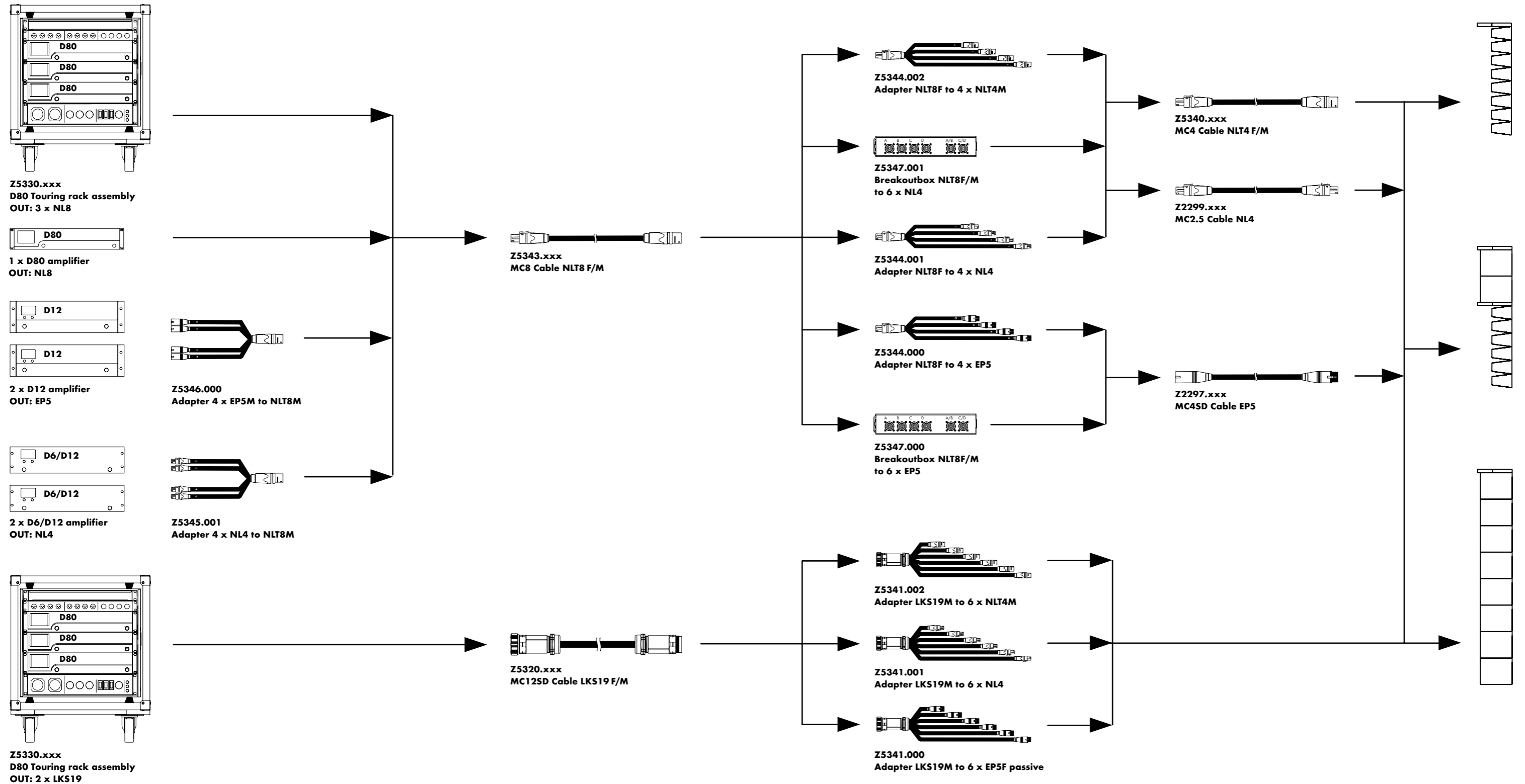

The Q-Series configuration examples

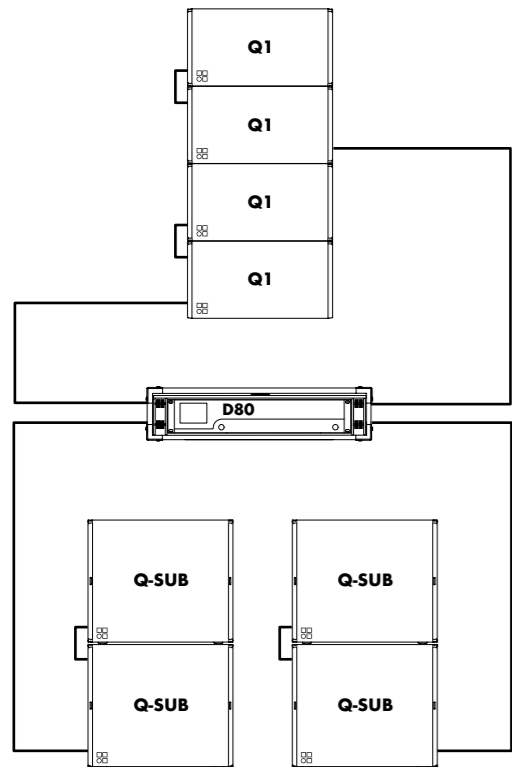

Q-Series configuration with flown Q1 line array and ground stacked Q-SUBs with D80 amplifier¹

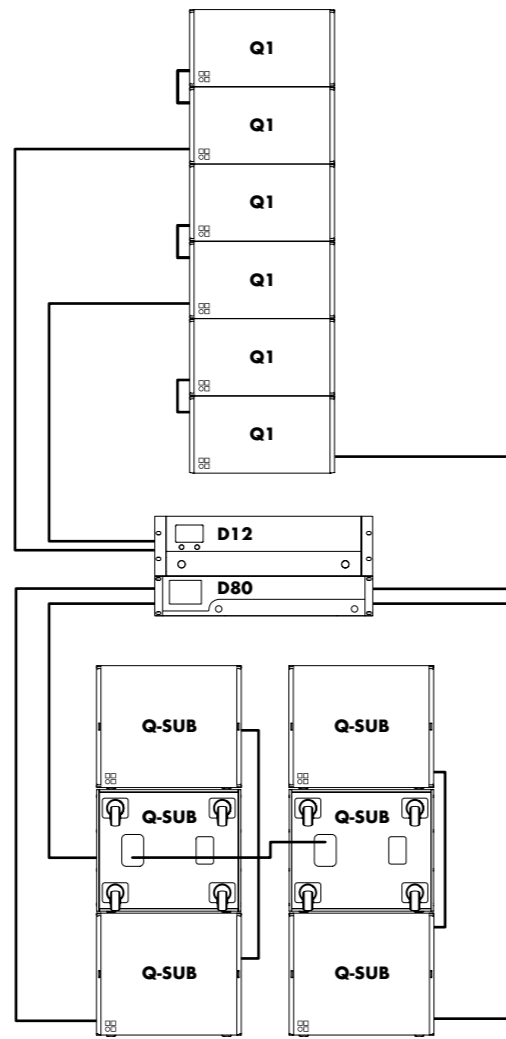

Q-Series configuration with flown Q1 line array with D12 amplifier and ground stacked Q-SUBs in CSA mode with D80 amplifier¹

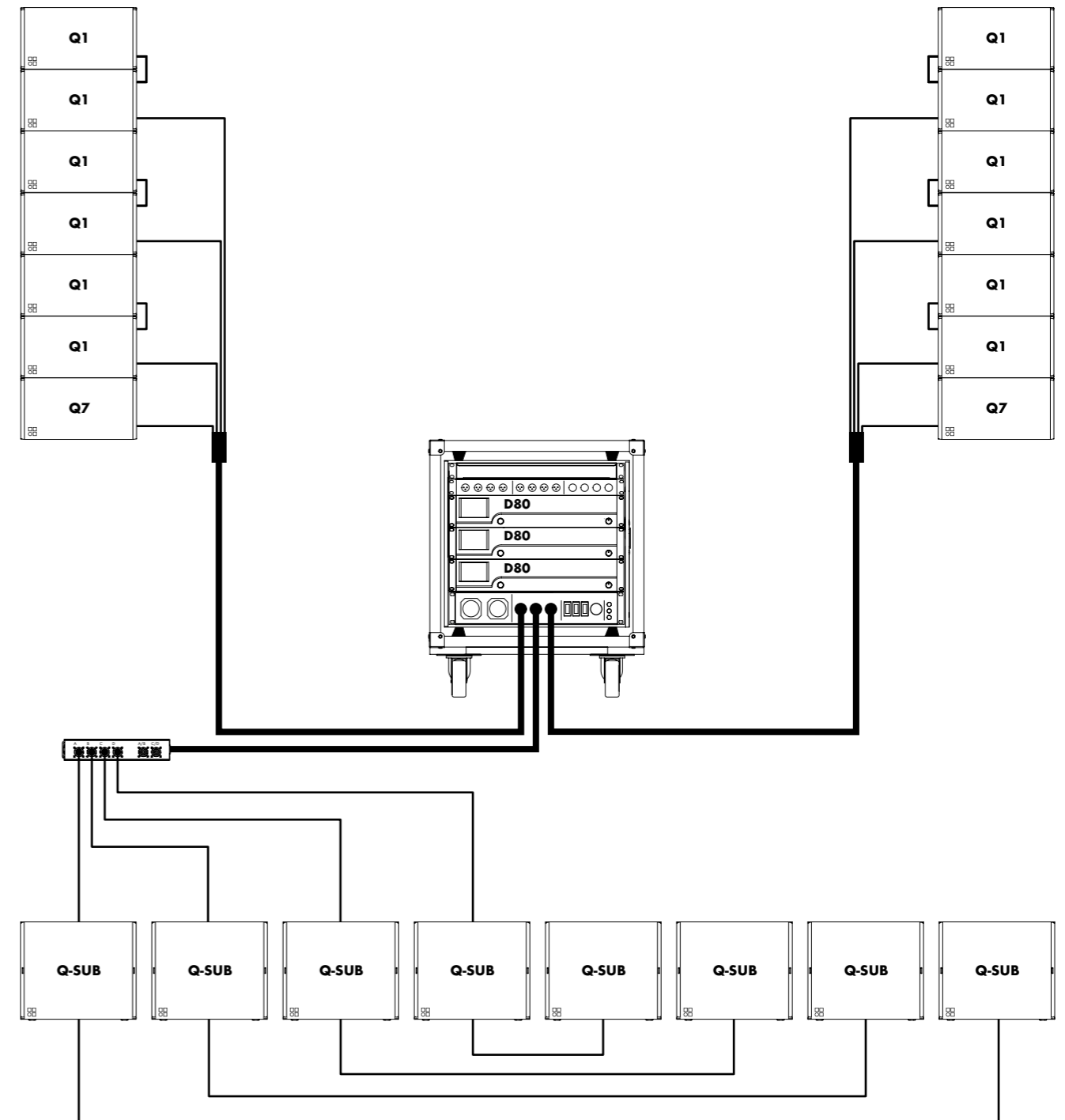

Q-Series L/R configuration with flown Q1 and Q7 line array and ground stacked Q-SUB array with D80 Touring rack¹

The Q-Series configuration examples

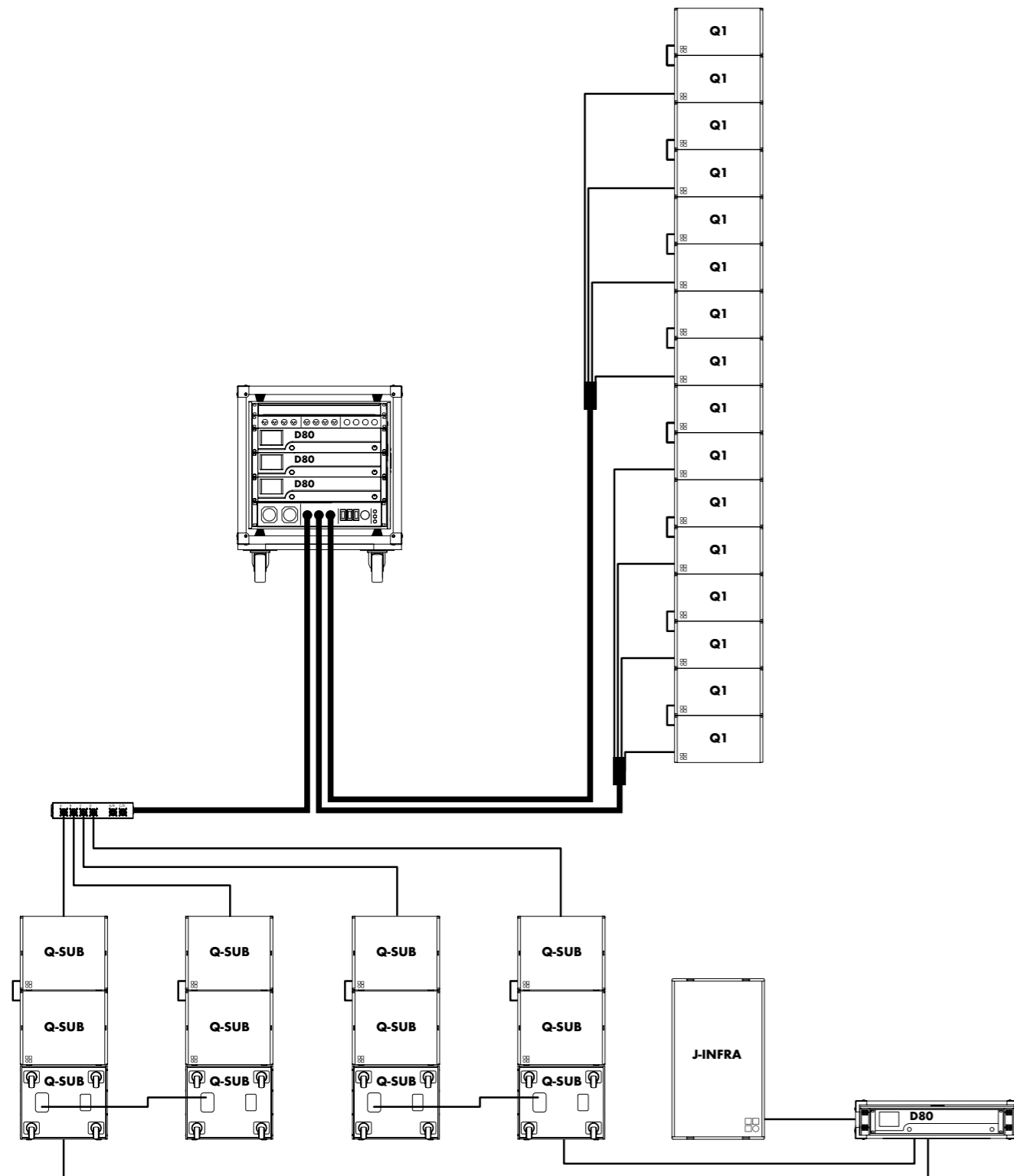

Q-Series configuration with flown Q1 line arrays and ground stacked Q-SUBs in CSA mode with D80 Touring rack and D80 amplifier¹

¹ These configuration examples are also valid for Qi loudspeakers

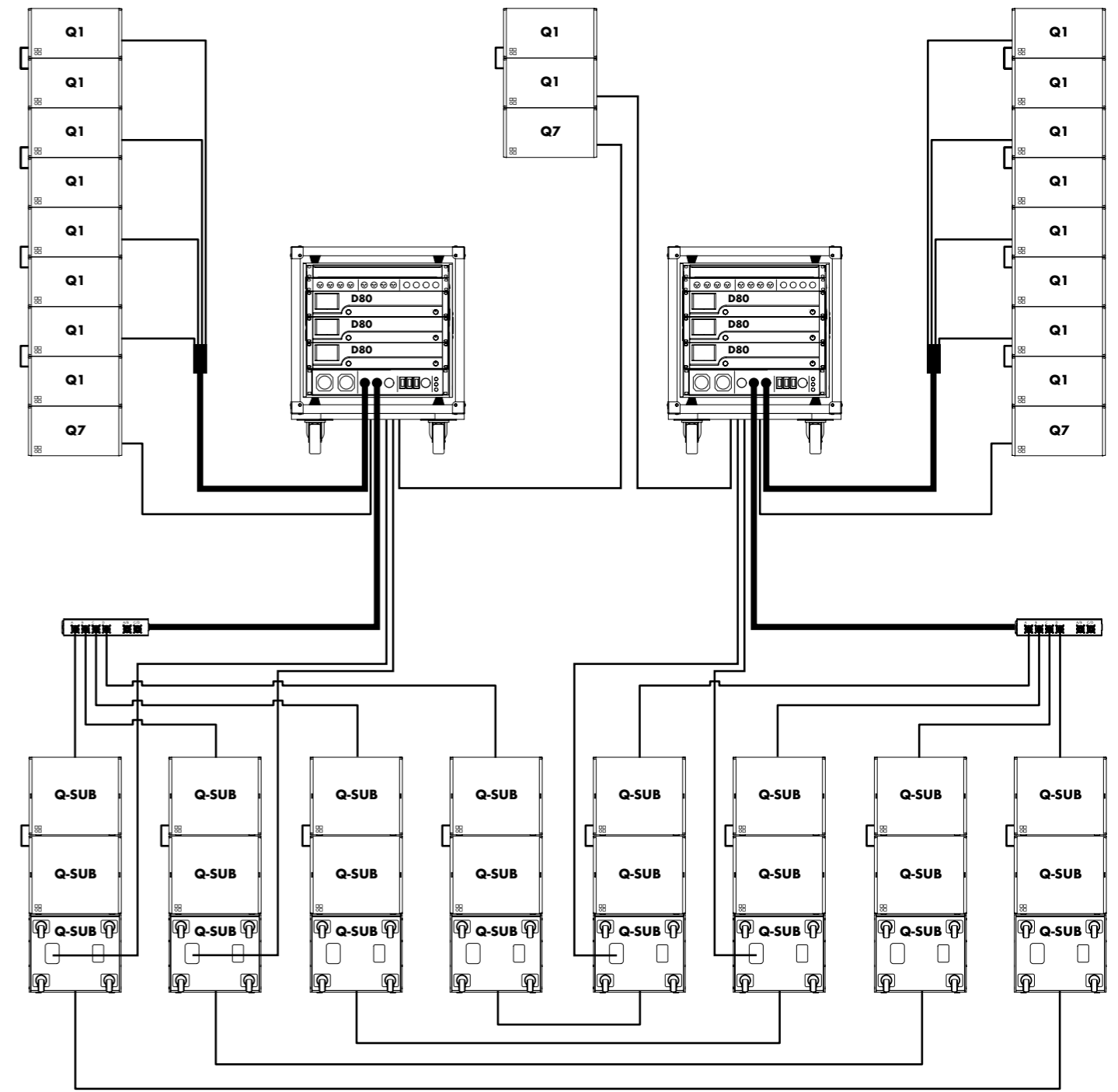

Q-Series L/R/C configuration with flown Q1 and Q7 line array and ground stacked Q-SUB sub array in CSA mode with D80 Touring racks¹

¹ These configuration examples are also valid for Qi loudspeakers

The Q-Series product overview

Q loudspeakers	Z0501.xxx Z0507.xxx Z0508.xxx Z0510.xxx	Q1 Loudspeaker ¹ Q7 Loudspeaker Q10 Loudspeaker Q Subwoofer	Z5147.001 Z5012.500 Z5024.000 Z5009.000 Z5013.000 Z5155.000 E6507.000 Q9032.000	Rota clamp Pipe clamp for TV spigot Loudspeaker stand adapter Loudspeaker stand with winder Loudspeaker stand winder M20 Q Hoist connector chain (supplied with 2 x E6507 1t Shackles) 1t Shackle Safety eyebolt M10
Loudspeaker connector options	Zxxxx.002 Zxxxx.000 Zxxxx.001	NLT4 F/M connector EP5 connector NL4 connector		
Qi loudspeakers	Z0521.000 Z0527.000 Z0528.000 Z0530.000 Z0531.000	Qi1 Loudspeaker NL4 connector Qi7 Loudspeaker NL4 connector Qi10 Loudspeaker NL4 connector Qi Subwoofer NL4 connector QiCSA Subwoofer NL4 connector WR Weather Resistant option ² SC Special Colour option ³	Remote network	R1 Remote control software ⁵ R60 USB to CAN interface R70 Ethernet to CAN interface RJ 45 M Terminator Bopla mounting clamp Bopla mounting clamp upright
Loudspeaker cases	E7430.000 E7431.000 E7432.000 E7433.000	Touring case 2 x Q1 / Q7 / Q10 wheels Touring case 3 x Q1 / Q7 / Q10 wheels Touring case 2 x Q1 / Q7 / Q10 wheels, Z5150 Q Swivel bracket, tray Touring case 2 x Q Flying frame wheels, flexible cable store, 2 trays	Amplifiers	D6 Amplifier NL4 D12 Amplifier ⁶ D80 Amplifier ⁶
Lids	E7921.000	Q-SUB Wooden lid	Amplifier rack assemblies	D80 Touring rack assembly, CEE 32A 5P ⁷ D80 Touring rack assembly, Nema L21-30 (120V devices) on request ⁷
Q accessories	Z5154.000 Z5151.000 Z5152.000 Z5153.000 Z5159.000 Z5160.000 Z5150.000 Z5156.000 Z5048.000	Q Rigging set (supplied with Q1 includes 2 x Z5151, Z5152 and 4 x Z5153) Q Splay link Q Front link Locking pins 8 mm (linked in pairs with steel wire) Q Flying frame Q Load adapter Q Swivel bracket Q Flying adapter Flying pin 10 mm	Amplifier racks	D80 Touring rack 2 RU, 19" SD , shock mounted, handles, window Touring rack 3 RU, 19" DD , shock mounted, handles, window Touring rack 6 RU, 19" DD , shock mounted, handles, window, wheels
Qi accessories	Z5145.000 Z5170.000 Z5171.000 Z5172.000 Z5054.000 Z5053.000	Ci/Qi Mounting frame ³ Qi Mounting adapter ^{3, 4} Qi Mounting plate ^{3, 4} Qi-SUB Mounting plate ^{3, 4} Ci60/Ci90 Flying adapter ³ Ci60/Ci90 Bracket connector	Cables	MC8 Cable NLT8 F/M Adapter 4 x EP5M to NLT8M Adapter 4 x NL4 to NLT8M MC12SD Cable LKS19 F/M Adapter NLT8F to 4 x NLT4M Adapter NLT8F to 4 x NL4 Adapter NLT8F to 4 x EP5 Breakoutbox NLT8 F/M to 6 x NL4 Breakoutbox NLT8 F/M to 6 x EP5 MC4 Cable NLT4 F/M MC2.5 Cable NL4 MC4SD Cable EP5 Adapter LKS19 M to 6 x NLT4M Adapter LKS19 M to 6 x NL4 Adapter LKS19M to 6 x EP5
Q/Qi accessories	Z5161.000 Z5175.000 Z5044.000 Z5020.000 Z5025.000 Z5015.000 Z5010.000	Q Flying bracket ³ Qi Horizontal bracket MAX Bracket connector ⁴ Flying adapter 02 ³ Flying adapter 03 ³ TV spigot for flying adapter 02 TV spigot with fixing plate	Miscellaneous	Anti-slip coating 1 kg / 2.2 lb Standard cabinet paint 1 kg / 2.2 lb

¹ supplied including Z5154 Q Rigging set

² WR only for Qi loudspeakers, on request

³ SC only for Qi loudspeakers, on request

⁴ supplied in pairs

⁵ available as a download at www.dbaudio.com

⁶ the complete list of amplifier versions is available in the d&b Amplifier and Software brochure

⁷ further information is available in the d&b Amplifier and Software brochure

