

► Blustream Multicast

ACM200 - Advanced Control Module User Manual

Thank you for purchasing this Blustream product

For optimum performance and safety, please read these instructions carefully before connecting, operating or adjusting this product. Please keep this manual for future reference.

Surge protection device recommended

This product contains sensitive electrical components that may be damaged by electrical spikes, surges, electric shock, lightning strikes, etc. Use of surge protection systems are highly recommended in order to protect and extend the life of your equipment.

Safety and performance notice

Do not substitute or use any other power supply other than approved PoE network products or approved Blustream power supplies.

Do not disassemble the ACM200 unit for any reason. Doing so will void the manufacturer's warranty.

Contents

Introduction	03
Features	03
Panel Descriptions - ACM200	04
ACM200 Control Ports	05
ACM200 Control Ports - IR Control	06
ACM200 Network Connection - Schematic Diagram	07
Web-GUI - Sign In / Log In	08
Web-GUI - New Project Set-up Wizard	09 - 13
Web-GUI - Menu Overview	14
Web-GUI - Drag & Drop Control	15
Web-GUI - Video Wall Control	16
Web-GUI - Preview	17
Web-GUI - Project Summary	18
Web-GUI - Transmitters	19 - 21
Web-GUI - Receivers	22 - 23
Web-GUI - Fixed Signal Routing	24 - 26
Web-GUI - Video Wall Configuration	27 - 32
Web-GUI - Users	33 - 34
Web-GUI - Settings	35 - 36
Web-GUI - Update Firmware	37 - 39
Web-GUI - Update Admin Password	39
RS-232 Serial Routing	40
Specifications, Package Contents & Maintenance	41
Blustream IR, RS-232 & Telnet Commands	42 - 48
Troubleshooting	49
Computer Settings - enabling TFTP & Telnet	50 - 53

Introduction

The UHD Multicast distribution platform allows distribution of HDMI video over a 1Gb Network switch. The ACM200 Control Module allows advanced third party control of the Multicast system using TCP / IP, RS-232 and IR.

The ACM200 includes a web interface module for control and configuration of the Multicast system and features 'Drag & Drop' source selection with media preview and independent routing of Video, Audio, IR, RS-232, and USB / KVM.

Pre-built Blustream product drivers simplify Multicast product installation and negate the need for an understanding of complex network infrastructures.

Features

- Web interface module for configuration and control of the Blustream Multicast system
- Intuitive 'Drag & Drop' source selection with video preview feature for active monitoring of system status
- Advanced signal management for independent routing of Video, Audio, IR, RS-232, and USB/KVM
- Auto system configuration
- 2x RJ45 LAN connections to bridge existing network to Multicast video distribution network, resulting in:
 - Better system performance as network traffic is separated
 - No advanced network setup required
 - Independent IP address per LAN connection
 - Allows simplified TCP / IP control of Multicast system
- RS-232 integration for control of Multicast system
- IR integration for control of Multicast system
- PoE (Power over Ethernet) to power ACM200 from PoE switch
- Local 12V power supply (optional) should switch not support PoE
- Support for iOS and Android App control (not available at initial release)
- 3rd party drivers available for major home control brands

Important Note:

The Blustream Multicast system distributes HDMI video over Layer 3 Managed network hardware. It is advised that Blustream Multicast products are connected on an independent network switch to prevent unnecessary interference, or reduction in signal performance due to other network products bandwidth requirements.

Please read and understand the instructions in this manual and ensure that the network switch is configured correctly prior to connecting any Blustream Multicast products. Failure to do so will result in problems with configuration of the system and video performance.

Panel Descriptions - ACM200

ACM200 - Front Panel

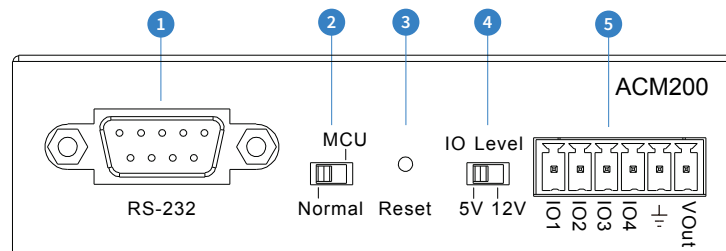

ACM200 - Rear Panel

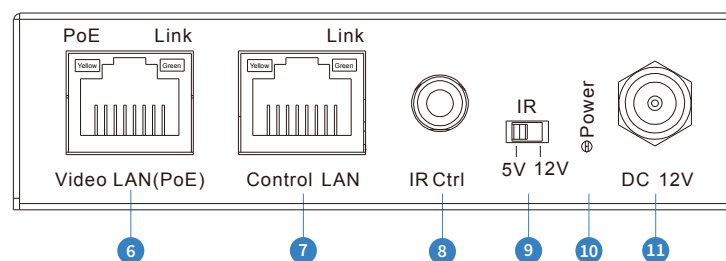

- 1 RS-232 control port – connect to a third party control device for control of the Multicast system using RS-232.
- 2 MCU Upgrade toggle - use when upgrading MCU firmware only. **Leave in normal position for standard operation.**
- 3 Reset - short press resets the ACM200, long press (10 seconds) factory defaults the ACM200.
- 4 IO Level switch - reserved for future use.
- 5 IO Level phoenix - reserved for future use.
- 6 Video LAN (PoE) - connect to the network switch that the Blustream Multicast components are connected to.
- 7 Control LAN port - connect to existing network that a third party control system resides on. The Control LAN port is used for Telnet/IP control of the Multicast system. Not PoE.
- 8 IR Ctrl (IR input) – 3.5mm stereo jack. Connect to third party control system if using IR as the chosen method of controlling the Multicast system. When using the included 3.5mm stereo to mono cable, ensure the cable direction is correct.
- 9 IR - adjust IR voltage level between 5V or 12V input for IR Ctrl.
- 10 Power LED indicator
- 11 Power port – use 12V 1A DC adaptor (sold separately) if not using a PoE network switch.

ACM200 Control Ports

The ACM200 communication ports are located on both end panels and include the following connections:

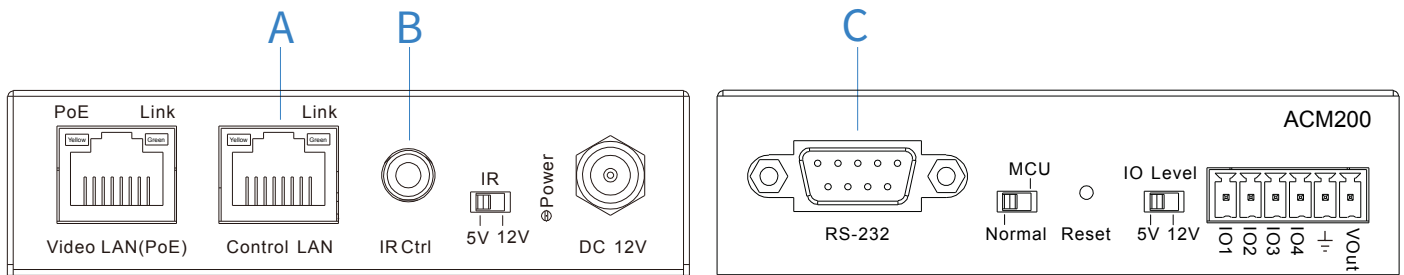

Connections:

- A. TCP/IP – for full Multicast system control (RJ45 Connector)
- B. Infrared (IR) Input* - 3.5mm stereo jack - For Multicast switching control only
- C. RS-232 – for full Multicast system control / RS-232 pass-through (DB9)

* **Please note:** the ACM200 can be used with both 5V and 12V IR line systems. Please ensure that the switch (adjacent to the IR port) is correctly selected to the specification of the IR line input.

TCP/IP:

The Blustream ACM200 can be controlled via TCP/IP.

For the full list of protocols please see ‘RS-232 & Telnet Commands’ located towards the rear of this manual.

A ‘straight-through’ RJ45 patch lead should be used when connected to a network switch.

Control Port: [23](#)

Default IP: [192.168.0.225](#)

Default Username: [admin](#)

Default Password: [1 2 3 4](#)

RS-232:

The Blustream ACM200 can be controlled via serial using the serial DB9 connector. Default settings below:

For the full list of command protocols please see ‘RS-232 & Telnet Commands’ located at towards rear of this manual.

Baud Rate: [57600](#)

Data Bit: [8-bit](#)

Parity: [None](#)

Stop Bit: [1-bit](#)

Flow Control: [None](#)

The Baudrate for the ACM200 can be adjusted using the ACM200 built-in web-GUI, or by issuing the following command via RS-232 or Telnet:

RSB x : Set RS-232 Baud Rate to X bps

Where X= 0 : 115200

1 : 57600

2 : 38400

3 : 19200

4 : 9600

ACM200 Control Ports - IR Control

The Multicast system can be controlled using local IR control from a third party control system. Source selection is the only feature available when using local IR control - advanced features of the ACM200 such as video wall mode, audio embedding etc. can only be achieved using RS-232 or TCP/IP control.

Blustream have created 16x input & 16x output IR commands allowing source selection of up to 16x IPxxxUHD-TX Transmitters on up to 16x IPxxxUHD-RX Receivers. For systems larger than 16x source devices (IPxxxUHD-TX) RS-232 or TCP/IP control will be required.

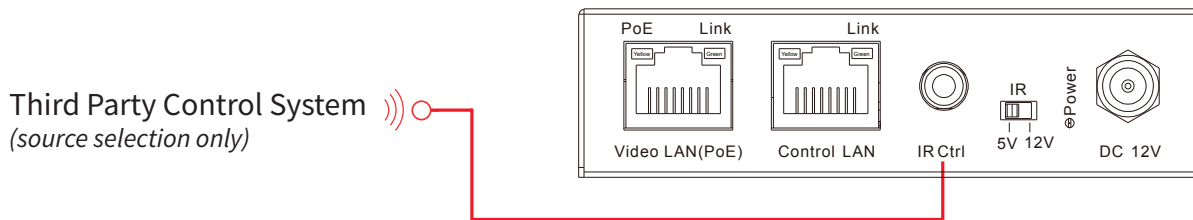

The ACM200 is compatible with both 5V and 12V IR equipment. When the ACM200 is being used to receive an IR input into the IR Ctrl port, the adjacent switch must be toggled correctly to suit the IR voltage line of the chosen control system before connection.

Please note: Blustream IR cabling is all 5V

3.5mm Stereo to Mono Cable - IR-CAB (included)

Blustream IR Control cable 3.5mm Mono to 3.5mm Stereo for linking third party control solutions to Blustream products.

Compatible with 12V IR third party products.

Please note: Cable is directional as indicated

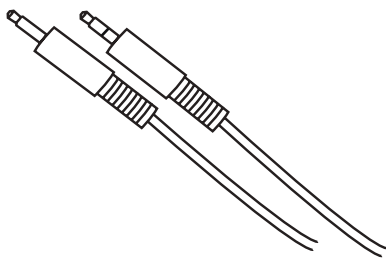

Wiring pin - IR-CAB - stereo 3.5mm jack:

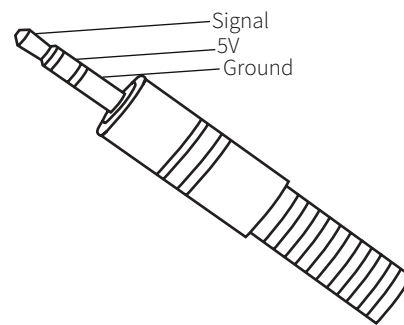

IR Receiver - IRR - stereo 3.5mm jack (optional)

Blustream 5V IR receiver to receive an IR signal and distribute through Blustream products

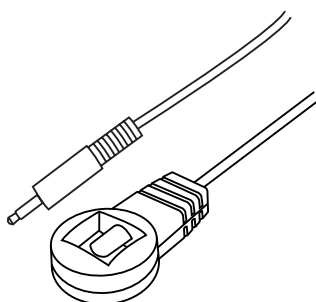

Wiring pin - IR-CAB - mono 3.5mm jack:

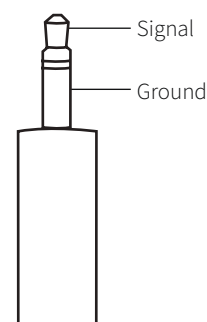

ACM200 Network Connection

The ACM200 acts as a bridge between the control network and video network to ensure that the data travelling between the two networks are not mixed. The ACM200 must be connected via CAT cable up to 100m in length in accordance with typical networking requirements.

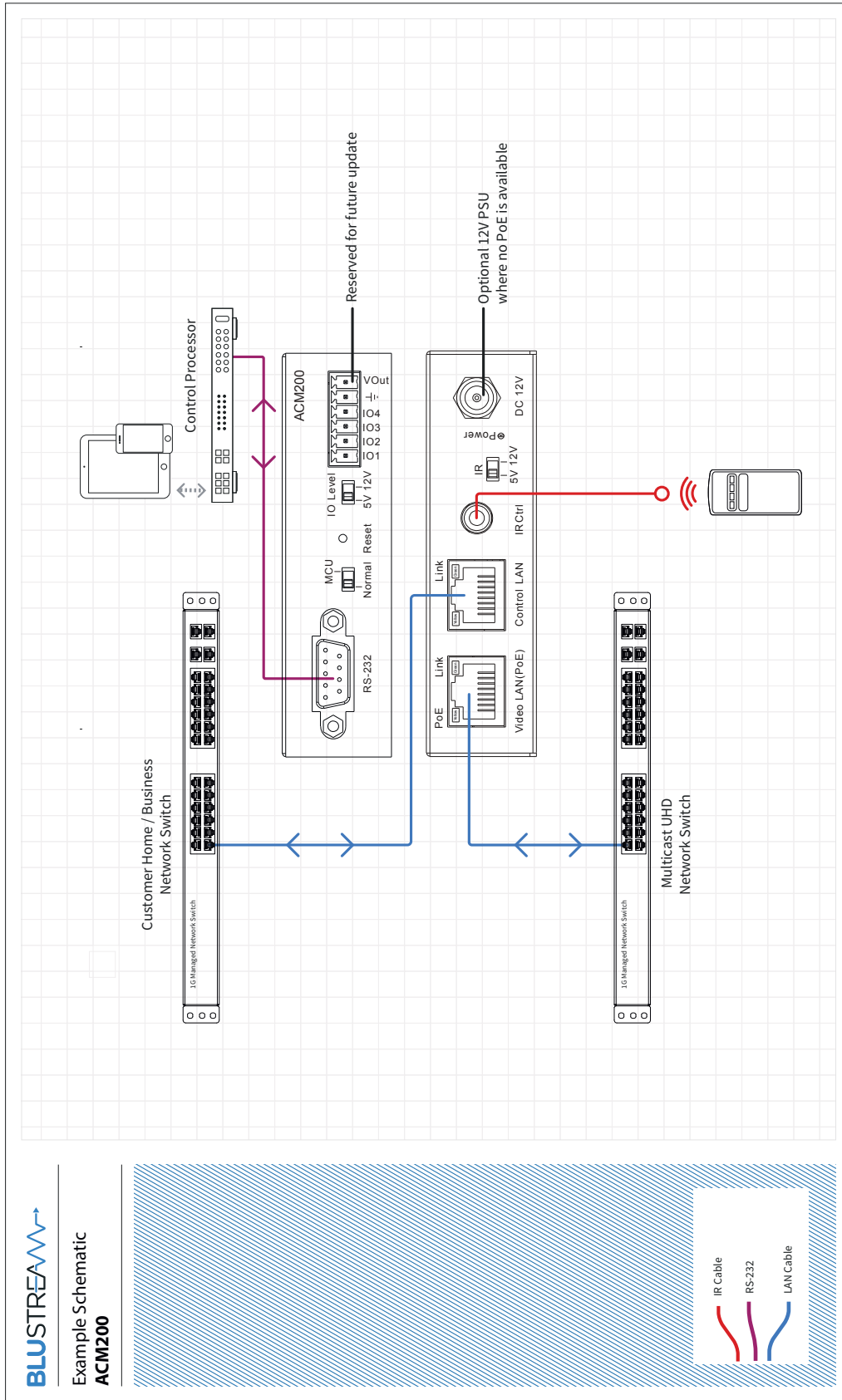

Web-GUI Guide

The web-GUI of the ACM200 allows for full configuration of a new system, as well as on-going maintenance and control of an existing system through a web portal. The ACM200 can be accessed on any internet connected device including: tablets, smart phones and laptops that are on the same network.

Sign In / Log In

Before logging in to the ACM200, ensure that the control device (i.e. laptop / tablet) is connected to the same network as the ACM200's Control Port. There are instructions of how to amend the static IP address of a PC at the rear of this manual.

To log in, open a web browser (i.e. Firefox, Internet Explorer etc.) and navigate to the default static IP address of the ACM200 which is:

192.168.0.225

Please note: the ACM200 is shipped with a static IP address.

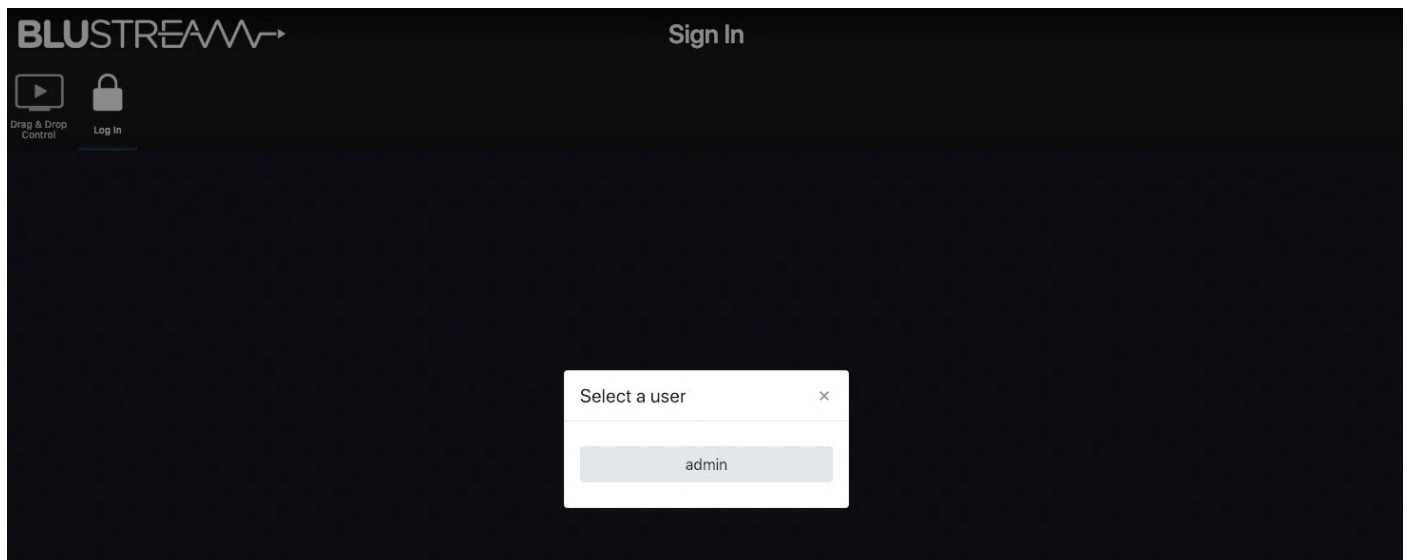

The sign in page is presented on connection to the ACM200. Once Users have been created within the system, this screen will be populated with the Users previously configured for future log ins. The default admin PIN is:

1 2 3 4

Please note: the default admin password can be changed once logged in using the 'Update Password' feature

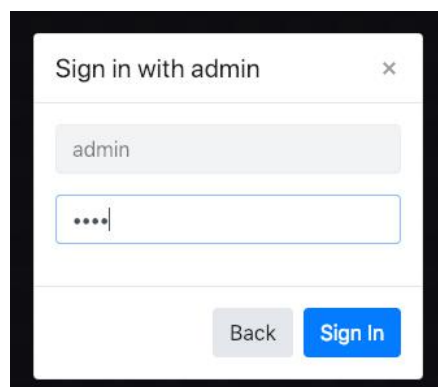

New Project Set-up Wizard

On first log in of the ACM200, a Set-up Wizard for configuring all components of the Multicast system will be presented. This has been designed to speed up new system configuration as all default / new Multicast Transmitters & Receivers can be connected to the network switch at the same time, whilst not resulting in an IP conflict during the system configuration. This results in a system in which all components are automatically and sequentially assigned a name and IP address ready for basic system use.

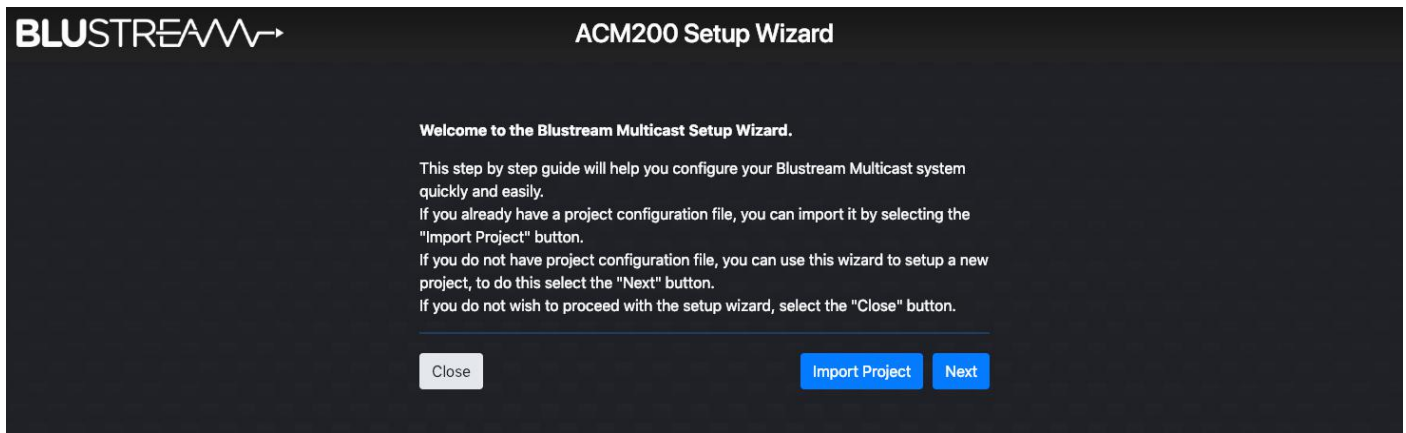

The ACM200 Set-up Wizard can be cancelled by clicking 'Close'. Please be aware that the system will not be configured at this point, but can be continued by visiting the 'Project' menu (see page 18). If a project file is already available (i.e. replacing an ACM200 on an existing site), this can be imported by using the .json file by clicking 'Import Project'.

Click 'Next' to continue set-up:

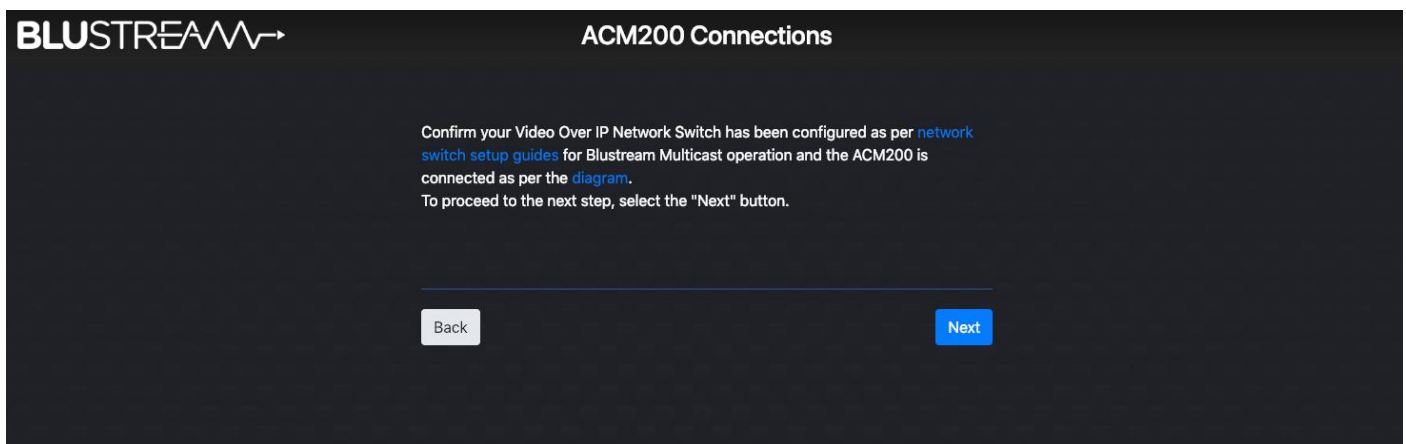

If at this point the Network Switch is not configured for use with the Blustream Multicast system, click on the hyperlink 'network switch setup guides' to navigate to a centralised webpage containing common Network Switch Guides.

An example schematic diagram for the connections of the ACM200 can be accessed by clicking the hyperlink marked 'diagram'. This will ensure the ACM200 is connected correctly to the wider Multicast system before the Set-up Wizard begins. Once the connections of the ACM200, are confirmed click 'Next'. The connections diagram is included on page 07 of this guide.

New Project Set-up Wizard - continued...

We are now ready to add Multicast devices to your project. There are two ways you can have devices added to your system.

Method 1 - Connect all Transmitter and Receiver devices to the video network switch before you begin your scan. This method is the quickest and simplest setup procedure however once complete you will need to identify your devices as this will auto-assign product IDs.

Method 2 - Connect each Transmitter and Receiver device to the network one by one. The setup wizard will configure the products as the next input or output device meaning that you are in control of the IDs that are allocated to each product.

When you are ready to add devices to your project, click the "Start Scan" button. The devices, as they are found, will show up in the list below. Once all of your transmitters and receivers are shown in the list (check the total numbers of RX and TX found and configured) you can click the "Stop Scan" button. When you are ready to proceed to the next step, select the "Next" button.

Transmitters			Receivers		
ID	Name	IP Address	ID	Name	IP Address
There are no transmitters found			There are no receivers found		

There are two methods for adding new Multicast Transmitter and Receiver devices to a system, please choose one before clicking 'Start Scan':

Method 1: connect **ALL** Blustream Multicast Transmitter and Receiver units to the network switch with their factory default IP addresses (169.254.100.254). This method will quickly configure all devices with their own individual IP addresses based on the following:

Transmitters:

The first Transmitter will be given the IP address of 169.254.3.1. The next Transmitter will be assigned an IP address of 169.254.3.2 and so on...

Once the IP range of 169.254.3.x is filled (254 units), the software will auto assign an IP address of 169.254.4.1 and so on...

Once the IP range of 169.254.4.x is filled the software will auto assign an IP address of 169.254.5.1 and so on until 169.254.4.254

Receivers:

The first Receiver will be given the IP address of 169.254.6.1. The next Receiver will be assigned an IP address of 169.254.6.2 and so on....

Once the IP range of 169.254.6.x is filled (254 units) the software will auto assign an IP address of 169.254.7.1 and so on...

Once the IP range of 169.254.7.x is filled the software will auto assign an IP address of 169.254.8.1 and so on until 169.254.8.254

Once complete, devices will need to be identified manually - this method will auto-assign product IP addresses and ID's to each device connected to the network switch randomly (not by switch port).

Method 2: connect each Blustream Multicast Transmitter and Receiver to the network one-by-one. The Set-up Wizard will configure the units sequentially as they are connected / found. This method allows for the control of the sequential assigning of IP addresses and ID's of each product - the Transmitter / Receiver units can therefore be labelled accordingly.

New Project Set-up Wizard - continued...

Once the set-up method to configure the system has been chosen, hit the 'Start Scan' button.

The ACM200 will search for new Blustream Multicast units on the network and will continue to search for new devices until such time as:

- The 'Stop Scan' button is pressed
- The 'Next' button is clicked to progress the Set-up Wizard after all units have been found

The screenshot shows the 'Project Setup' screen of the Blustream interface. It contains instructions for adding multicast devices, two methods for connection, and a table for discovered transmitters and receivers. A 'Stop Scan' button is visible in the top right, and 'Back' and 'Next' buttons are at the bottom.

BLUSTREAM Project Setup

We are now ready to add Multicast devices to your project. There are two ways you can have devices added to your system.

Method 1 - Connect all Transmitter and Receiver devices to the video network switch before you begin your scan. This method is the quickest and simplest setup procedure however once complete you will need to identify your devices as this will auto-assign product IDs.

Method 2 - Connect each Transmitter and Receiver device to the network one by one. The setup wizard will configure the products as the next input or output device meaning that you are in control of the IDs that are allocated to each product.

When you are ready to add devices to your project, click the "Start Scan" button. The devices, as they are found, will show up in the list below. Once all of your transmitters and receivers are shown in the list (check the total numbers of RX and TX found and configured) you can click the "Stop Scan" button. When you are ready to proceed to the next step, select the "Next" button.

Stop Scan

Transmitters			Receivers		
ID	Name	IP Address	ID	Name	IP Address
1	Transmitter 001	169.254.3.1	There are no receivers found		
2	Transmitter 002	169.254.3.2			

Back **Next**

As new units are found by the ACM200, the units will populate to the relevant columns marked Receivers or Transmitters. It is recommended to label the individual units at this point.

Once all units have been found and configured, click 'Stop Scan', then 'Next'.

New Project Set-up Wizard - continued...

The Device Set-up page allows for Transmitters and Receivers to be named accordingly. EDID and Scaler settings for the individual Transmitters or Receivers can be set as required. For help with EDID and Scaler settings, click the relevant buttons marked 'EDID Help' or 'Scaling Help', refer to page 24.

BLUSTREAM **Device Setup**

Configure your Transmitters and Receivers as required:

1. Customise the name for each device.
2. Specify an EDID for each Transmitter.
3. Configure the scaler output resolution for each Receiver.

Once configured the Multicast Receivers will automatically display their unique product identity on screen
To help identify the Multicast Transmitter products each Transmitter has a 'VIEW' button. Once pressed a preview video window of the source will be displayed.
For additional information select the "Scaling Help" or "EDID Help" button.
Note: Some devices may still be restarting from the initial setup, you will have to wait for these devices to restart before updating them.
When you are ready to proceed to the next step, select the "Next" button.

EDID Help OSD Help

Turn OSD Off Scaling Help

Transmitters				Receivers			
ID	Name	EDID		ID	Name	Scaler Resolution	
1	Transmitter 001	Default EDID	View	1	Receiver 001	Pass Through	Actions
2	Transmitter 002	Default EDID	View	2	Receiver 002	Pass Through	Actions
3	Transmitter 003	Default EDID	View	3	Receiver 003	Pass Through	Actions

Back Next

Features of the Device Set-up page include:

- 1. Name of Devices** - during configuration the Transmitters / Receivers are automatically assigned default names i.e. Transmitter 001 etc. Transmitter / Receiver names can be amended by typing in the corresponding box.
- 2. EDID** - fix the EDID value for each Transmitter (source). This is used to request specific video and audio resolutions for the source device to output. Basic help with EDID selection can be obtained by clicking the button marked 'EDID Help'. See page 19 for a full list of EDID settings that can be applied.
- 3. View** - opens the following pop-up:

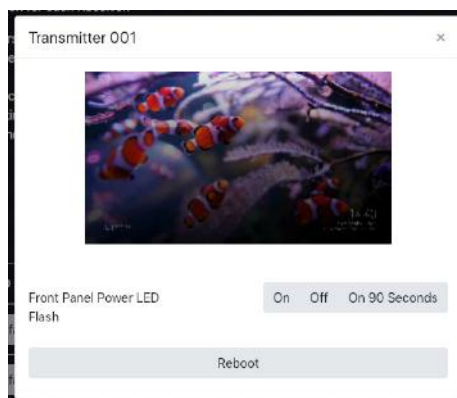

This pop-up shows an image preview of the media currently being streamed by the Transmitter unit. The ability to identify the unit by flashing the front panel LED's on the unit, and the ability to Reboot the unit.

New Project Set-up Wizard - continued...

- 4. Scaler** - adjust the output resolution using the built-in video scaler of the Multicast Receiver. The scaler is capable of both upscaling and downscaling the incoming video signal. See page 22 for a full list of Scaler output settings that can be applied.
- 5. Refresh** - click here to refresh all current information on the products within the system.
- 6. Actions** - opens the following pop-up:

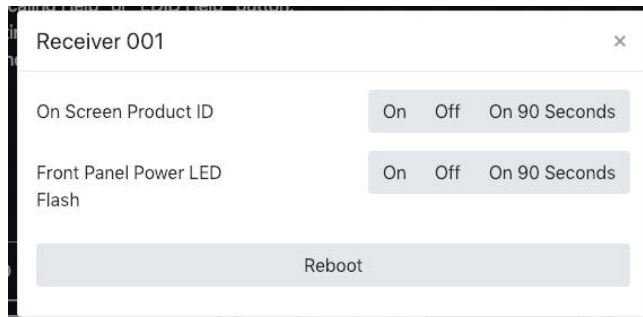

This pop-up gives you the ability to display the product ID on the connected screen / display by way of an OSD (On Screen Display) as an overlay to the media being accepted by the Receiver. The ability to identify the unit by flashing the front panel LED's, and the ability to Reboot the unit is contained here.

- 7. Turn OSD On / Off** - toggles the product ID onto the connected screen / display by way of an OSD.

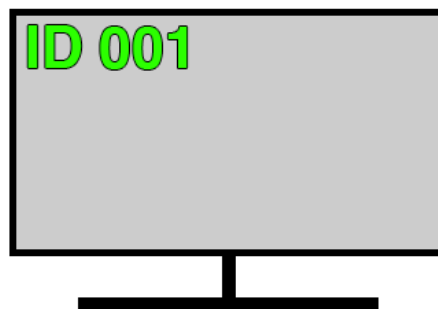

- 8. Next** - continues to the Set-up Wizard Completion page

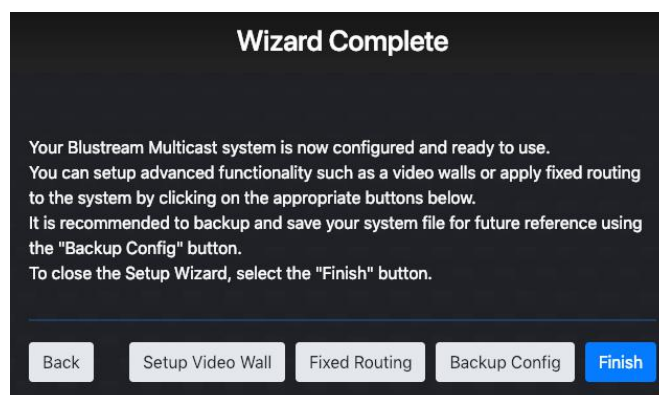

The Wizard Completion page finalises the basic configuration process and provides links for advanced set-up options for Video Walls, Fixed Signal Routing (IR, RS-232, Audio etc), and the ability to back-up to a configuration file (*recommended*).

Click 'Finish' once done to continue to the 'Drag & Drop Control' page, logged in as Administrator (see page 15).

Web-GUI - Menu Overview

The '**User Interface**' menu gives an end user the ability to switch and preview the Multicast system without allowing access to any settings that can change the overall infrastructure of the system.

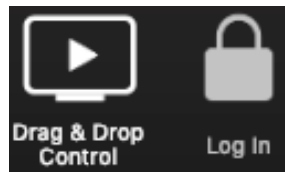

1. **Drag & Drop Control** - used for 'Drag & Drop' control of source selection for each Multicast Receiver including image preview of source devices throughout
2. **Video Wall Control** - used for 'Drag & Drop' control of source selection for each video wall array within the system, including image preview of source devices throughout
3. **Log In** - used to log into the system as a User or Administrator

The **Administrator** menu is accessed from a single password (see page 08 to log in). This menu allows to the Multicast system to be completely configured with access to all settings and features of the system.

Please note: it is not recommended to leave Administrator access or the Administrator password with an end user.

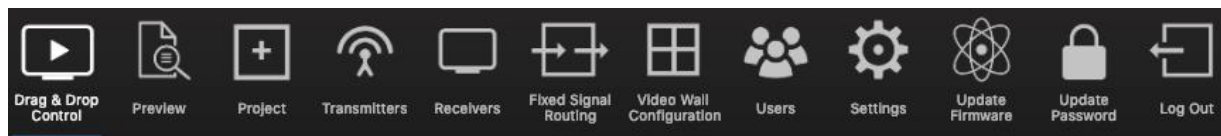

1. **Drag & Drop Control** - used for 'Drag & Drop' control of source selection for each Multicast Receiver including image preview of source devices
2. **Video Wall Control** - used for 'Drag & Drop' control of source selection for each video wall array within the system, including image preview of source devices
3. **Preview** - used to show the active video stream from any connected Multicast Transmitter or Receiver
4. **Project** - used to configure a new or existing Blustream Multicast system
5. **Transmitters** - shows a summary of all Multicast Transmitters installed, with options for EDID management, checking FW version, updating settings, adding new TX's, replacing or rebooting products
6. **Receivers** - shows a summary of all Multicast Receivers installed, with options for resolution output (HDR / scaling), function (video wall mode / matrix), updating settings, adding new RX's, replacing or rebooting products
7. **Fixed Signal Routing** - used for signal routing allowing independent routing of IR, RS-232, USB / KVM, Audio and Video signals
8. **Video Wall Configuration** - used for the set-up and configuration of Multicast receivers to create a video wall array of up to a size of 9x9, including: bezel / gap compensation, stretch / fit, and rotation
9. **Users** - used to set-up or manage users of the system
10. **Settings** - access to various system settings including: network and resetting devices
11. **Update Devices** - used for applying the latest firmware updates to the ACM200 and connected Blustream Multicast Transmitters and Receivers
12. **Update Password** - used to update the Administrator password for access to the ACM200 web-GUI
13. **Log Out** - log out the current User / Administrator

Web-GUI - Drag & Drop Control

The ACM200 Drag & Drop Control page is used to quickly and intuitively change a source input (Transmitter) for each display (Receiver). This page has been designed to allow the User to quickly switch the I/O configuration of the system. Once the system has been fully configured the Drag & Drop Control page will show all online Multicast Transmitter and Receiver products. All Multicast products will display the active stream from the device which refreshes every few seconds.

Due to the size of the display window on certain phones, tablets or laptops, should the number of Transmitters and Receivers be larger than the size available on screen, the User is given the ability to scroll or swipe through available devices (left to right).

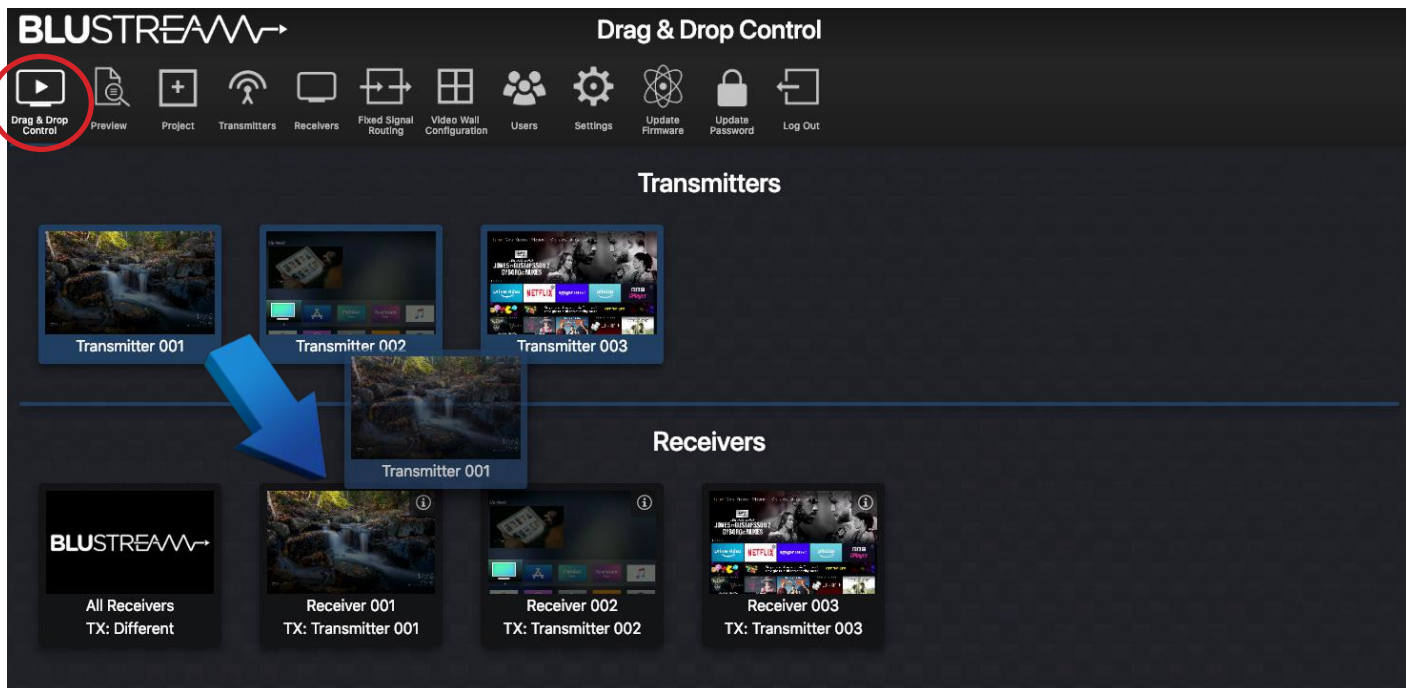

To switch sources, click on the required source and 'Drag & Drop' the Transmitter preview onto the required Receiver product. The Receiver preview window will update with the new live stream of the source selected.

The Drag & Drop switch will amend the Video/Audio stream from Transmitter to Receiver, but not Fixed Routing of control signals.

Should 'No Signal' be displayed in the Transmitter preview window, please check the HDMI source device is powered on, outputting a signal and is connected via HDMI cable to the Multicast Transmitter unit. Check also the EDID settings of the Transmitter device (Multicast will not accept 4K60 4:4:4 signals). Should 'No Signal' be displayed inside the Receiver preview window, check the unit is connected and powered from the network (switch) and has a valid connection to a working Transmitter unit.

There is an 'All Receivers' window located on the left of the Receivers window. Dragging and dropping a Transmitter onto this window will change the routing for ALL Receivers within the system to watch the source selected. Should the preview of this window show the Blustream logo, this signifies that there is a mixture of sources being watched across the range of Receivers within the system. The note underneath 'All Receivers' will display: 'TX: Different'.

Please note: the Drag & Drop Control page is also the home page for Guest Users of the Multicast system - only sources that the Guest or User have permission to view will be visible. For User set-up and permissions, see page 33.

Receivers in Video Wall Mode are not displayed on the Drag & Drop page.

Web-GUI - Video Wall Control

To assist with simplified Video Wall switching control, there is a separate Video Wall Drag & Drop Control page. This menu option is only available once a Video Wall has been configured into the ACM200 / Multicast system.

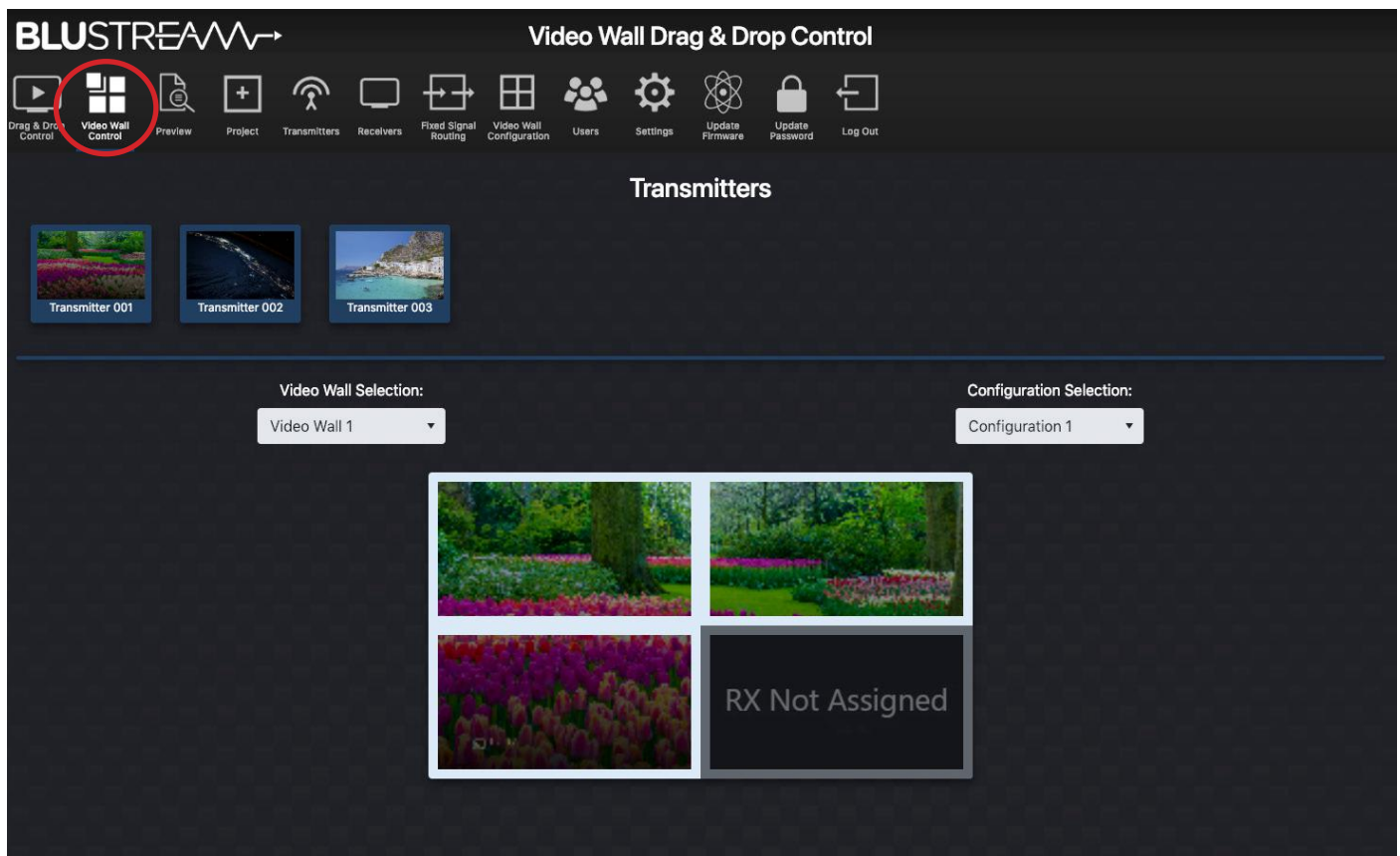

The source (Transmitter) preview windows are shown at the top of the page with the graphical representation of the Video Wall displayed below. To switch the Video Wall array from one source to another Drag & Drop the source preview window onto the Video Wall preview underneath. This will switch all connected screens within the Video Wall (within a group within a Video Wall only) to the same source / Transmitter in the Configuration that is currently selected (in a group). Or Drag & Drop a Transmitter preview onto a 'Single' screen when the Video Wall array is in an individual screen configuration.

Blustream Multicast systems can have multiple Video Walls. Selecting a different Video Wall array, or to deploy a pre-defined Configuration / preset for each Video Wall can be carried out by using the drop down boxes above the graphical representation of the Video Wall. This graphical representation will automatically update as you select a different Video Wall or Configuration.

Should a screen within a Video Wall display on the GUI show 'RX Not Assigned', this means that the Video Wall does not have a Receiver unit assigned to the array. Please revert back to Video Wall set up to assign the Receiver accordingly.

For the advanced API commands for control of Video Wall arrays within a Blustream Multicast system, please refer to the API Commands section at the rear of this manual.

Web-GUI - Preview

The Preview feature is a quick way to view the media being streamed through the Multicast system once configured. Used to preview the stream from any HDMI source device into the Multicast Transmitter, or the stream being received by any Receiver in the system concurrently. This is particularly helpful for debugging and checking source devices are powered on and outputting a HDMI signal, or to check the I/O status of the system:

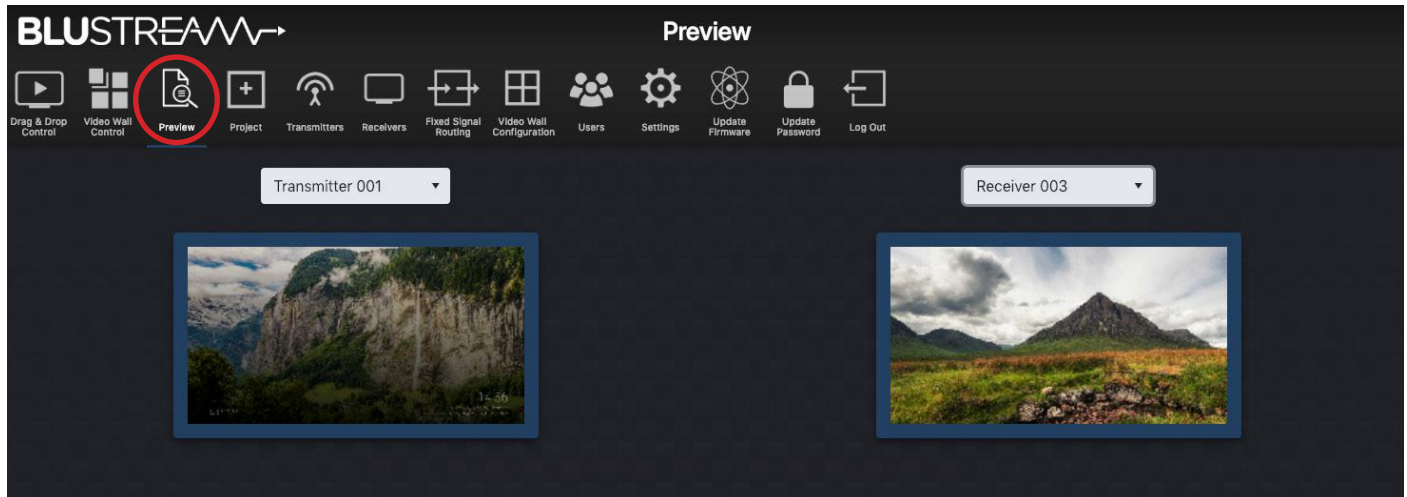

The Preview windows show a live grab of the media which automatically updates every few seconds. To select the Transmitter or Receiver to preview, use the drop down box to select the individual Transmitter or Receiver to preview.

Web-GUI - Project Summary

Outlines the units that are currently set-up in the Multicast system as an overview, or for scanning the network for new devices to assign to the project:

BLUSTREAM Project

Drag & Drop Control | Video Wall Control | Preview | **Project** | Transmitters | Receivers | Fixed Signal Routing | Video Wall Configuration | Users | Settings | Update Firmware | Update Password | Log Out

Current Devices Toggle OSD Export Project Import Project Clear Project

Transmitters				Receivers			
ID	Name	IP Address	Status	ID	Name	IP Address	Status
1	Transmitter 001	169.254.3.1	Online	1	Receiver 001	169.254.6.1	Online
2	Transmitter 002	169.254.3.2	Online	2	Receiver 002	169.254.6.2	Online
3	Transmitter 003	169.254.3.3	Online	3	Receiver 003	169.254.6.3	Online

Unassigned Devices Assign New Devices Continuously Scan & Auto Assign Scan Once

Unassigned Transmitters		Unassigned Receivers	
IP Address	MAC Address	IP Address	MAC Address
There are no unassigned transmitters.		There are no unassigned receivers.	

Options on this page:

- Toggle OSD:** turn On / Off the OSD (On Screen Display). Toggling the OSD On shows the ID number (i.e. ID 001) of the Multicast Receiver on each display as an overlay to the media being distributed. Toggling OSD Off removes the OSD.

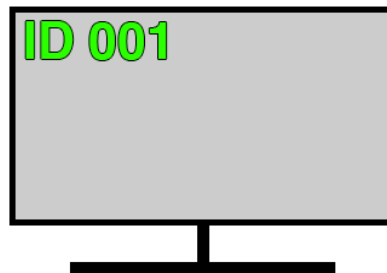

- Export Project:** create a save file (.json) for the configuration of the system.
- Import Project:** import an already configured project into the current system. This is particularly helpful when setting up a secondary system or expansion to a current system off-site where the two systems can be merged into one.
- Clear Project:** clears the current project.
- Continuously Scan & Auto Assign:** continuously scan the network and auto assign new Multicast devices to the next available ID and IP address as connected. If only connecting ONE new unit, use the 'Scan Once' option - the ACM200 will continue to scan the network for new Multicast devices until found, or select this button again to stop the scan.
- Scan Once:** scan the network once for any new Multicast devices connected, and then be presented with a pop up to either manually assign the new device, or auto assign a new unit to the next available ID and IP address as connected.

Web-GUI - Transmitters

The Transmitter summary page is an overview of all Transmitter devices that have been configured within the system, with the ability to update the system as required.

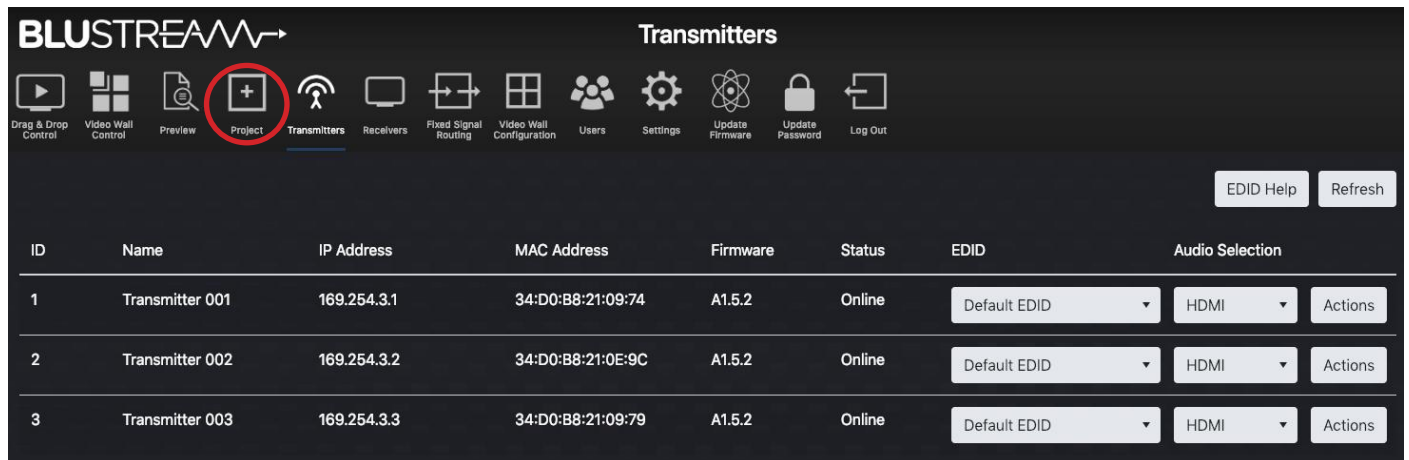

Features of the Transmitter summary page include:

- ID / Input** - the ID / Input number is used for control of the Multicast system when using third party drivers.
- Name** - the name of the Transmitter (typically the device attached to the Transmitter).
- IP Address** - the IP address assigned to the Transmitter during configuration.
- MAC Address** - shows the unique MAC address of the Transmitter.
- Firmware** - displays the firmware version currently loaded onto the Transmitter. For more information on firmware updating, please see 'Update Devices' on page 37.
- Status** - shows the online / offline status of each Transmitter. Should a product show as 'Offline', check the units connectivity to the network switch.
- EDID** - fix the EDID value for each Transmitter (source). This is used to request specific video and audio resolutions for the source device to output. Basic help can be obtained on EDID selection by clicking the button at the top of the page marked 'EDID Help'. EDID selections as follows:
 - Default EDID - the default EDID is for the Transmitter to request a 1080p / 2ch signal from the source device
 - 1080i @ 60Hz 2ch
 - 1080i @ 60Hz 5.1ch
 - 1080i @ 60Hz 7.1ch
 - 1080p @ 60Hz 2ch
 - 1080p @ 60Hz 5.1ch
 - 1080p @ 60Hz 7.1ch
 - 1080p @ 60Hz / 3D 2ch
 - 1080p @ 60Hz / 3D 5.1ch
 - 1080p @ 60Hz / 3D 7.1ch
 - 4K2K 4:2:0 2ch
 - 4K2K 4:2:0 5.1ch
 - 4K2K 4:2:0 7.1ch
 - 4K2K 4:4:4 2ch
 - 4K2K 4:4:4 5.1ch
 - 4K2K 4:4:4 7.1ch
 - DVI 1280 x 1024 @ 60Hz (no audio)
 - DVI 1920 x 1080 @ 60Hz (no audio)
 - DVI 1920 x 1200 @ 60Hz (no audio)
- Audio Selection** - selects either original HDMI audio, or replaces the embedded audio with a local analogue audio input on the Transmitter. Default setting will be 'Auto'.
- Actions** - opens a pop-up window with advanced configuration settings. See following page for further information.
- Refresh** - refresh all current information on the devices within the system.

Web-GUI - Transmitters - Actions

The 'Actions' button allows for advanced features of the units to be accessed and configured.

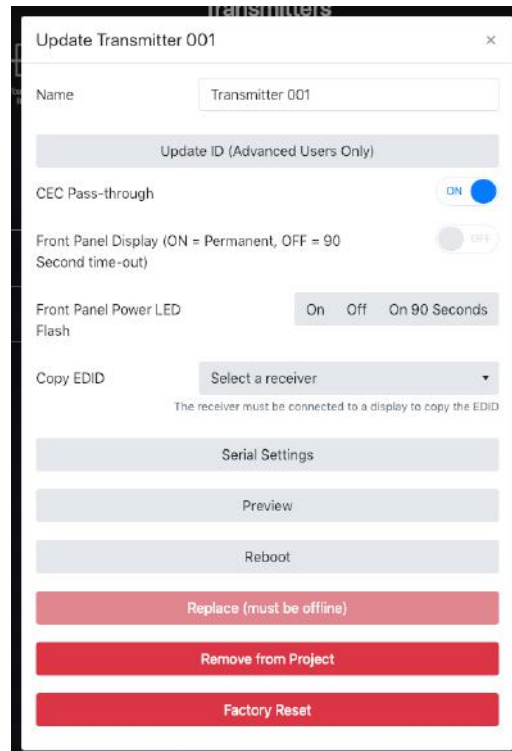

Features of the Actions menu include:

- 1. Name** - Transmitter names can be amended by entering a name into the free-form text box. **Please note:** this is limited to 16 characters in length, and some special characters may not be supported.
- 2. Update ID** - the ID of a unit is set as default to the same number as the last 3 digits of the units IP address i.e. Transmitter number 3 is assigned an IP address of 169.254.3.3 and will have an ID of 3. Amending the ID of the unit is not normally recommended.
- 3. CEC Pass-through (On / Off)** - allows for CEC (Consumer Electronic Command) to be sent through the Multicast system to and from the source device connected to the Transmitter. **Please note:** CEC must be enabled on the Receiver unit also for the CEC commands to be sent between. Default setting for this feature is Off.
- 4. Front Panel Display (On / Off)** - use this to enable / disable the dual 7-segment LED displays on the front of the Transmitter. The front panel display of the Multicast unit will automatically time-out after 90 seconds and turn off.
- 5. Front Panel Power LED Flash (On / Off / On 90 Seconds)** - will flash the power LED on the front panel of the Transmitter to help identify the product following auto configuration. Options are: flash the power light continuously, or flash the LED for 90 seconds before the LED goes back to being permanently lit. **Please note:** the front panel LED's will automatically time-out after 90 seconds with the front panel display. Press one of the CH buttons to wake the unit.
- 6. Copy EDID** - see page 21 for further information on Copy EDID.
- 7. Serial Settings** - turn on serial 'Guest Mode' and set the individual serial port settings for the device (i.e. Baud Rate, Parity etc).
- 8. Preview** - displays a pop-up window with live a screen grab of the source device connected to the Transmitter.
- 9. Reboot** - reboots the Transmitter.
- 10. Replace** - used to replace an offline Transmitter. **Please note:** the Transmitter to be replaced must be offline for this feature to be utilised, and the new Transmitter must be a factory default unit with default IP address: 169.254.100.254.
- 11. Remove from Project** - removes the Transmitter device from the current project.
- 12. Factory Reset** - restores the Transmitter to its original default settings and sets the IP address to: 169.254.100.254.

Web-GUI - Transmitters - Actions - Copy EDID

EDID (Extended Display Identification Data) is a data structure that is used between a display and a source. This data is used by the source to find out what audio and video resolutions are supported by the display then from this information the source will discover what the best audio and video resolutions need to be output.

While the objective of EDID is to make connecting a digital display to a source a simple plug-and-play procedure, issues can arise when multiple displays, or video matrix switching is introduced because of the increased number of variables.

By pre-determining the video resolution and audio format of the source and display device you can reduce the time need for EDID hand shaking thus making switching quicker and more reliable.

The Copy EDID function allows the EDID of a display to be grabbed and stored within the ACM200. The EDID configuraiton of the screen can be recalled within the EDID selection of the Transmitter. The displays EDID can then be applied to any source device not displaying correctly on the screen in question.

It is recommended to ensure that the media from the Transmitter with the custom EDID displays correctly on other displays within the system.

Please note: it is important that only one screen is viewing the Transmitter at the time the EDID Copy takes place.

Web-GUI - Receivers

The Receiver summary window gives an overview of all the Receiver devices that have been configured within the system, with the ability to update the system as required.

ID	Name	IP Address	MAC Address	Firmware	Status	Source	Scaler Resolution	HDR	Function
1	Receiver 001	169.254.6.1	34:D0:B8:21:09:87	A1.5.2	Online	Transmitter 001	Pass Through	On	Matrix
2	Receiver 002	169.254.6.2	34:D0:B8:21:12:7E	A1.5.2	Online	Transmitter 002	Pass Through	On	Matrix
3	Receiver 003	169.254.6.3	34:D0:B8:21:09:90	A1.5.2	Online	Transmitter 003	Pass Through	On	Matrix

Features of the Receiver summary page include:

- ID / Output** - the ID / output number is used for control of the Multicast system when using third party drivers.
- Name** - the name of the Receivers (typically the device attached to the Receiver) are automatically assigned default names i.e. Receiver 001 etc. Receiver names can be amended within the Device Setup page (within the Wizard), or by clicking on the 'Actions' button for an individual unit - see page 23.
- IP Address** - the IP address assigned to the Receiver during configuration.
- MAC Address** - shows the unique MAC address of the Receiver.
- Firmware** - displays the firmware version currently loaded onto the Receiver. For more information on updating firmware, please see 'Update Devices
- Status** - shows the online / offline status of each Receiver. Should a product show as being 'Offline', check the units connectivity to the network switch.
- Source** - shows the current source selected at each Receiver. To switch source selection, choose a new Transmitter from the drop-down selection.

Resolution - adjust the output resolution using the built-in video scaler inside the Multicast Receiver. The scaler is capable of both upscaling and downscaling the incoming video signal. Output resolutions include:

- Pass Through - the Receiver will output the same resolution that the source is outputting up to 4K 30Hz output

- 2160p @ 30Hz
- 2160p @ 24Hz
- 1080p @ 60Hz
- 1080p @ 50Hz
- 720p @ 60Hz
- 720p @ 50Hz
- 1280x1024 @ 60Hz
- 1024x768 @ 60Hz
- 1360x768 @ 60Hz
- 1440x900 @ 60Hz
- 1680x1050 @ 60Hz

- HDR On/Off** - turns on HDR (High Dynamic Range) compatibility - only use with screens that support HDR.
- Function** - identifies the Receiver as a standalone product (Matrix) or as part of a Video Wall.
- Actions** - see next for breakdown of additional actions options
- Scaling Help** - you can obtain some basic help with scaling selection by clicking the button at the top of the page marked 'Scaling Help'.
- Refresh** - click here to refresh all current information on the devices within the system.

Web-GUI - Receivers - Actions

The 'Actions' button allows for advanced features of the Receiver to be accessed and configured.

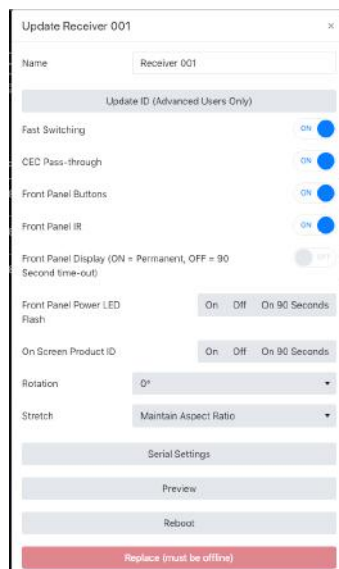

1. **Name** - can be amended by entering a name into the free-form text box. **Please note:** this is limited to 16 characters in length, and some special characters may not be supported.
2. **Update ID** - the ID is defaulted to the last 3 digits of the device IP address i.e. Receiver 3 is assigned an IP address of 169.254.6.3. Update ID allows you to amend the ID of the unit (*not recommended*).
3. **Fast Switching** - switches the video first, with the audio, IR, RS-232, USB / KVM all switched after. **Please note:** whilst the video feed may switch faster, other parts of the feed (i.e. audio, IR etc) will take slightly longer to catch up.
4. **CEC Pass-through (On / Off)** - allows for CEC (Consumer Electronic Command) to be sent through the Multicast system to and from the display device connected to the Receiver. Please note: CEC must also be enabled on the Transmitter.
5. **Front Panel Buttons (On / Off)** - the Channel buttons on the front of each Receiver can be disabled to stop unwanted switching or manual configuration once the Receiver have been configured.
6. **Front Panel IR (On / Off)** - enables or disables the Receiver from accepting IR commands to change source.
7. **On Screen Product ID (On / Off / 90 Seconds)** - turn On / Off the On Screen Product ID. Toggling the On Screen Product ID On shows the ID (i.e. ID 001) of the Receiver overlayed on the display connected to the device. If 90 Seconds is selected, the OSD displays for 90 seconds. Toggling On Screen Product ID Off removes the OSD.
8. **Front Panel Power LED Flash (On / Off / On 90 Seconds)** - will flash the power LED on the front panel of the Receiver to help identify the device. Options are to flash the power light continuously, or flash the LED for 90 seconds. Please note: the front panel LED's will time-out after 90 seconds.
9. **Front Panel Display (On / 90 Seconds)** - use this to enable / disable the dual 7-segment LED displays on the front of the Receiver. The front panel display of the device will automatically time-out after 90 seconds until woken.
10. **Rotation** - rotate the image by: 0, 90, 180 and 270 degrees.
11. **Stretch** - re-sizes the image to 'Stretch' to the aspect of the display, or 'Maintain Aspect Ratio' of the source device output.
12. **Serial Settings** - enable serial 'Guest Mode' and set the serial port settings for the device (i.e. Baud Rate, Parity etc).
13. **Preview** - displays a pop-up window with live screen grab of the source device connected to the Transmitter.
14. **Reboot** - reboots the Receiver.
15. **Replace** - used to replace an offline Receiver. Please note: the unit to be replaced must be offline for this feature to be utilised, and the new Receiver must be a factory default unit with IP address: 169.254.100.254.
16. **Remove from Project** - removes the Receiver from the project. This does not apply factory reset the Receiver.
17. **Factory Reset** - restores the Receiver to it's original default settings and sets the default IP address.

Web-GUI - Fixed Signal Routing

The ACM200 is capable of advanced independent routing of the following signals via the Multicast system:

- Video
- Audio
- Infrared (IR)
- RS-232
- USB / KVM
- CEC (Consumer Electronic Command)

This allows each signal to be fixed from one Multicast product to another and not be affected by standard video switching. This can be useful for IR, CEC or RS-232 control of products in the field using the Multicast system to extend control commands from a third party control solution, or a manufacturers IR remote control.

Please note: with the exception of IR and RS-232, routing can only be fixed from a Receiver to a Transmitter product. Although routing can only be set up one way, the communication is bi-directional between the two products. For routing IR or RS-232 between 2x Transmitter units, please see page 19 / 20.

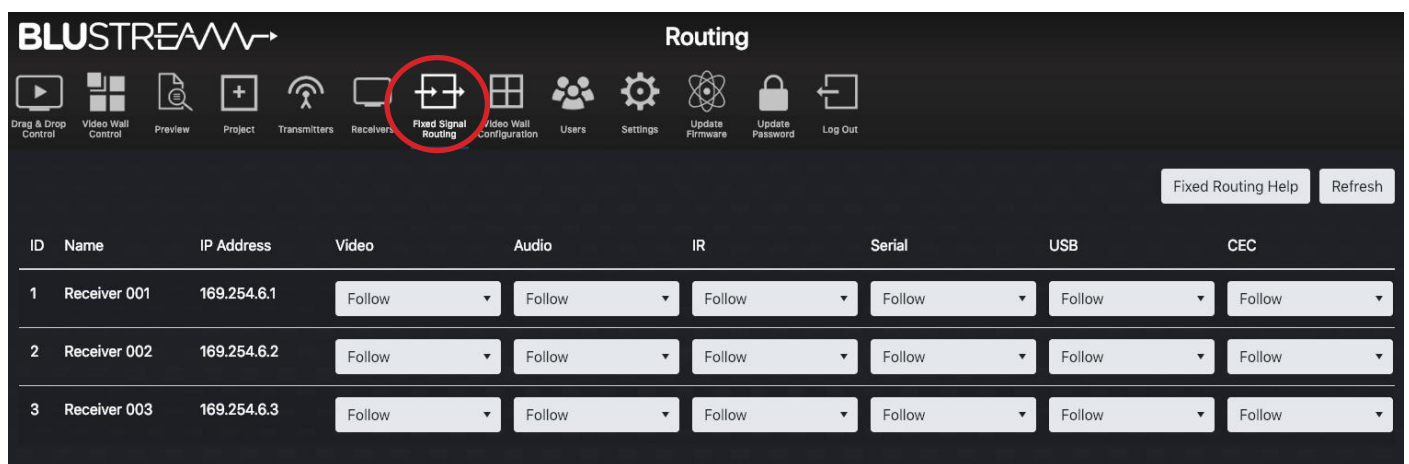

By default, the routing of: Video, Audio, IR, Serial, USB and CEC will automatically follow the Transmitter selection of the Receiver unit.

To select a fixed route, use the drop down box for each of the individual signals / Receivers to fix a route.

Once an ACM200 has been added into a Multicast system, the IR switching control abilities (not IR pass-through) and the front panel CH buttons of the Multicast Receivers are enabled by default. This is disabled from the Actions function contained within the Receiver summary page - see page 23.

Routing can be cleared by selecting 'Follow' at any point from the web-GUI. More information on Fixed Routing can be found by clicking 'Fixed Routing Help'.

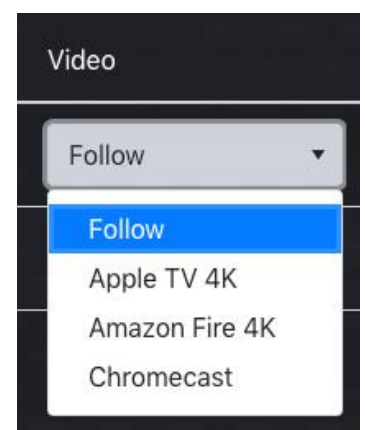

For advanced routing commands for Video, Audio, IR, RS-232, USB and CEC when using with a 3rd party control system, please refer to the API section at the rear of this manual.

Fixed Routed Audio

The ACM200 allows for the audio component of a HDMI signal to be routed independently throughout the Blustream Multicast system. Under normal operation the embedded audio within a HDMI signal will be distributed with the associated video signal from Transmitter to Receiver/s.

The fixed audio routing capabilities of the ACM200 allow for the audio track from one source to be embedded onto another Transmitters video stream.

Fixed Routed IR

The fixed IR routing feature allows a fixed bi-directional IR link between 2x Multicast products. The IR signal is only routed between configured RX to TX, or TX to TX products. This can be useful for sending IR from a centrally located third party control solution (ELAN, Control4, RTi, Savant etc) and using the Blustream Multicast system as a method of extending IR out to a display or another product in the system. The IR link is bi-directional so can also be sent back the opposite way at the same time.

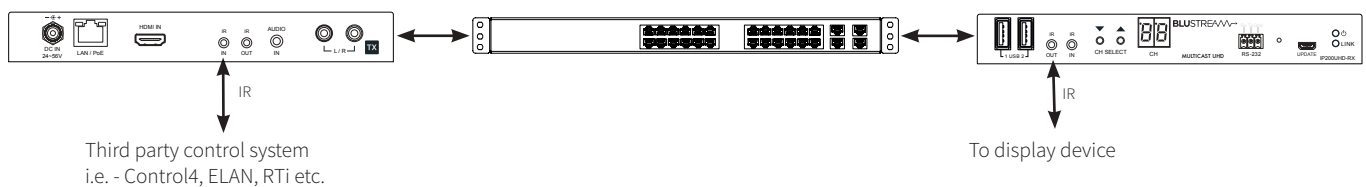

Connections:

The third party control processor IR, or Blustream IR receiver, is connected to the IR RX socket on the Multicast Transmitter or Receiver.

Please note: You must use Blustream 5V IRR Receiver or Blustream IRCAB (3.5mm stereo to mono 12V to 5V IR converter cable). Blustream Infrared products are all 5V and **NOT** compatible with alternative manufacturers Infrared solutions.

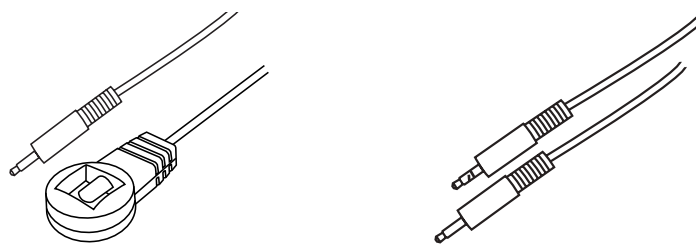

The Blustream 5V IRE1 Emitter is connected to the IR OUT socket on the Multicast Transmitter or Receiver.

The Blustream IRE1 & IRE2 Emitters are designed for discrete IR control of hardware.

(IRE2 - Dual Eye Emitter sold separately)

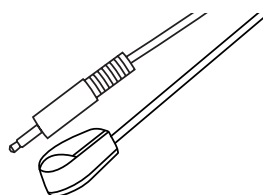

Fixed Routed USB / KVM

The fixed USB routing feature allows a fixed USB link between a Multicast Receiver/s and a Transmitter. This can be useful for sending KVM signals between a users position to a centrally located PC, server, CCTV DVR / NVR etc.

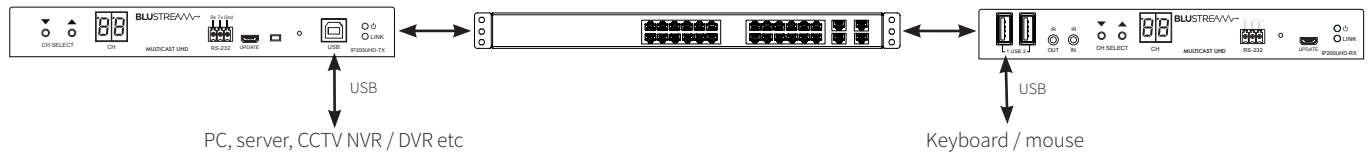

USB Specifications:

USB Specification	USB2.0
Extension	Over IP, Hybrid redirection technology
Distance	100m
Distance Ext.	via Ethernet switch hub
Max Downstream Devices	5
Topology	1 to 1 1 to many exclusively (USB/IP) 1 to many simultaneously but limited number of USB devices (USB/IP)* 1 to many simultaneously Keyboard / Mouse (K/MoIP)
USB R/W Performance *	R: 69.6 Mbps W: 62.4 Mbps

* Benchmark Reference: Read / Write USB to SATA HD without Multicast system R: 161.6 Mbps / W: 161.6 Mbps

Fixed Routed CEC

CEC or Consumer Electronic Command is a HDMI embedded control protocol that allows for commands to be sent from one HDMI device to another for simple actions such as: Power, Volume etc.

The Blustream Multicast system allows for the CEC channel within the HDMI link between two products (source and sink) to communicate with eachother using the CEC protocol.

CEC must be enabled (this is sometimes referred to as 'HDMI Control') on both the source device and the display device in order for the Multicast system to communicate the CEC commands over the Multicast link.

Please note: the Blustream Multicast system will only transport the CEC protocol transparently. It is advisable to ensure that the source and sink devices will communicate effectively before committing to this control type with Multicast. Should an issue be experienced with CEC communication between the source and sink directly, this will be mirrored when sending through the Multicast system.

Web-GUI - Video Wall Configuration

Blustream Multicast Receivers can be configured to be part of a Video Wall array within the ACM200. Any Multicast system can contain up to 9x Video Wall arrays of differing shapes and sizes. Ranging from 1x2 up to 9x9.

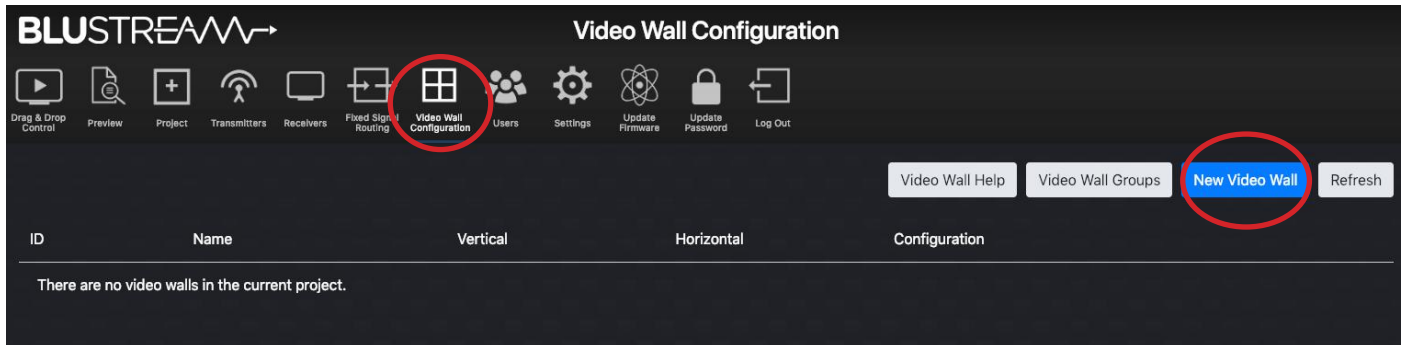

To configure a new Video Wall array, navigate to the Video Wall Configuration menu and click the button labelled 'New Video Wall' as marked at the top of the screen. Help with creating a Video Wall array can be found by clicking the button marked 'Video Wall Help'.

Please note: the Multicast Receivers that will be used for the Video Wall should have been configured as individual Receivers before proceeding past this point. It is good practice to have already named the Multicast Receivers for ease of configuration i.e. "Video Wall 1 - Top Left".

Video Wall ID	1
Name	Video Wall 1
Horizontal	2
Vertical	2
<input type="button" value="Create"/>	

Enter the relevant information into the pop-up window to name and select the number of panels both horizontally and vertically within the Video Wall array. Once the correct information has been inserted onto the screen, select 'Create' to create the Video Wall array template within the ACM200.

Web-GUI - Video Wall Configuration - continued...

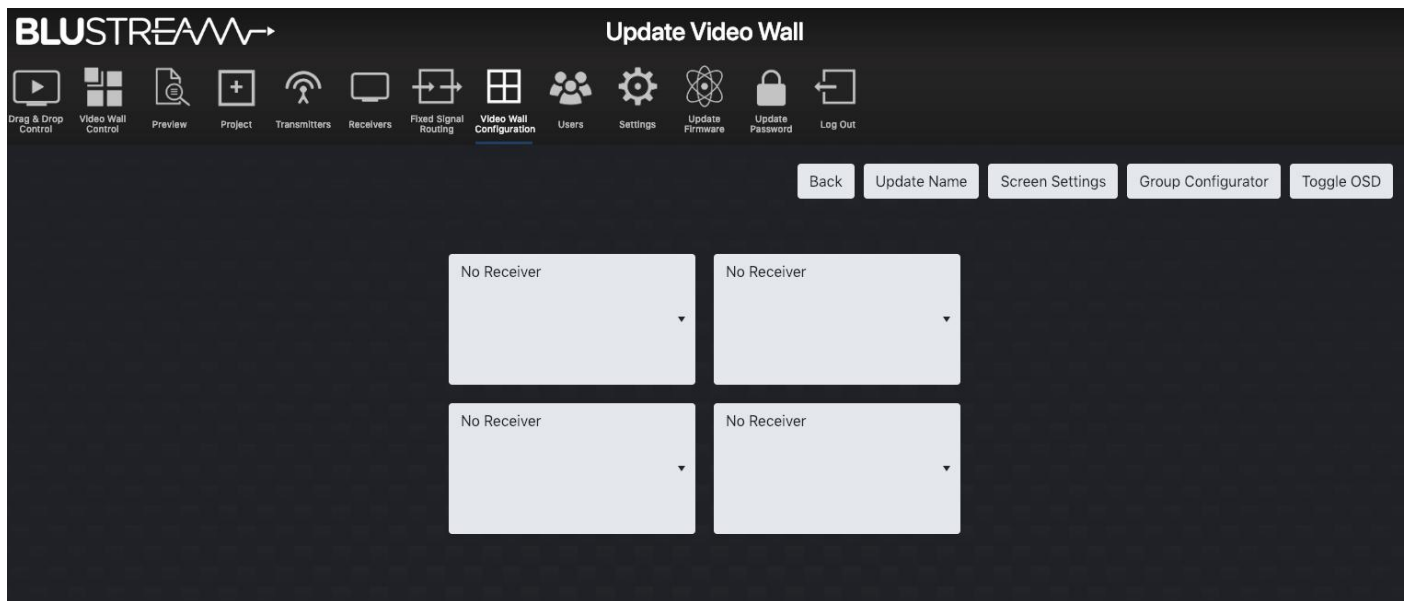

The menu page for the new Video Wall array has the following options:

1. **Back** - returns to the previous page for creating a new Video Wall.
2. **Update Name** - amend the name given to the Video Wall array.
3. **Screen Settings** - adjustment of bezel / gap compensation of the screens being used. See next page for more details on Bezel settings.
4. **Group Configurator** - there are options to be able to create multiple configurations (or 'presets') for each Video Wall array within the Multicast system. The grouping / preset allows for the Video Wall to be deployed in multiple ways i.e. grouping different numbers of screens together to create different sized walls within a single array.
5. **Toggle OSD** - turn On / Off the OSD (On Screen Display). Toggling the OSD On will show the ID number (i.e. ID 001) of the Multicast Receiver on each display connected to the Receiver as an overlay to the media being distributed. Toggling OSD Off removes the OSD. This allows easier identification of displays within a Video Wall during configuration and set-up.

Display / Receiver Assign:

The ACM200 will create a visual representation of the Video Wall onto the page. Use the drop down arrows for each screen to select the relevant Multicast Receiver product connected to each screen on the Video Wall array.

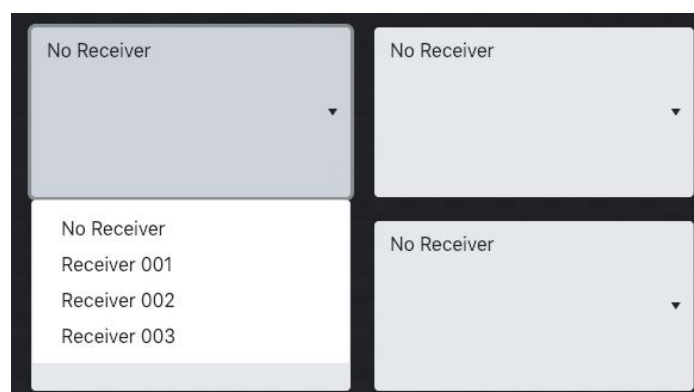

Web-GUI - Video Wall Configuration - Bezel Settings

This page allows for the compensation for the size of each screen bezel within the Video Wall, or alternatively for any gaps inbetween screens. By default, the Multicast system will insert the bezels of the Video Wall screens “inbetween” the overall image (splitting the image). This will mean that the bezels of the screens do not sit “over” any part of the image. By adjusting the Outer Width (OW) vs View Width (VW), and the Outer Height (OH) vs View Height (VH), the screen bezels can be adjusted to sit “on top” of the image that is being displayed.

All units are by default 1,000 - this is an arbitrary number. It is recommended to use the dimensions of the screens being used in mm. To compensate for bezel size of the screens being used, reduce the View Width and View Height accordingly to compensate for the size of the bezels. Once the outcome of the corrections required has been obtained, the 'Copy Bezels to All' button can be used to copy the settings to each display. Click 'Update' to confirm settings and return to the previous Update Video Wall screen.

The 'Bezel Help' button opens a pop-up window with guidance to the correction and adjustment of these settings.

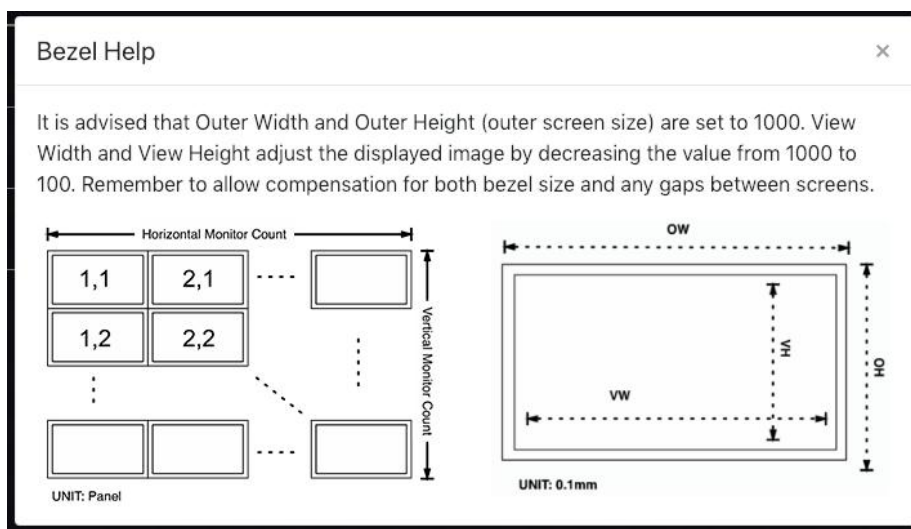

Web-GUI - Video Wall Configuration - Group Configurator

Once the Video Wall array has been created, it can be configured for different display options. The Video Wall Configurator allows for presets to be created for deploying the Video Wall to adjust for different groups of images across the array. Click the 'Group Configurator' button from the Update Video Wall screen.

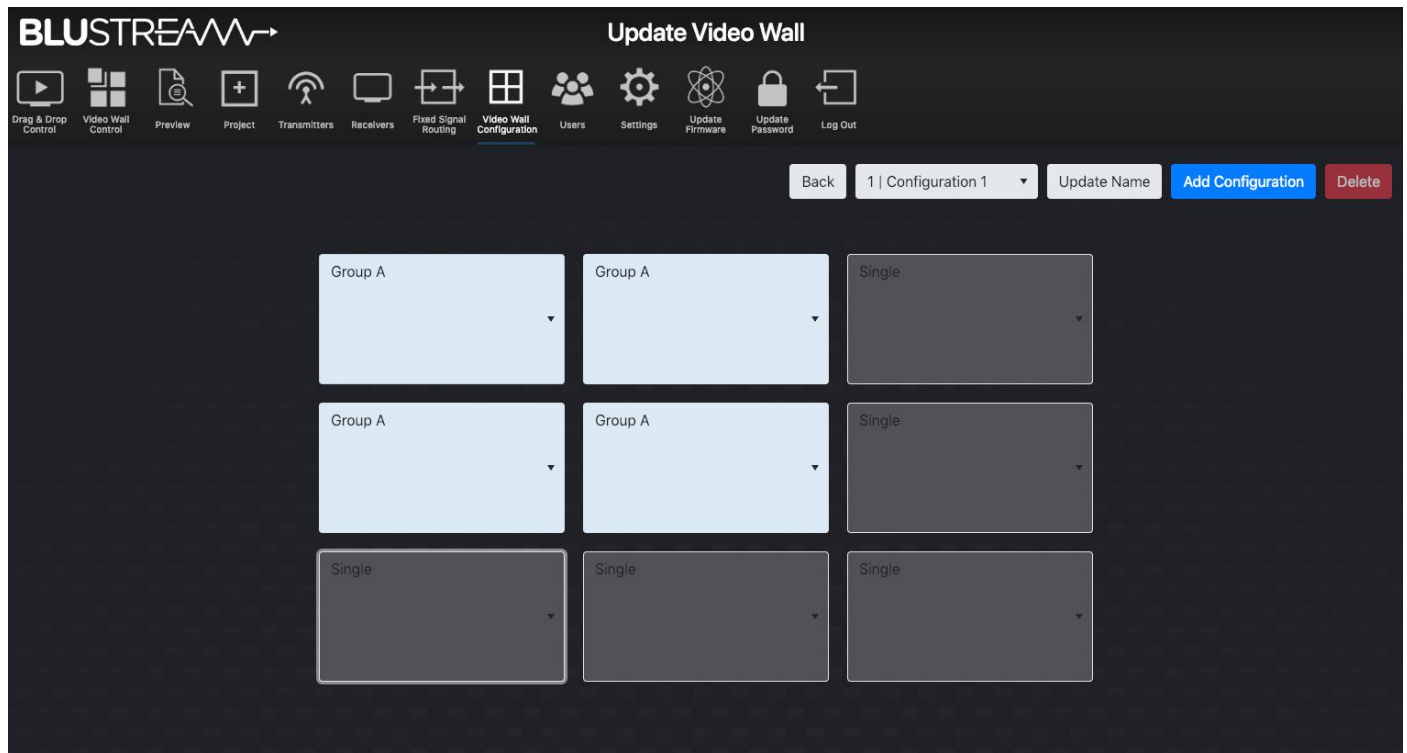

Options within this menu as follows:

1. **Back** - navigates back to the Update Video Wall page without making any changes to the set-up.
2. **Configuration Dropdown** - move between different configurations / presets previously set-up for the Video Wall array. By default, 'Configuration 1' will be inserted for a Video Wall being created and configured for the first time.
3. **Update Name** - set the name of the configuration / preset i.e. 'Single Screens' or 'Video Wall'. By default, configuration / preset names will be set as 'Configuration 1, 2, 3...' until changed.
4. **Add Configuration** - adds a new configuration / preset for the selected Video Wall.
5. **Delete** - removes the currently selected configuration.

Group Assign:

Grouping allows for the Video Wall to be deployed in multiple ways i.e. creating different sized Video Walls within a larger Video Wall array. Use the dropdown selection for each screen to create a Group within the Video Wall:

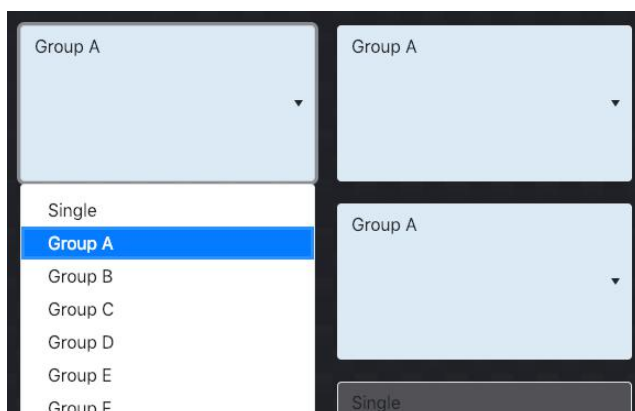

See next page for further explanation on how a larger Video Wall array can have multiple Groups configured within.

Web-GUI - Video Wall Configuration - Group Configurator

For example: a 3x3 Video Wall array can have multiple configurations / presets:

- For displaying 9x different source media streams - so that all screens work independently with each individual screen showing a single source - not grouped (leave all dropdowns as 'Single').
- As a 3x3 Video Wall - displaying one source media stream across all 9 screens (all screens need to be selected as 'Group A').
- For displaying a 2x2 Video Wall image within the overall 3x3 Video Wall array. This can have 4x different options:
 - With the 2x2 in the top left of the 3x3, with 5x individual screens to the right and bottom (select the 2x2 in the top left as Group A with other screens set as 'Single') - see example below...
 - With the 2x2 in the top right of the 3x3, with 5x individual screens to the left and bottom (select the 2x2 in the top right as Group A with other screens set as 'Single').
 - With the 2x2 in the bottom left of the 3x3, with 5x individual screens to the right and top (select the 2x2 in the bottom left as Group A with other screens set as 'Single').
 - With the 2x2 in the bottom right of the 3x3, with 5x individual screens to the left and top (select the 2x2 in the bottom right as Group A with other screens set as 'Single').

With the above example, there would be the need to create 6 different configurations for the Video Wall array, allocating the grouped screens to a Group using the selection dropdown. The Configurations / Groups can be renamed as required using the 'Update Name' option in the Group Configuration screen.

Additional configurations can be created with screens assigned as groups. This allows multiple video sources to be viewed at the same time and will appear as a Video Wall within a Video Wall. The below example has two different sized Video Walls inside a 3x3 array. This configuration contains 2 groups:



Web-GUI - Video Wall Configuration

Once the Video Wall has been created, named accordingly, and groups / presets have been assigned, the configured Video Wall can be viewed from the main Video Wall Configuration page:

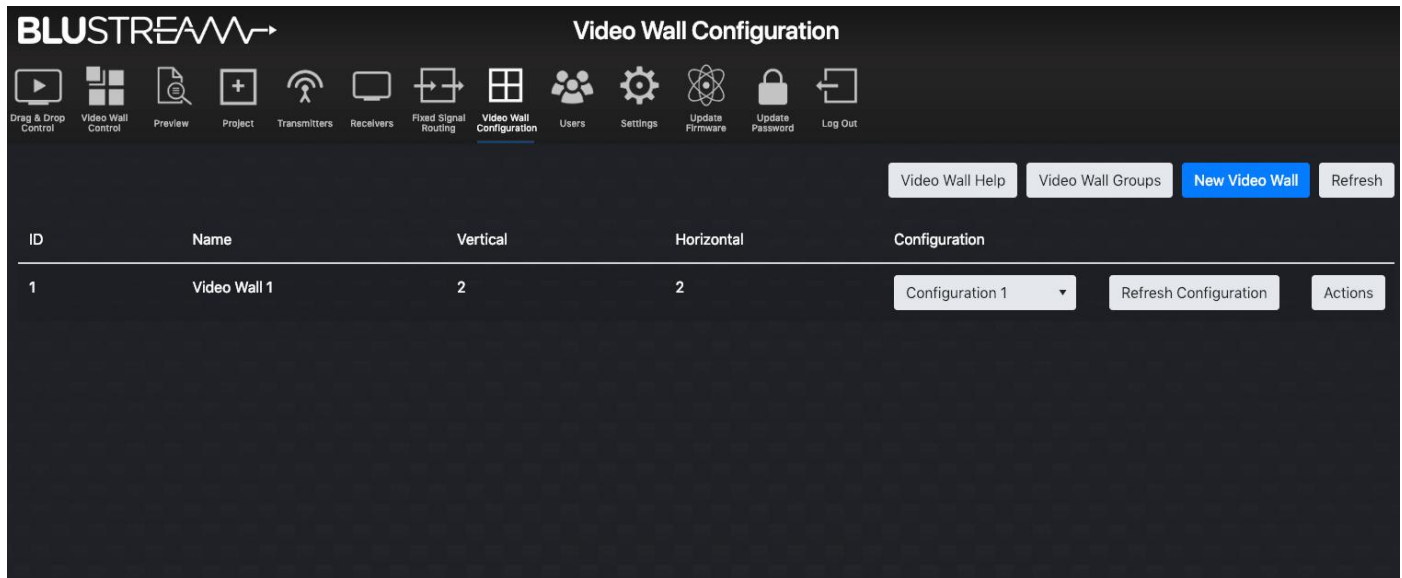

Configurations / presets that have been designed within the system will now appear within the Video Wall Groups page. The Video Wall Configuration page allows for a group to be switched.

The 'Refresh' button refreshes the current page and the configuration of the Video Wall array currently being displayed. This is particularly helpful when testing Video Wall configuration commands from a third party control system.

Please see the advanced API commands for use with third party control systems for Video Wall control, Configuration switching and Group selection towards the rear of this guide.

Web-GUI - Users

The ACM200 has the ability for individual Users to log into the web-GUI of the Multicast system and access individual parts / zones of the system, for full control of the entire Multicast system, or for simple control of which source is being watched in selected locations only. For assistance setting up new Users, click on the button marked 'Users Help'.

To set-up a new User, click 'New User' at the top of the screen:

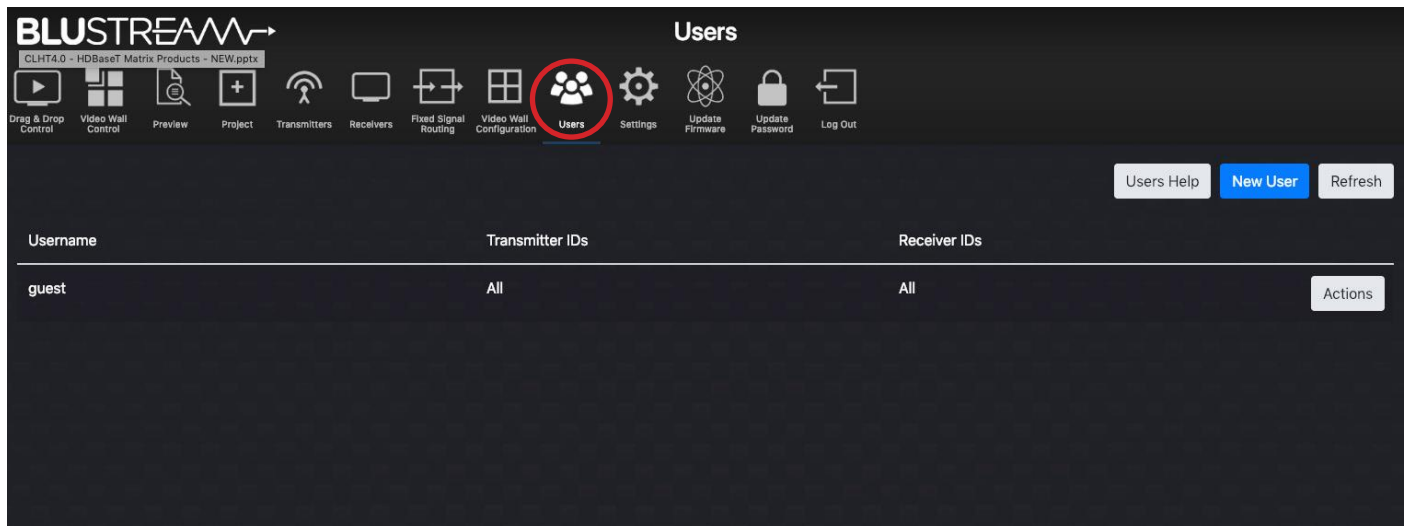

Enter the new User credentials into the window that appears and click 'Create' once completed:

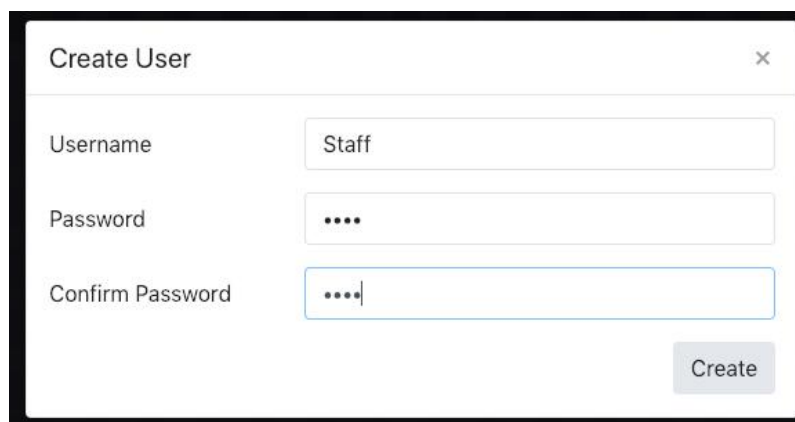

The new User will then appear in the Users menu page ready for access / permissions to be configured:

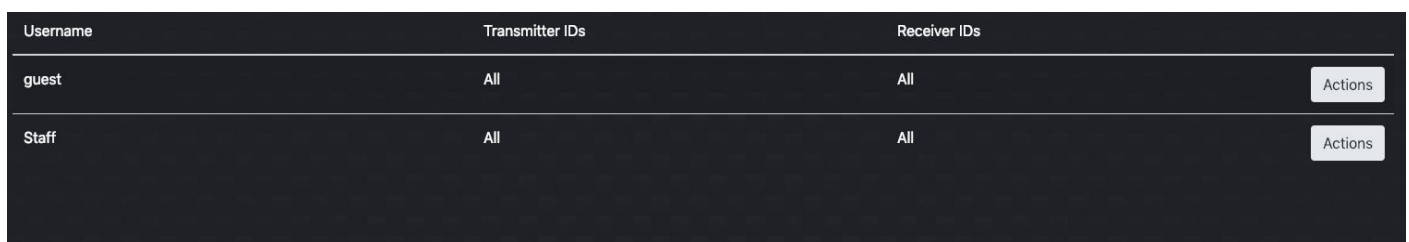

Web-GUI - Users - continued...

To select individual User permissions, update the User password, or to remove the User from the Multicast system, click the 'Actions' button.

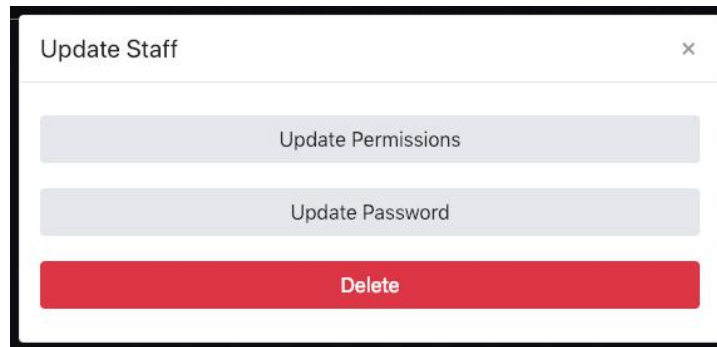

The Permissions option gives access to select which Transmitters or Receivers the User can see within their control pages (Drag & Drop Control, and Video Wall Control). With all boxes checked next to each Transmitter or Receiver, the User can preview and switch across the entire system. If the User is only to be able to control one screen / receiver, then uncheck all other Receivers. Likewise, if the User is not to be given access to one (or more) source devices, these Transmitters should be unchecked.

Where there is a Video Wall array in the Multicast system, a User will need access to **ALL** associated Receivers to be able to gain switching control of the Video Wall. If the User does not have access to all Receivers, the Video Wall will not appear in the Video Wall Control page.

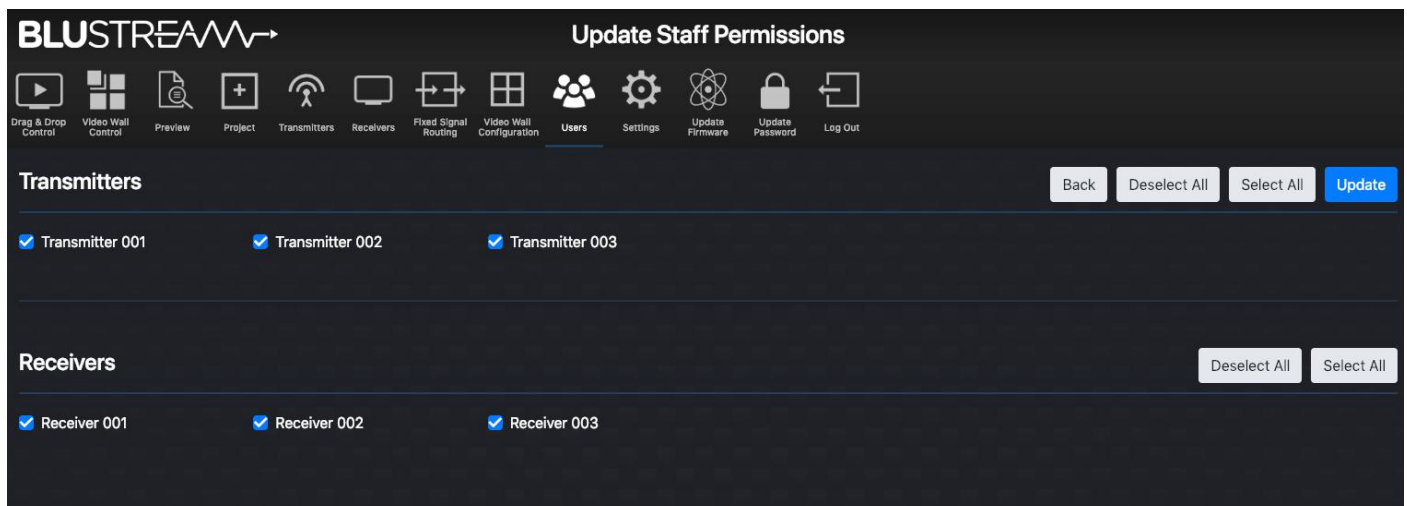

Once the User permissions have been selected, click 'Update' to apply the settings.

Please note: in order to stop non-secure access to the web interface (i.e. with no password), the 'Guest' account must be deleted after a new user with access to the sources / screens applicable set-up. This way, any User of the system is required to enter a password to gain switching control of the system.

Web-GUI - Settings

The Settings page of the ACM200 will provide an overview of the general settings, and control / video network settings of the unit with the ability to amend and update the unit accordingly.

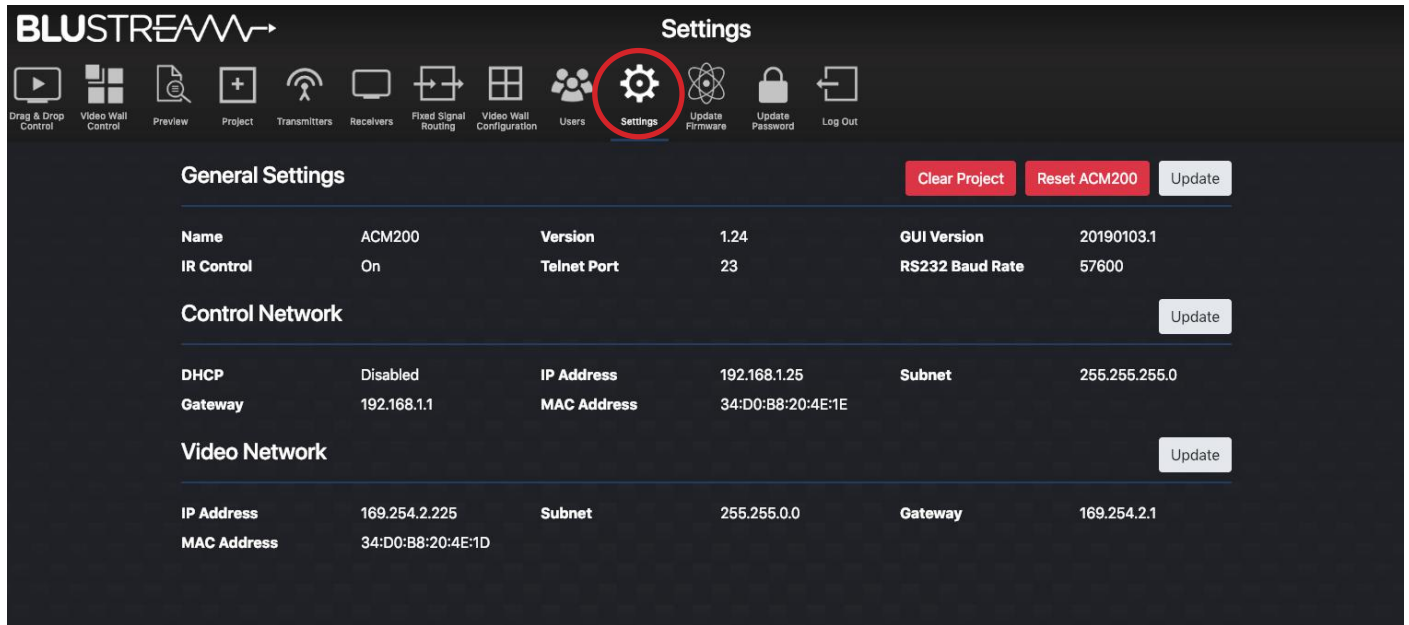

The 'Clear Project' removes all Transmitters, Receivers, Video Walls and Users that have been created from the current project file contained within the ACM200. Confirm by selecting 'Yes'.

Please note: the New Project Setup Wizard will appear after using the 'Clear Project' function. Should a project save file not have been created prior to clearing the project, it is not possible to restore the system after this point.

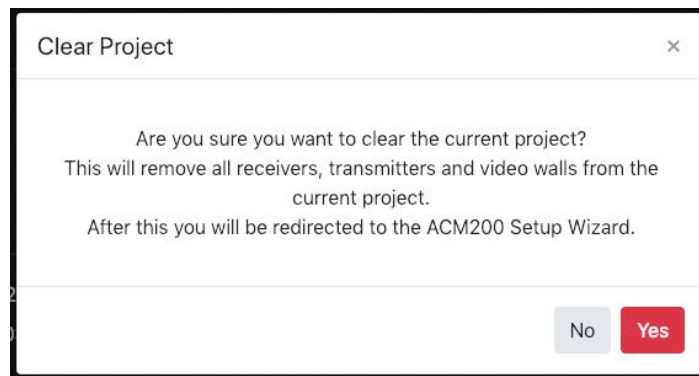

Web-GUI - Settings - continued...

The 'Reset ACM200' option allows for the following:

1. Reset System to factory default (*excludes Network settings*)
2. Reset Network to default settings (*excludes System settings*)
3. Reset ALL System and Network settings back to factory default

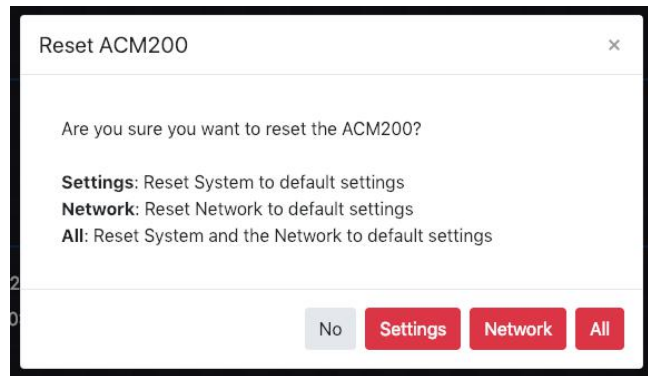

Under general settings, the 'Update' option allows for the following:

1. Turn On / Off IR control to enable / disable the IR input of the ACM200 from accepting IR commands from a third party control solution.
2. Update the Telnet port number that the Control port of the ACM200 communicates through. The default port number used is port 23 which will be used for all official Blustream third party control drivers.
3. Update the RS-232 Baud Rate of the DB9 connection of the ACM200 to suit a third party control processor. The default Baud Rate used is: 57600.

The IP addresses of the two RJ45 ports on the ACM200 can be updated with individual IP, Subnet and Gateway addresses. Use the 'Update' button for either the Control Network or Video Network to update the information for the ports required. The Control Port can be set to DHCP by selecting 'On':

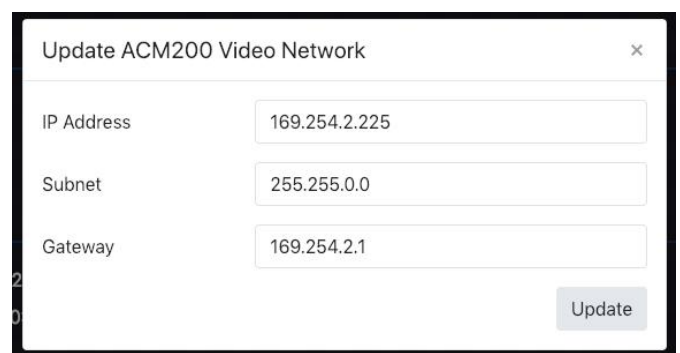
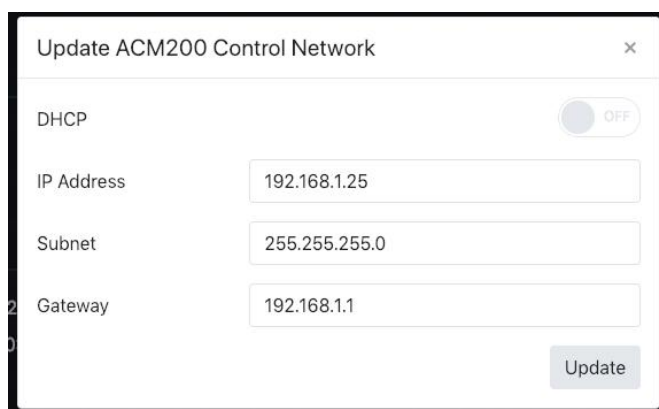

IMPORTANT: Amending the Video Network IP Address out of the 169.254.x.x range will stop communication between the ACM200 and the Multicast Transmitters and Receivers that have been pre-configured. Whilst the ACM200 can be moved out of the recommended range, the IP addresses of ALL Transmitters and Receivers would need to be amended to the same IP range to ensure connectivity and control of the Multicast system. **Not recommended.**

Web-GUI - Update Firmware

The Update Firmware page allows for the firmware updating of:

- The ACM200 unit
- Multicast Transmitter and Receiver units

Please note: firmware packages for the ACM200, Multicast Transmitter and Receiver products are individual. It is recommended that firmware updating is only completed from a desktop or laptop PC that is hard-wired into the network.

Updating the ACM200:

Download the ACM200 Firmware file (.bin) from the Blustream website to your computer.

Transmitters			Receivers		
ID	Name	Firmware	ID	Name	Firmware
1	Transmitter 001	A1.5.2	1	Receiver 001	A1.5.2
2	Transmitter 002	A1.5.2	2	Receiver 002	A1.5.2
3	Transmitter 003	A1.5.2	3	Receiver 003	A1.5.2

Click on the button marked 'Upload ACM200 Firmware'



Select the [ACM200].bin file already downloaded to your computer for the ACM200. The file will automatically upload to the ACM200 which takes approximately 2 minutes to complete. The page refreshes to the Drag & Drop page once complete.

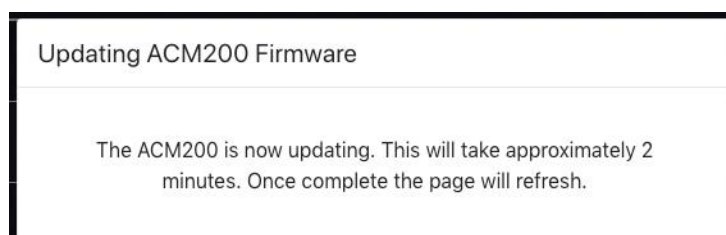

Web-GUI - Update Firmware - continued...

The Update Firmware page is also used for firmware upgrading the firmware of Blustream Transmitters or Receivers. The page allows for multiple Transmitter, or, Receiver units to be upgraded (i.e. all Receivers at once, or, all Transmitters at once - not both simultaneously).

The most current firmware version for the Multicast Transmitters and Receivers can be downloaded from the Blustream website.

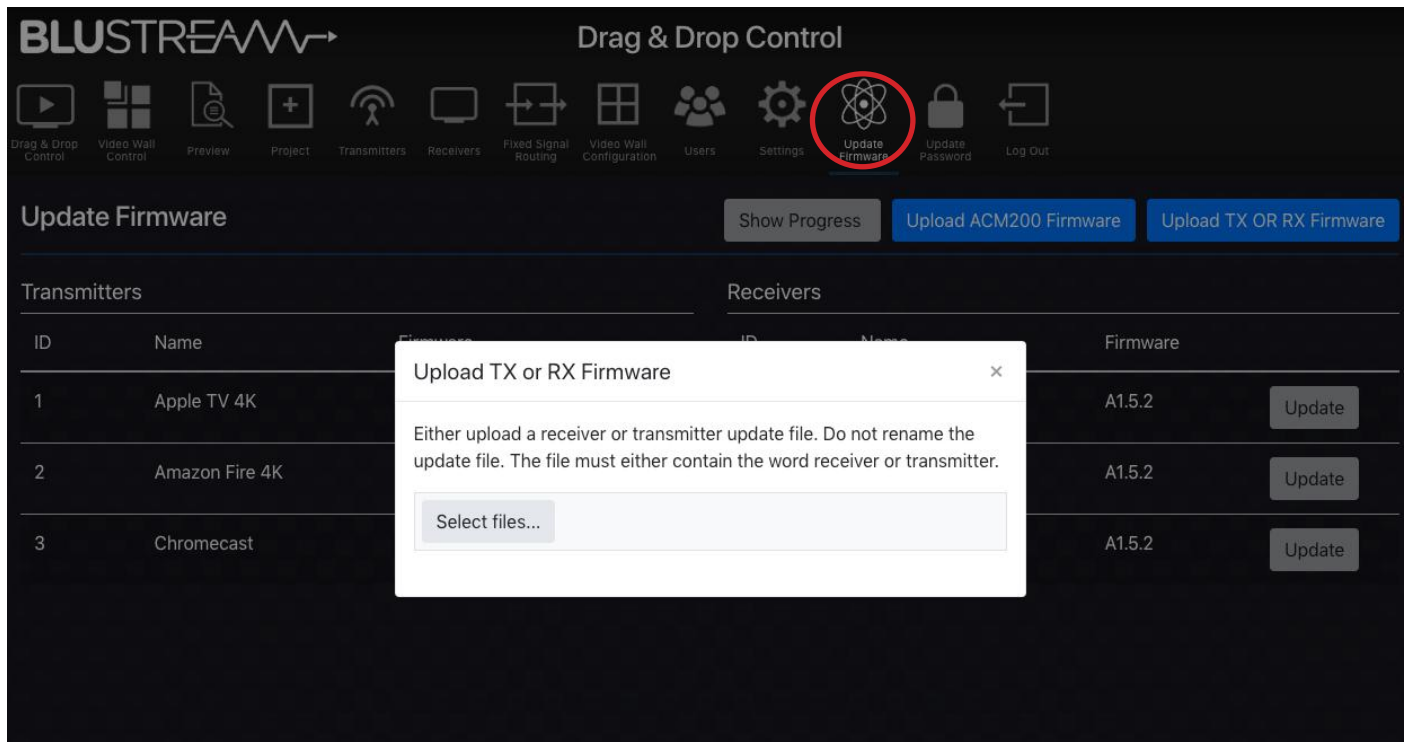

To upload the firmware files, click the button marked 'Upload TX or RX Firmware', then 'Select Files'. Once the correct firmware (.bin) file has been selected from the computer, the firmware will upload to the ACM200.

Please note: this part of the upgrade does not upload the firmware into the TX or RX units, it only uploads to the ACM200 ready for deployment to the TX or RX.

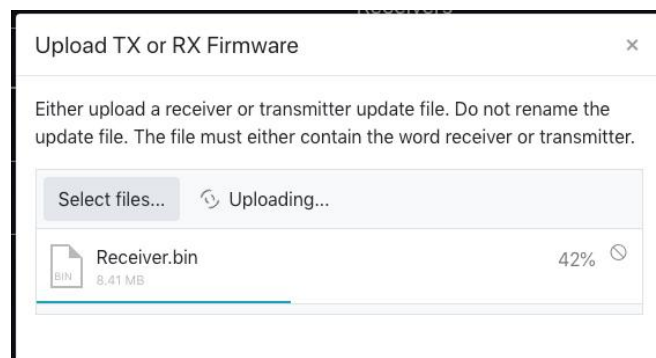

IMPORTANT: Do not close or navigate away from the upload whilst in progress to avoid firmware data being lost during transfer to the ACM200.

Web-GUI - Update Firmware - continued...

On completion of the firmware files being uploaded to the ACM200, a notification will appear on screen to feedback the success of the upload:

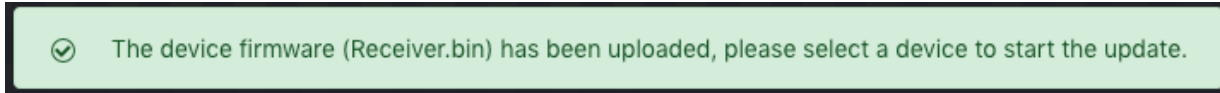

To complete the upgrade of the firmware of either the Multicast Transmitter, or for Receiver units, click the button marked 'Update' next to the relevant Transmitter or Receiver. **Please note:** it is only possible to update Transmitters, or Receivers at one time. The firmware upgrade process will then begin:

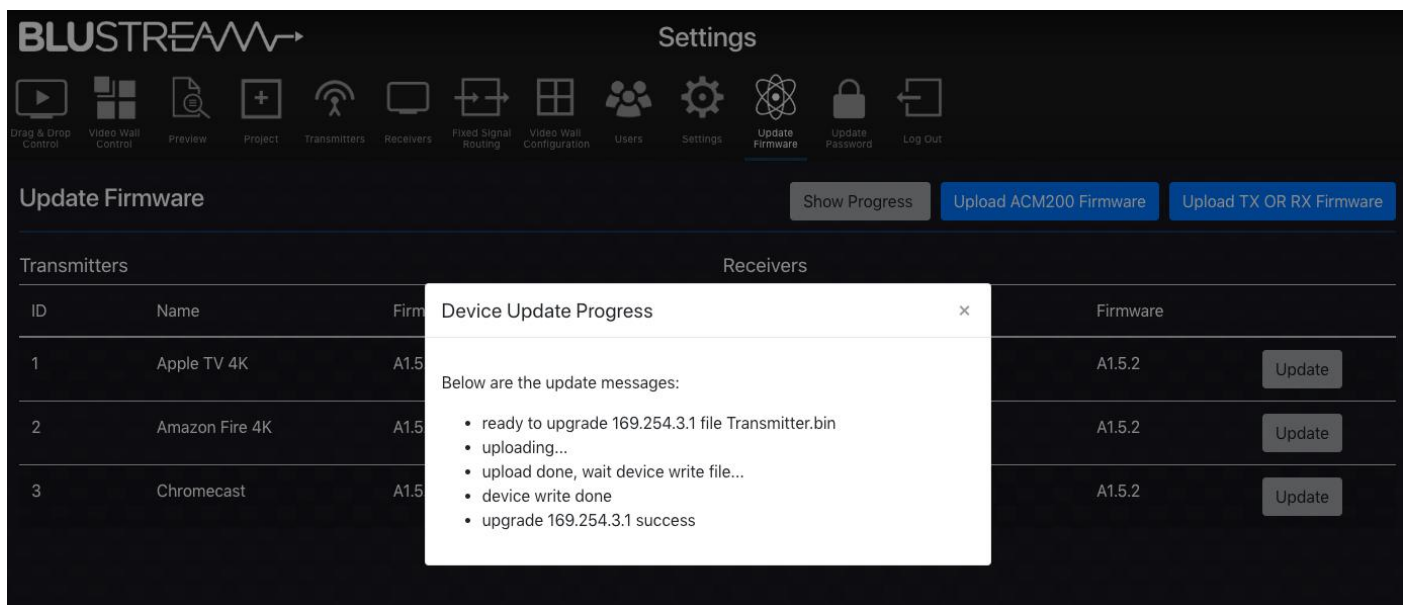

IMPORTANT: Do not disconnect the ACM200 or TX / RX units whilst in the upgrade process is in progress to avoid firmware data being lost during transfer to the individual Transmitter / Receiver devices.

Update Password

The Admin password for the ACM200 can be updated to an alpha-numeric password by inserting the new credentials in this pop-up menu option. Click 'Update Password' to confirm:

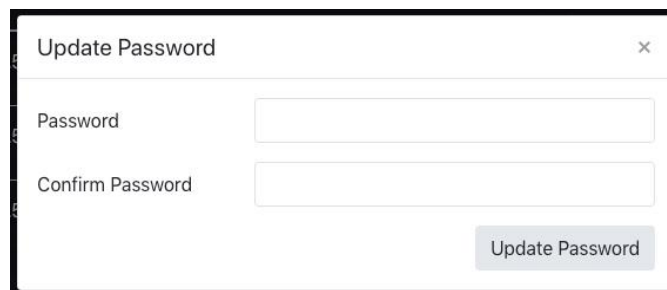

IMPORTANT: Once the Admin password has been changed, it cannot be recovered by the User. If the Admin password is forgotten or lost, please contact a member of the Blustream Technical Support team who will be able to assist in the recovery of the Admin rights of the unit. See email addresses below:

RS-232 (Serial) Routing

The Multicast system features two ways of managing RS-232 command signals:

Type 1 - Fixed Routing:

A static fixed routing for distributing two-way RS-232 commands between a Multicast Transmitter to one multiple Receivers (Fixed Routing). Fixed routing can be left static between two or more products as a permanent connection for the transfer of RS-232 control data, this is configured using the Fixed Routing menu of the ACM200.

Type 2 - Guest Mode:

Allows the RS-232 connection of a device to be sent over the IP network (IP / RS-232 command in, to RS-232 out). Type 2 Guest Mode gives third party control systems the ability to send an RS-232 or IP command to the ACM200 and an RS-232 command to be sent out of a Receiver or Transmitter as a result. This IP to RS-232 signalling, allows the third party control system to have control of as many RS-232 devices as there are Receivers and Transmitters, from the network connection to the ACM200.

There are two ways of enabling Type 2 - Guest Mode:

1. Using the ACM200 web-GUI. See page 20 for enabling Guest Mode on a Transmitter and page 23 for enabling Guest Mode on a Receiver unit.
2. Via the command set as detailed below. The command to configure the connection is: **IN/OUT xxx SG ON**

RS-232 Guest Mode Connection from a Third Party Control System:

When using Guest Mode on multiple devices within a system, we would recommend turning Guest Mode on and off when required. This is because a serial command being sent into the ACM200 will be passed to ALL devices that have Guest Mode enabled.

1. To open a Guest Mode connection between the ACM200 and an IPxxxUHD-TX or RX unit the following command must be sent via IP or RS-232:

INxxxGUEST Connect to TX xxx in Guest Mode from the ACM200

OUTxxxGUEST Connect to RX xxx in Guest Mode from the ACM200

Example: Transmitter ten is ID 010, meaning 'IN010GUEST' will allow bi-directional Serial / IP commands to be sent between the ACM200 and Transmitter 10.

2. Once a connection is established, any characters that are sent from the ACM200 will be transmitted to the connected Transmitter or Receiver, and vice versa.
3. To close the connection send the escape command: 0x02 (02 in Hex). If using Telnet, the connection can also be closed by pressing: CTRL + B.

Specifications

ACM200

- Ethernet port: 2x LAN RJ45 connector (1x PoE support)
 - RS-232 serial port: 1x DB-9 female
 - RS-232 & I/O port: 1x 6-pin Phoenix connector (reserved for future use)
 - IR input port: 1x 3.5mm stereo jack
 - Dimensions (W x D x H): 96mm x 110mm x 26mm
 - Shipping weight (Kit): 0.6kg
 - Operating temperature: 32°F to 104°F (0°C to 40°C)
 - Storage temperature: -4°F to 140°F (-20°C to 60°C)
-

Package Contents

- 1 x ACM200
 - 1 x IR control cable - 3.5mm to 3.5mm stereo to mono cable
 - 1 x 6-pin phoenix connector
 - 1 x Mounting kit
-

Maintenance

Clean this unit with a soft, dry cloth. Never use alcohol, paint thinner or benzene to clean this unit.

Blustream Infrared Commands

Blustream have created 16x input & 16x output IR commands allowing source selection of up to 16x IPxxxUHD-TX Transmitters on up to 16x IPxxxUHD-RX Receivers. These are different to the source switching controls sent to a Multicast Receiver.

For systems larger than 16x source devices (IPxxxUHD-TX), please use RS-232 or TCP/IP control.

For the complete database of Multicast IR commands, please visit the Blustream website page for any Multicast product, click on the "Drivers & Protocols" button, and navigate to the folder named "Multicast IR Control".

RS-232 and Telnet Commands

The Blustream Multicast system can be controlled via serial and TCP/IP. Please refer to the RS-232 connections page towards the start of this manual for settings and pin out. The following pages list all available serial commands for the Multicast solution when using the ACM200.

Common Mistakes

- Carriage return – Some programs do not require the carriage return where as other will not work unless sent directly after the string. In the case of some Terminal software the token <CR> is used to execute a carriage return. Depending on the program you are using this token maybe different. Some other examples that other control systems deploy include \r or 0D (in hex).
- Spaces – the ACM200 can work with our without spaces. It simply ignores them. It can also work with 0 to 4 digits.
 - eg: 1 is the same as 01, 001, 0001
 - How the string should look is as follows OUT001FR002
 - How the string may look if spaces are required by the control system: OUT{Space}001{Space}FR002
- Baud Rate or other serial protocol settings not correct

Blustream ACM200 commands and feedback

The following pages list the common API commands that will be required for third party control systems

Please note: the maximum number of Transmitters (yyy) and Receivers (xxx) = 762 devices (001-762)

- Receivers (outputs) = xxx
- Transmitters (inputs) = yyy
- Scaler Output = rr
- EDID Input settings = zz
- Baud Rate = br
- GPIO input/output ports = gg

For a full list of all API commands for the ACM200, please see separate Advanced Control Module API Document published on the Blustream website.

Receiver (Output) Commands

COMMAND DESCRIPTION	COMMAND	RESPONSE
Set OUTPUT:xxx From INPUT:yyy (ALL signals routed)	OUTxxxFRyyy	Set output xxx From INPUT:yyy
Fix VIDEO OUTPUT:xxx From INPUT:yyy	OUTxxxVFRyyy	Set output video xxx From INPUT:yyy
Fix AUDIO OUTPUT:xxx From INPUT:yyy	OUTxxxAFRyyy	Set output audio xxx From INPUT:yyy
Fix IR OUTPUT:xxx From INPUT:yyy	OUTxxxRFRyyy	Set output IR xxx From INPUT:yyy
Fix RS232 OUTPUT:xxx From INPUT:yyy	OUTxxxSFRyyy	Set output RS232xxx From INPUT:yyy
Fix USB OUTPUT:xxx From INPUT:yyy	OUTxxxUFRyyy	Set output usb xxx From INPUT:yyy
Fix CEC OUTPUT:xxx From INPUT:yyy	OUTxxxCFRyyy	Set output cec xxx From INPUT:yyy
Set CEC OUTPUT:yyy ON or Off	OUTxxxCECON/OFF	Set output xxx cec mode ON/OFF
Set OUTPUT:xxx Fast Switching On or Off	OUTxxxFASTON/OFF	Set output xxx fast switching mode ON/OFF
Set OUTPUT:xxx HDR On or Off	OUTxxxHDRON/OFF	Set output xxx hdr mode ON/OFF
Reboot Receiver	OUTxxxRB	Set output xxx reboot and apply all the new config
Rotate Receiver Video Output tt=0: clockwise 0 degree rotate tt=90: clockwise 90 degree rotate tt=180: clockwise 180 degree rotate tt=270: clockwise 270 degree rotate	OUTxxxROTATEtt	output xxx rotate tt degree
Stretch video Output (keep aspect ratio stretch to fit)	OUTxxxSTRETCHON/OFF	Set output xxx stretch ON/OFF
Switch Receiver (Output) between Matrix and Video Wall mode	OUTxxxMODEMX/VW	Set output xxx to matrix/video wall mode
Receiver HDCP management mode	OUTxxxDBGON/OFF	Set output xxx debug mode ON/OFF
Set Scaler Output Resolution 0: Bypass 1: 2160p@30 2: 2160p@24 3: 1080p@50 4: 1080p@60 5: 1080i@50 6: 1080i@60 7: 720p@60 8: 720p@50 9: 1280x1024@60 10: 1024x768@60 11: 1360x768@60 12: 1440x900@60 13: 1680x1050@60	OUTxxxRESrr	Set output xxx resolution to bypass (=0) Set output xxx resolution to 2160p@30(=1) ETC
Single Receiver (output) status	OUTxxxSTATUS	(See status example at end of document)

Transmitter (Input) Commands

COMMAND DESCRIPTION	COMMAND	RESPONSE
Set CEC INPUT:yyy ON or Off	INyyyCECON/OFF	Set input xxx cec mode ON/OFF
Set TX Audio source to HDMI audio	INyyyAUDHDMI	Set Audio source:xxx to audio select hdmi
Set TX Audio source to Analog	INyyyAUDANA	Set Audio source:xxx audio select analog
Set TX Audio source to Auto	INyyyAUDAUTO	Set Audio source:xxx audio select auto
Reboot Transmitter	INyyyRB	Set output xxx reboot and apply all the new config
Copy EDID Input yyy from Output xxx	EDIDyyyCPxxx	Copy outputxxx edid to input yyy
Set Input: yyy EDID To EDID:zz zz=00: HDMI 1080p@60Hz, Audio 2CH PCM zz=01: HDMI 1080p@60Hz, Audio 5.1CH PCM/DTS/ DOLBY zz=02: HDMI 1080p@60Hz, Audio 7.1CH PCM/DTS/DOLBY/HD zz=03: HDMI 1080i@60Hz, Audio 2CH PCM zz=04: HDMI 1080i@60Hz, Audio 5.1CH PCM/DTS/DOLBY zz=05: HDMI 1080i@60Hz, Audio 7.1CH PCM/DTS/DOLBY/HD zz=06: HDMI 1080p@60Hz/3D, Audio 2CH PCM zz=07: HDMI 1080p@60Hz/3D, Audio 5.1CH PCM/DTS/DOLBY zz=08: HDMI 1080p@60Hz/3D, Audio 7.1CH PCM/DTS/DOLBY/ HD zz=09: HDMI 4K@30Hz 4:4:4, Audio 2CH PCM zz=10: HDMI 4K@30Hz 4:4:4, Audio 5.1CH DTS/DOLBY zz=11: HDMI 4K@30Hz 4:4:4, Audio 7.1CH DTS/DOLBY/HD zz=12: DVI 1280x1024@60Hz, Audio None zz=13: DVI 1920x1080@60Hz, Audio None zz=14: DVI 1920x1200@60Hz, Audio None zz=15: HDMI 4K@30Hz 4:4:4, Audio 7.1CH(Default) zz=16: HDMI 4K@60Hz 4:2:0, Audio 2CH PCM zz=17: HDMI 4K@60Hz 4:2:0, Audio 5.1CH DTS/DOLBY zz=18: HDMI 4K@60Hz 4:2:0, Audio 7.1CH DTS/DOLBY/HD	EDIDyyyDFzz	Set input yyy edid with default edid zz
Single Transmitter (input) status	INyyySTATUS	(See status example at end of document)

Video Wall Commands

Video wall configurations will be setup in the ACM200 Web GUI

Each video wall setup will include the following:

- Video wall creation = each Multicast system can include up to 9x separate video walls (01-09)
- Configuration = individual configurations of screens within a video wall. An example of a configuration would be all screens assigned as a single video wall, all screens configured as individual displays, multiple video walls configured within a larger video wall (video wall groups – see below) (01-09)
- Groups = a video wall group is the ‘Grouping’ of Multicast receivers within a video wall allowing simplified source selection and configuration recall of more than one Multicast Receiver at the same time (A-J)

Video Wall 1 Configuration 1

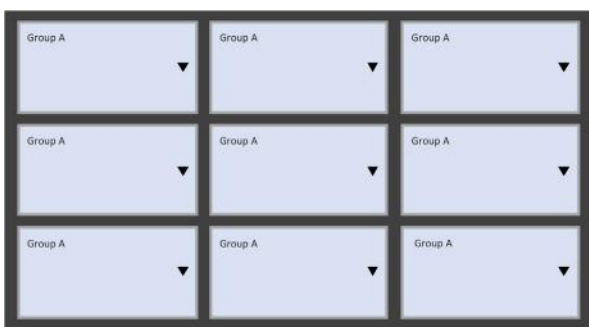

Video Wall 2 Configuration 2

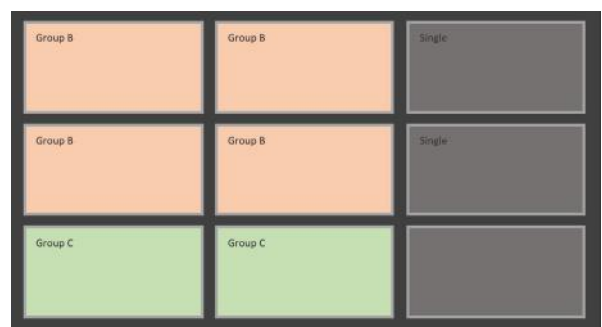

Example of control commands:

- VW01C01APPLY (will apply video wall configuration 1 above to all Receivers)
- VW01C02APPLY (will apply video wall configuration 2 above to all Receivers)
- VW01C01GaFR002 (will apply video configuration 1 and switch all screens to Transmitter 002)
- VW01C02GbFR006 (will apply video configuration 1 and switch group b screens [orange] to Transmitter 006)

When recalling video wall configurations the following applies:

Characters:

- idx = [01...09] - Video Wall Index / Number
- cidx = [01...09] - Config Index / Number
- gidx = [A...J] - Group Index / Number

COMMAND DESCRIPTION	COMMAND	RESPONSE
Apply Config to Video Wall	VW idx C cidx APPLY	Apply config: Configuration cidx
Set Grouped Output from Single Source INPUT:yyy	VW idx C cidx G gidx FR yyy	[SUCCESS] Done
ALL video wall status	VWSTATUS	(See status example at end of document)
Single Video Wall status	VWidxSTATUS	(See status example at end of document)

General ACM200 Commands

COMMAND DESCRIPTION	COMMAND	RESPONSE
Print all available commands of ACM200	HELP	(See HELP summary at end)
Turn IR control port On or Off	IRON/OFF	Set IR ON/OFF
Turn On Serial Guest Mode to Receiver (output) (NOTE: This only puts the RX into Serial Guest mode but doesn't open the connection. Please use command below) br=0: 300 br=1: 600 br=2:1200 br=3: 2400 br=4: 4800 br=5: 9600 br=6: 19200 br=7: 38400 br=8: 57600 br=9: 115200 bit= Data Bits + Parity + Stop Bits Example: 8n1 Data Bits=[5...8], Parity=[n o e], Stop Bits=[1..2]	OUTxxxSGON/OFF[br][bit]	Set serial guest mode config done
Serial Guest Mode to Transmitter (input) (details as above)	INxxxSGON/OFF[br][bit]	Set serial guest mode config done
Start Serial Guest Mode To Output ooo	OUT ooo GUEST	(no feedback when in guest mode)
Start Serial Guest Mode To Input ooo	IN ooo GUEST	(no feedback when in guest mode)
Close Serial Guest Mode	CLOSEACMGUEST	[Success] Exit guest
Set IO ports for use as input or output port gg=0: select all ports gg=01...04: select single IO port	GPIOggDIRIN/OUT	Set GPIO gg as input/output port
Set IO port to low(0) or high(1) level	GPIOggSET0/1	
Get IO port real input level	GPIOggGET	Get GPIO gg real input level 0/1
IO port status	GPIOggSTATUS	(See status example at end of document)
System status summary	STATUS	(See status example at end of document)
When command fails		unkown param. Type "HELP" for more reference Output xxx does not exist (RX has not been configured) Input yyy does not exist (TX has not been configured) Output xxx is offline Input yyy is offline Param range error (outside of given settings)

Status feedback samples

Command: STATUS

The STATUS feedback gives an overview of the network the ACM200 is connected to:

```
=====
IP Control Box ACM200 Status Info
FW Version: 1.14

Power IR Baud
On On 57600
In EDID IP NET/Sig
001 DF009 169.254.003.001 On /On
002 DF016 169.254.003.002 On /On

Out FromIn IP NET/HDMI Res Mode
001 001 169.254.006.001 On /Off 00 VW02
002 002 169.254.006.002 On /Off 00 VW02

LAN DHCP IP Gateway SubnetMask
01_POE Off 169.254.002.225 169.254.002.001 255.255.000.000
02_CTRL Off 010.000.000.225 010.000.000.001 255.255.000.000

Telnet LAN01 MAC LAN02 MAC
0023 34:D0:B8:20:4E:19 34:D0:B8:20:4E:1A
=====
```

Command: OUT xxx STATUS

The OUT xxx STATUS feedback gives an overview of the output (Receiver: xxx). Including: firmware, mode, fixed routing, name etc.

```
=====
IP Control Box ACM200 Output Info
FW Version: 1.14

Out Net HPD Ver Mode Res Rotate Name
001 On Off A7.3.0 VW 00 0 Receiver 001

Fast Fr Vid/Aud/IR_/Ser/USB/CEC HDR MCas
On 001 001/004/000/000/002/000 On On

CEC DBG Stretch IR BTN LED SGen/Br/Bit
On On Off On On 3 Off /9/8n1

IM MAC
Static 00:19:FA:00:59:3F

IP GW SM
169.254.006.001 169.254.006.001 255.255.000.000
=====
```

Status feedback samples

Command: IN xxx STATUS

An overview of the input (Transmitter: xxx). Including: firmware, audio, name etc.

```

=====
IP Control Box ACM200 Input Info

FW Version: 1.14

In Net Sig Ver EDID Aud MCast Name
001 On On A7.3.0 DF015 HDMI On Transmitter 001

CEC LED SGen/Br/Bit
On 3 Off /9/8n1

IM MAC
Static 00:19:FA:00:58:23

IP GW SM
169.254.003.001 169.254.003.001 255.255.000.000
=====
    
```

Command: VW STATUS

The VW STATUS will show all VW status feedback for Video Wall arrays in the system. Additional Video Wall arrays will have individual status feedback i.e. 'VW 2 STATUS'.

```

=====
IP Control Box ACM200 Video Wall Info

FW Version: 1.14

VW Col Row CfgSel Name
02 02 02 02 Video Wall 2

OutID
001 002 003 004

CFG Name
01 Configuration 1

Group FromIn Screen
A 004 H01V01 H02V01 H01V02 H02V02

02 Configuration 2

Group FromIn Screen
A 002 H02V01 H02V02
B 001 H01V01 H01V02
=====
    
```

Troubleshooting the ACM200

Try using the below instructions to test the ACM200 should difficulties be encountered when using a computer to control the ACM200.

1. Connect the computer directly to the ACM200 Control Port with a CAT cable
2. The computer must be in the same range as the LAN connection 1 on the ACM200 device (CONTROL network) as this will simulate the control from a third party control system (i.e. Control4, RTI, ELAN etc). Please see instructions at the rear of this manual for 'Changing your computer IP details'.
3. Open cmd.exe program (Command prompt). Use the search tool of the computer if unsure where this is located.

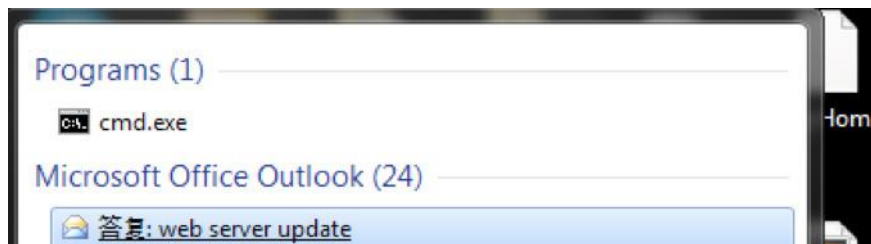

4. Enter the following command line 'Telnet 192.168.0.225'
The following window will be displayed to confirm being logged into the ACM200 successfully:

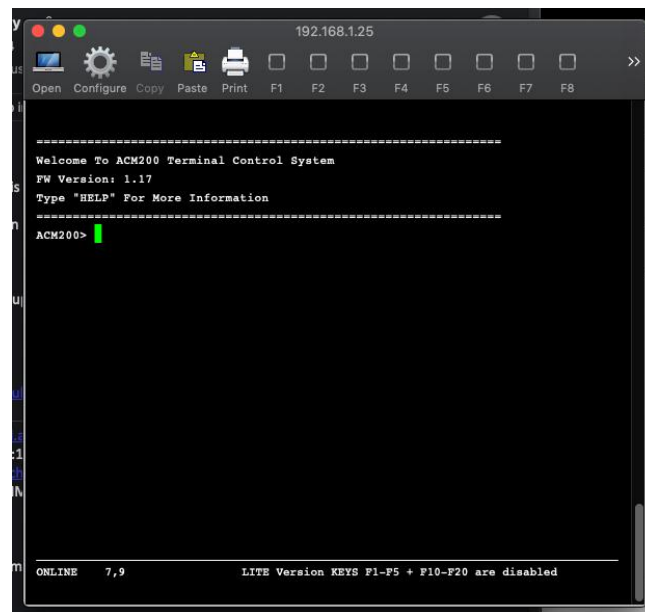

Telnet error

If the error message: *'telnet is not recognized as an internal or external command, operable program or batch file'*, activate Telnet on your computer.

Unable to see the LAN ports of the ACM200

If unable to communicate (ping) the ports of the ACM200, connect directly to the network switch and not via a DHCP modem router to test.

Able to ping the product but not login via Telnet connection

If unable to communicate (ping) the ports of the ACM200, connect directly to the network switch and not via a DHCP modem router to test.

Adjusting Your Computer Settings - Enabling TFTP & Telnet

Prior to using the Blustream ACM200 Firmware update PC program you must activate both TFTP and Telnet features on your computer. This is achieved using the following steps below:

1. In Windows, navigate to Start -> Control Panel -> Programs and Features
2. In the Programs and Features screen, select Turn Windows features on or off in the navigation bar on the left.

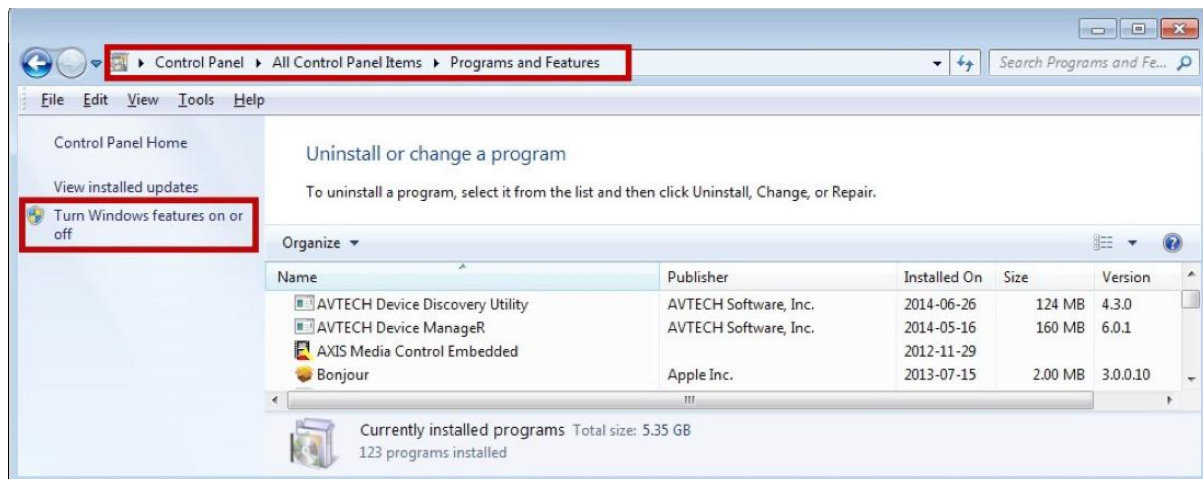

3. Once the Windows Features window populates, scroll down and make sure "TFTP client" and "Telnet Client" are both selected.

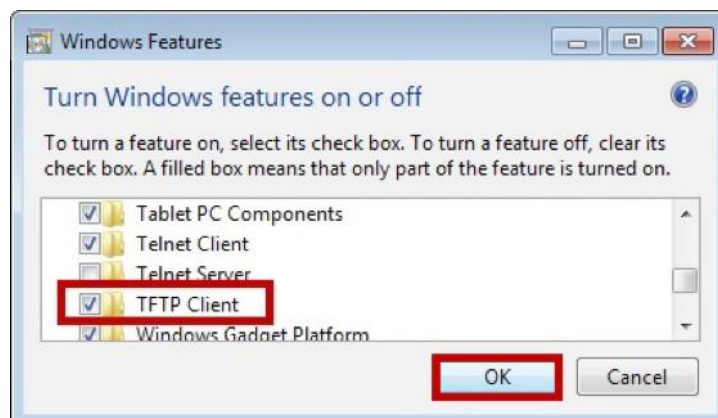

4. Once the progress bar fills and the pop up disappears, the TFTP client is enabled.

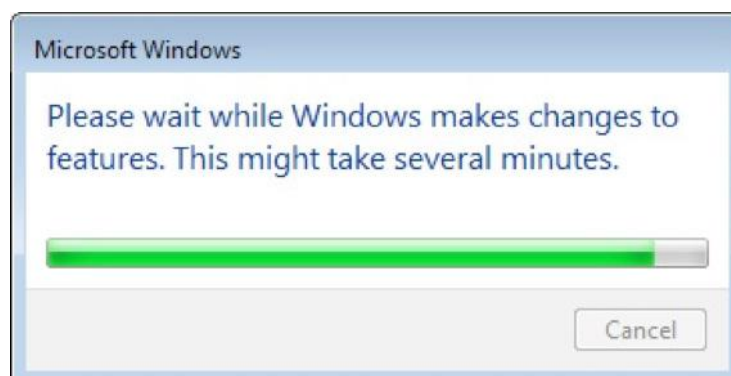

Setting a fixed IP address in Windows 7, 8 or 10

In order to communicate with the ACM200 your computer must first be in the same IP range as the ACM200 Control or Video LAN ports. By default the ports have the following IP address:

Control LAN port	192.168.0.225
Video LAN port	169.254.1.253

The following instructions allow you to manually alter the IP address of your computer allowing you to communicate with Blustream Multicast products.

1. In Windows, type 'network and sharing' into the search box

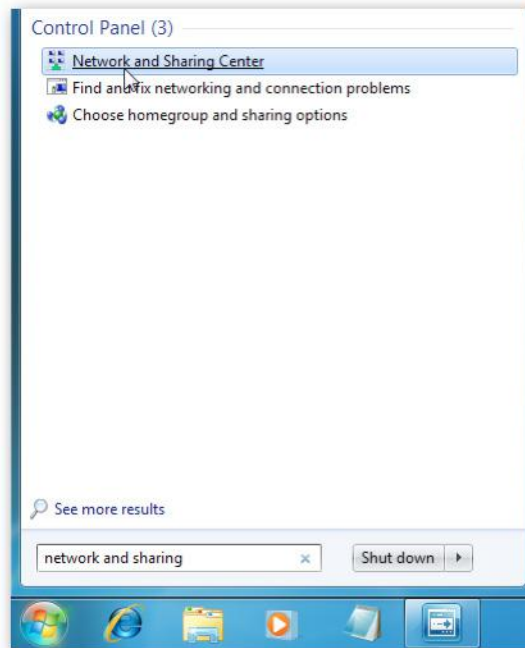

2. When the Network and Sharing screen opens, click on 'Change adapter settings'.

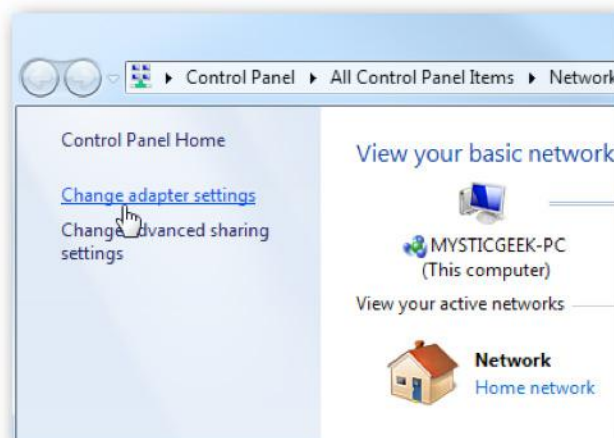

- Right click on your Ethernet adaptor and click Properties

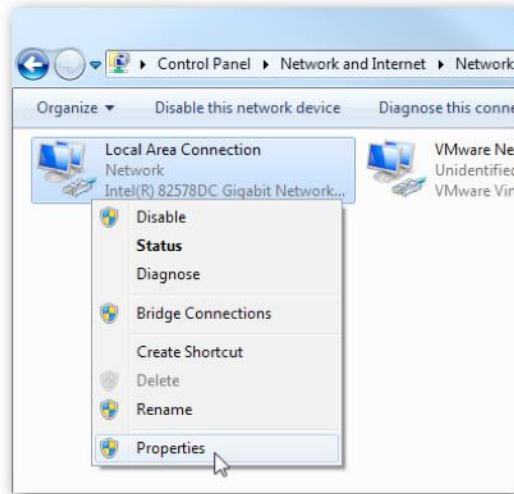

- In the Local Area Connection Properties window highlight Internet Protocol Version 4 (TCP/IPv4) then click the Properties button.

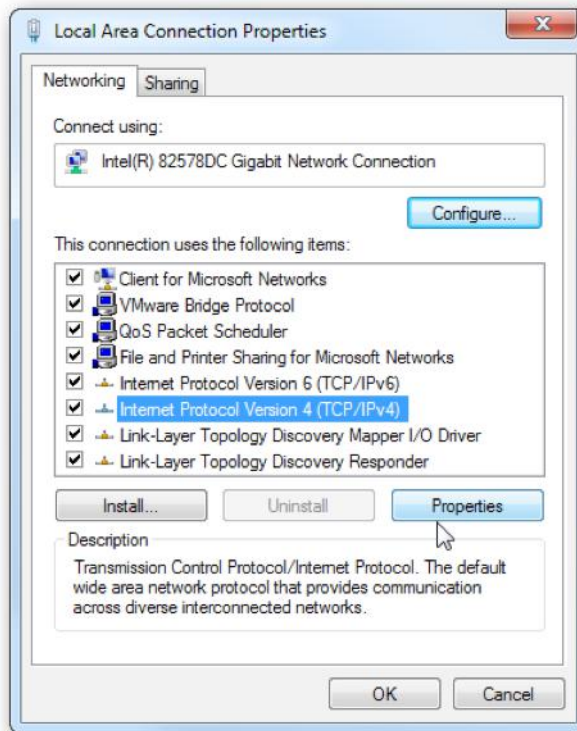

5. Select the radio button Use the following IP address and enter in the correct IP, Subnet mask, and Default gateway that corresponds with your network setup.

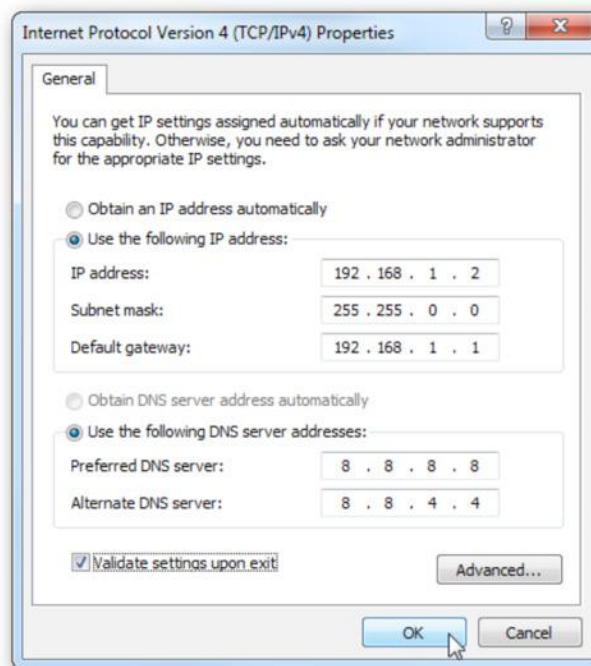

6. Press OK and close out of all network screens. Your IP address has now been fixed.



www.blustream.co.uk
www.blustream.com.au