



IOx Card

for VENUE Systems

Legal Notices

This guide is copyrighted ©2010 by Avid Technology, Inc., (hereafter "Avid"), with all rights reserved. Under copyright laws, this guide may not be duplicated in whole or in part without the written consent of Avid.

003, 96 I/O, 96i I/O, 192 Digital I/O, 192 I/O, 888|24 I/O, 882|20 I/O, 1622 I/O, 24-Bit ADAT Bridge I/O, AudioSuite, Avid, Avid DNA, Avid Mojo, Avid Unity, Avid Unity ISIS, Avid Xpress, AVoption, Axiom, Beat Detective, Bomb Factory, Bruno, C|24, Command|8, Control|24, D-Command, D-Control, D-Fi, D-fx, D-Show, D-Verb, DAE, Digi 002, DigiBase, DigiDelivery, Digidesign, Digidesign Audio Engine, Digidesign Intelligent Noise Reduction, Digidesign TDM Bus, DigiDrive, DigiRack, DigiTest, DigiTranslator, DINR, DV Toolkit, EditPack, Eleven, HD Core, HD Process, Hybrid, Impact, Interplay, LoFi, M-Audio, MachineControl, Maxim, Mbox, MediaComposer, MIDI I/O, MIX, MultiShell, Nitris, OMF, OMF Interchange, PRE, ProControl, Pro Tools M-Powered, Pro Tools, Pro Tools|HD, Pro Tools LE, QuickPunch, Recti-Fi, Reel Tape, Reso, Reverb One, ReVibe, RTAS, Sibelius, Smack!, SoundReplacer, Sound Designer II, Strike, Structure, SYNC HD, SYNC I/O, Synchronic, TL Aggro, TL AutoPan, TL Drum Rehab, TL Everyphase, TL Fauxlder, TL In Tune, TL MasterMeter, TL Metro, TL Space, TL Utilities, Transfuser, Trillium Lane Labs, Vari-Fi Velvet, X-Form, and XMON are trademarks or registered trademarks of Avid Technology, Inc. Xpand! is Registered in the U.S. Patent and Trademark Office. All other trademarks are the property of their respective owners.

Product features, specifications, system requirements, and availability are subject to change without notice.

Guide Part Number 9321-62790-00 REV A 08/10

Documentation Feedback

At Avid, we are always looking for ways to improve our documentation. If you have comments, corrections, or suggestions regarding our documentation, email us at techpubs@avid.com.

Contents

Chapter 1. Overview	1
IOx Card Components	1
IOx Card Features and Capabilities	1
System Requirements and Compatibility	2
Registration	2
Conventions Used in This Guide	2
About www.avid.com	3
Chapter 2. Installing an IOx Card	5
Installing an IOx Card in FOH Rack	5
Installing an IOx Card in Mix Rack	7
IOx Connections	11
Chapter 3. Specifications	13
Audio and Electrical Specifications	13
Appendix A. Compliance Information	15
Environmental Compliance	15
EMC (Electromagnetic Compliance)	15
Safety Compliance	16

Chapter 1: Overview

The IOx card expands your FOH Rack or Mix Rack analog and digital I/O capabilities, providing eight AES digital inputs and outputs and eight pairs of analog inputs and outputs (via 1/4-inch TRS jacks). This additional I/O can be used to connect digital and analog outboard equipment to your system local to the console. All digital and analog I/O are digitally controlled, fully recallable and fully routable from your console software.

For IOx card installation instructions, see Chapter 2, “Installing an IOx Card.”.

IOx Card Components

The IOx card package includes the following items:

- IOx card
- Ribbon cables, 40-pin (x2)
- Mounting screws
- Mounting brackets (for installation in a Mix Rack)
- Power cable splitter
- Registration Information Card

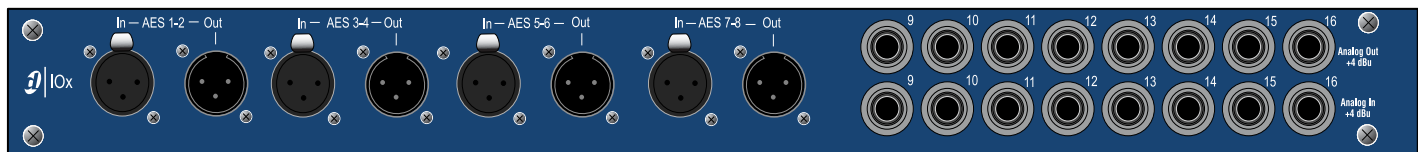

Figure 1. IOx card

IOx Card Features and Capabilities

- Eight channels of AES3 digital outputs via four XLR3-male connectors. Each connector carries two digital audio channels.
- Eight channels of AES3 digital inputs via four XLR3-female connectors. Each connector carries two digital audio channels.
- Sample Rate Conversion (SRC) on digital inputs.
- Eight channel pairs of analog I/O via 1/4-inch balanced TRS connectors.

System Requirements and Compatibility

Avid can only assure compatibility and provide support for hardware and software it has tested and approved.

For complete system requirements and a list of qualified computers, operating systems, hard drives, and third-party devices, visit:

www.avid.com/compatibility

Registration

Review the enclosed Registration Information Card and follow the instructions on it to quickly register your purchase online. By registering, you become eligible to receive the following:

- Technical support information
- Software update and upgrade notices
- Hardware warranty information

Conventions Used in This Guide

All of our guides use the following conventions to indicate menu choices and key commands:

Convention	Action
File > Save	Choose Save from the File menu
Control+N	Hold down the Control key and press the N key
Control-click	Hold down the Control key and click the mouse button
Right-click	Click with the right mouse button

The names of Commands, Options, and Settings that appear on-screen are in a different font.

The following symbols are used to highlight important information:

 *User Tips are helpful hints for getting the most from your system.*

 *Important Notices include information that could affect your data or the performance of your system.*

 *Shortcuts show you useful keyboard or mouse shortcuts.*

 *Cross References point to related sections in this guide and other VENUE guides.*

About www.avid.com

The Avid website (www.avid.com) is your best online source for information to help you get the most out of your system. The following are just a few of the services and features available.

Product Registration Register your purchase online.

Support and Downloads Contact Customer Success (technical support); download software updates and the latest online manuals; browse the Compatibility documents for system requirements or search the online Knowledgebase.

Training and Education Study on your own using courses available online or find out how you can learn in a classroom setting at a certified Avid training center.

Products and Developers Learn about Avid products; download demo software or learn about our Development Partners and their plug-ins, applications, and hardware.

News and Events Get the latest news from Avid or sign up for a product demo.

Pro Tools Accelerated Videos Watch the series of free tutorial videos. Accelerated Videos are designed to help you get up and running with Pro Tools and its plug-ins quickly.

Live Sound Webinars Watch free tutorial videos and VENUE-specific webinars to learn from the experts.

To learn more about these and other resources available from Avid, visit our website (www.avid.com).

Chapter 2: Installing an IOx Card

For IOx card installation into an FOH Rack, see “Installing an IOx Card in FOH Rack” on page 5.

For IOx card installation into a Mix Rack, see “Installing an IOx Card in Mix Rack” on page 7.

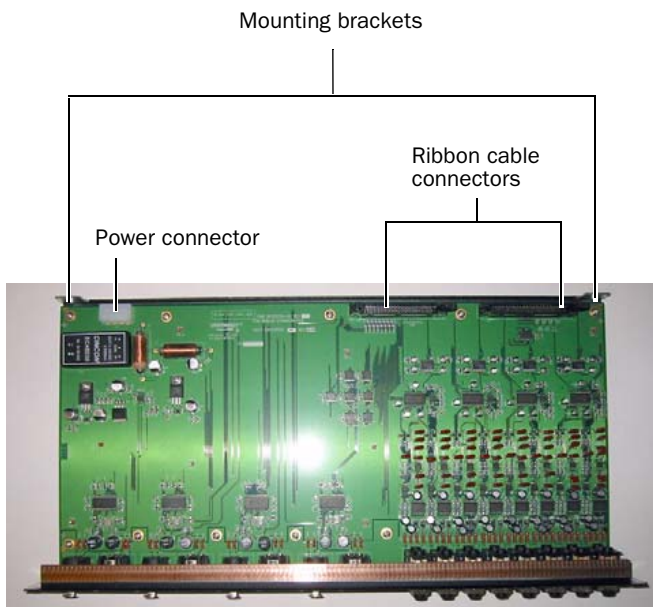

IOx card showing brackets and connectors

Installing an IOx Card in FOH Rack

The IOx card is installed in the FOH Rack and connected with two ribbon cables to the IO card already installed in the rack.

To install the IOx card:

- 1 Shut down your sound system.
- 2 Disconnect all audio and power cables attached to the FOH Rack.

- 3 Remove the FOH Rack front panel faceplate by unscrewing its mounting screws (#1 Phillips).

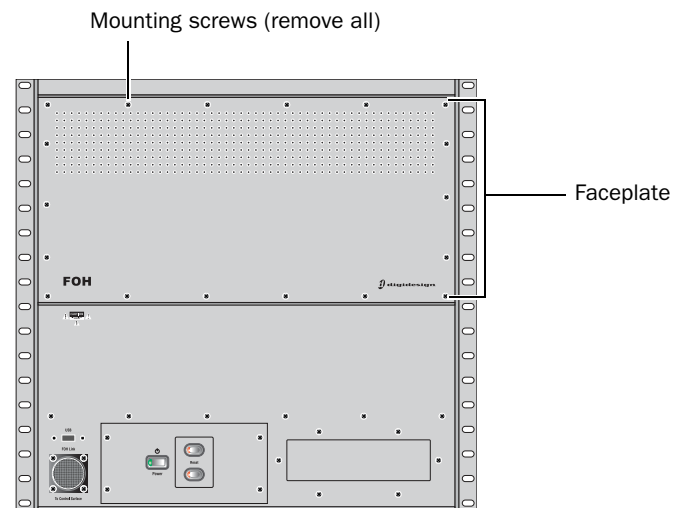

Front panel of the FOH Rack

- 4 On the back panel of the FOH Rack, remove the IOx card expansion slot cover by removing the four screws holding it in place. Keep the screws nearby for securing the IOx card to the FOH Rack later.

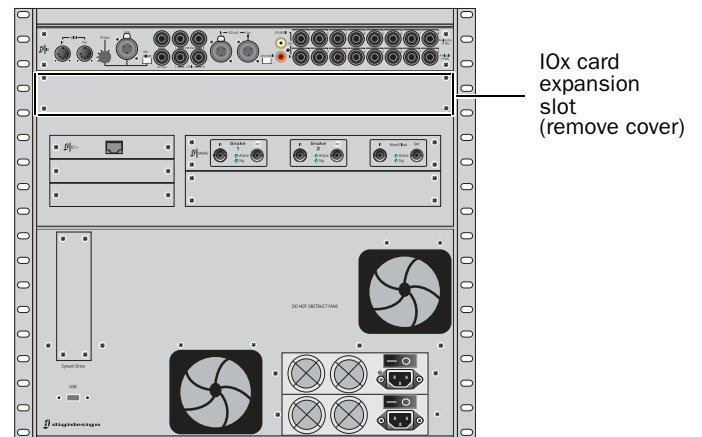

Back panel of the FOH Rack

- 5 Remove the IOx card from its packing material. Hold the card by its edges.

6 Gently slide the card into the IOx card expansion slot.



Installing the IOx card in the FOH Rack

7 When the card is seated in its slot, secure it to the inside of the FOH Rack chassis with two provided mounting screws at both sides of the IOx card (accessible from the open front panel of the FOH Rack).



Securing the IOx card to the FOH Rack chassis

8 Secure the IOx card to the back panel of the FOH Rack using the four screws that held the slot cover.



Securing the IOx card to the back panel of the FOH Rack

9 Connect the IOx card to the IO card immediately above it with the two provided ribbon cables. Make sure the keyed connector is oriented correctly in each socket. Secure each connection by moving the tabs on each side of the connector inward. Check to make sure the cables are connected securely.

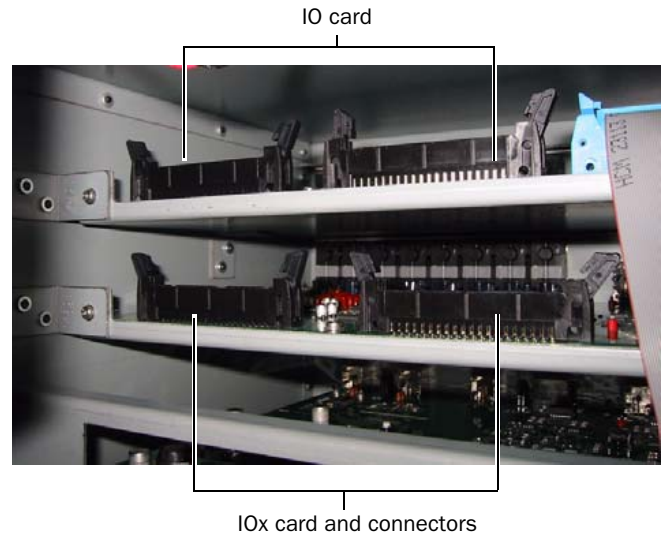

Connectors on the IO card (top) and the IOx card (bottom)



Ribbon cables connecting the IOx card to the IO card

10 Plug an available power connector in the FOH Rack into the power socket on the IOx card. Make sure it is connected securely.

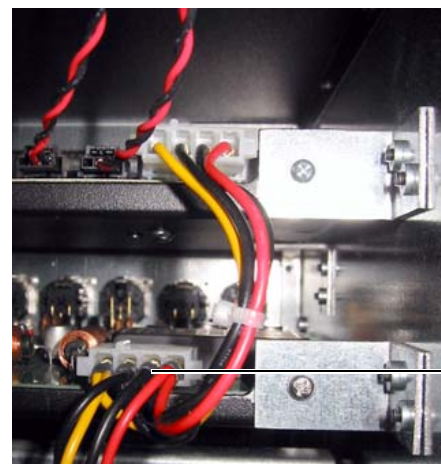

Power connection to the IOx card

Confirming Installation

After installing the IOx card, you should confirm that you have installed it properly. You can confirm installation by checking your system hardware status.

To complete and confirm installation:

- 1 Reattach the FOH Rack faceplate.
- 2 Reconnect the power, FOH Link, and any audio and MIDI cables to the FOH.
- 3 Turn on your FOH Rack.
- 4 In the console's software, go to the Options page and click the Devices tab to view your system hardware status. The IOx card should be indicated in the FOH Rack graphic.



Detail of Devices page indicating presence of an IOx card

The corresponding inputs and outputs should also become available in the "FOH" tab in the Patchbay.

Installing an IOx Card in Mix Rack

This section explains how to perform each of the following tasks required to install an IOx card into a Mix Rack:

Prepare the Mix Rack Shut down, disconnect cables, remove front and back face plates.

Rearrange Existing IO Cards Remove and reinstall existing cards and brackets.

Install the IOx Card Install new brackets, install the IOx card, connect cables.

Confirm Installation Power up VENUE and verify installation.

Prepare the Mix Rack

To install an IOx card:

- 1 Shut down the VENUE system, and turn off power to the Mix Rack.
- 2 Disconnect all cables from Mix Rack.
- 3 Remove the Mix Rack's front panel cover by unscrewing its mounting screws (#1 Phillips).

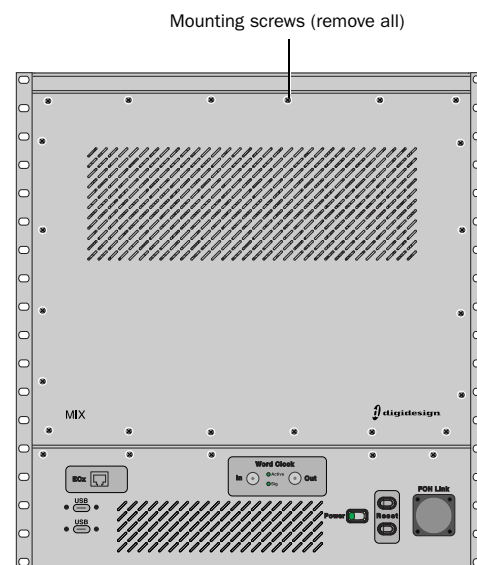

Mix Rack front panel

4 On Mix Rack's back panel, identify each input/output slot (A–E).

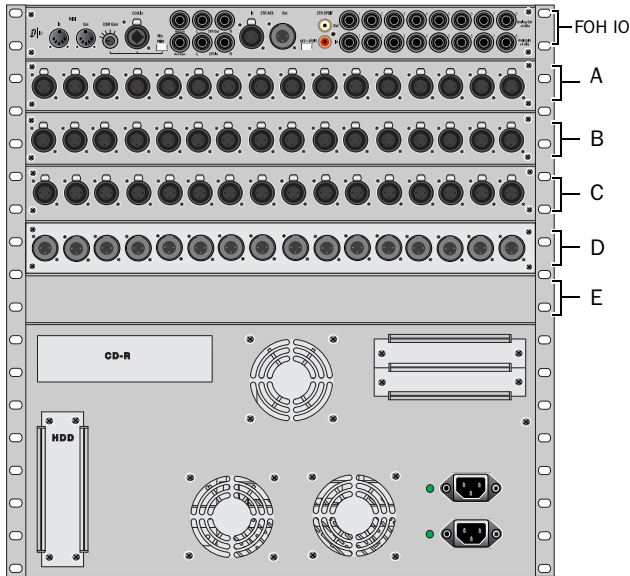

Mix Rack back panel slots A–E

Rearrange Existing IO Cards

Overview

IOx must be installed in slot A (the topmost Input slot, below the FOH IO card). The recommended way to install the IOx card is to first remove the AO16 Output card from slot D and install it into slot E, then move the first AI16 Input card from slot A to slot D. Your configuration may vary, depending on whether you have already added or replaced input or output cards.

 This guide explains how to rearrange cards within a default, factory Mix Rack with three AI16 input cards and a single AO16 output card.

To rearrange existing IO cards:

1 From the front of the Mix Rack, carefully disconnect the 50-pin ribbon cables attached to each input and output card. Each 50-pin ribbon cable connects to a port on the Hub 48 board, and each Hub 48 port is identified by letter (Slot A, Slot B, Slot C, Slot D, and Slot E). Leave cables connected to the Hub 48 board; these will be reconnected to the I/O cards later.

2 Remove the mounting screws that secure the AO16 output card (Slot D) to the front panel of Mix Rack's chassis, then inside the Mix Rack do the following:

- Disconnect the card's ribbon cable.
- Loosen the thumbscrews that secure the card to the Mix Rack's chassis.
- Gently slide the card out of the slot.

3 Remove the faceplate (or card, if any) from slot E by removing its mounting screws (and ribbon cable, if any) and removing it from the Mix Rack.

4 Gently slide the output card into slot E (the lowest slot), then do the following:

- Tighten the thumbscrews that secure the card to the Mix Rack chassis.
- Secure the card to the Mix Rack chassis using the four mounting screws you removed earlier.

5 Next, remove the mounting screws that secure the top most input card (Slot A) to the front panel of Mix Rack's chassis, then inside the rack do the following:

- Disconnect the card's ribbon cable.
- Loosen the thumbscrews that secure the card to the Mix Rack's chassis.
- Gently slide the card out of the slot and set it aside.

6 Locate the two interior brackets attached to the sides of Mix Rack in slot D, where the output card had been, and use a #1 Phillips screwdriver to remove them.

7 Next, locate the two interior brackets attached to the sides of Mix Rack in slot A (where the input card had been), and do the following:

- Use a #1 Phillips screwdriver to remove the brackets from slot A.
- Move these brackets to slot D and use a #1 Phillips screwdriver to attach them to the Mix Rack chassis.

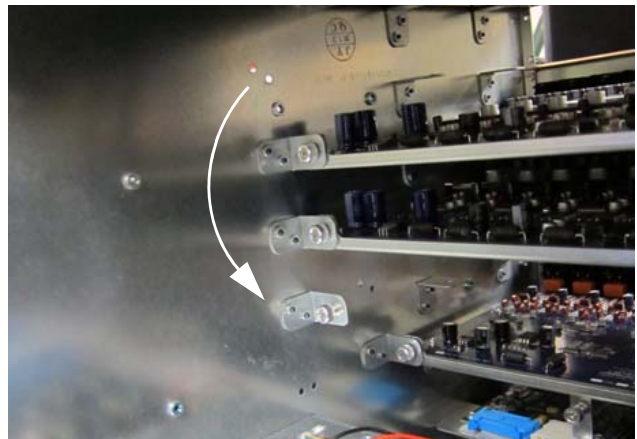

Moving brackets to slot D

8 With the brackets moved to slot D, gently slide the AI16 card into slot D and do the following:

- Tighten the captive thumbscrews that secure the card to the Mix Rack's chassis.
- Secure the card to the Mix Rack chassis using the four mounting screws you removed earlier.

9 Reattach the ribbon cables removed in step 1 to each of the IO cards:

- Start with the ribbon cable connected to port A on the Hub 48 board (the lowest port on the board), and connect it to the topmost AI16 card.
- Connect the ribbon cable connected to port B on the Hub 48 board to the second AI16 card.
- Connect the ribbon cable connected to port C on the Hub 48 board to the third AI16 card.
- Lastly, connect the ribbon cable connected to port D on the Hub 48 board to the AO16 output card.

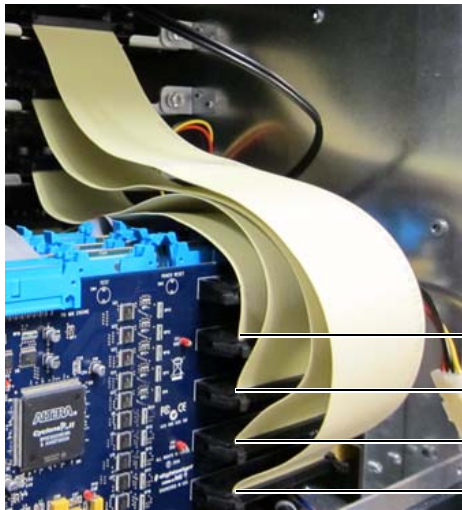

- Connect to card in Slot E
- Connect to card in Slot D
- Connect to card in Slot C
- Connect to card in Slot B

Ribbon cables reattached

💡 *Mix Rack contains 5 ribbon cables to connect to input and output cards. Only 4 of these ribbon cables are used when an IOx card is installed; the fifth (connected to port E on the Hub 48 board) should be left unattached to any IO card.*

Make sure the pins on the socket are correctly aligned with the ribbon cable connector. Secure the connection by moving the retaining clips on each side of the socket connector inward. Check to make sure the ribbon cable is connected securely.

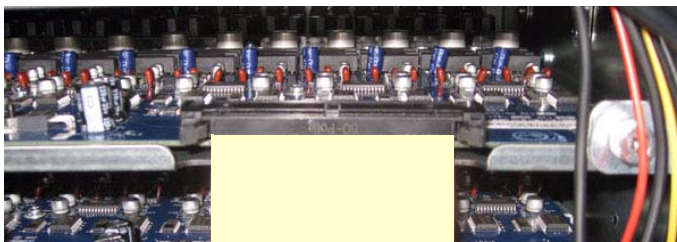

A properly connected Expansion Card

Install the IOx Card

This section shows how to install new brackets, install the IOx card, and connect it to the Mix Rack.

To install the IOx card:

- 1 Remove the card from its packing material. Hold the card by its edges and set it aside.
- 2 Locate the included mounting brackets and remove them from their packaging.



Bracket (one of two) included with the IOx card

3 Attach the IOx mounting brackets to the interior sides of the Mix Rack in slot A, using a #1 Phillips screwdriver and the included screws.

4 Gently slide the IOx card into the slot A.



Sliding the IOx card into Slot A

5 When the card is seated in its slot, use the captive thumb-screws on the brackets installed in step 3, above, to secure the card to Mix Rack's chassis.

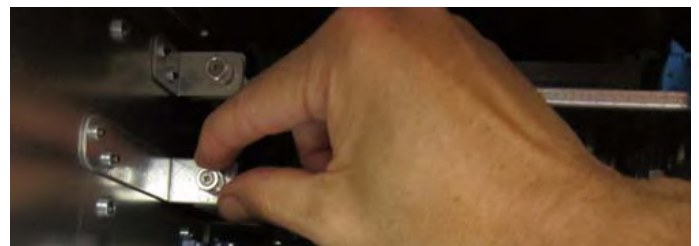

Securing the IOx card to its mounting brackets

6 Secure the card to the front panel of Mix Rack using the four mounting screws you removed earlier.

7 Attach the two IOx card ribbon cables to the FOH IO card directly above it by doing the following:

- Take one of the included ribbon cables and attach it to one of the two 40-pin sockets on the IOx card, then attach the other end to the corresponding 40-pin socket on the FOH IO card (directly above the IOx card).

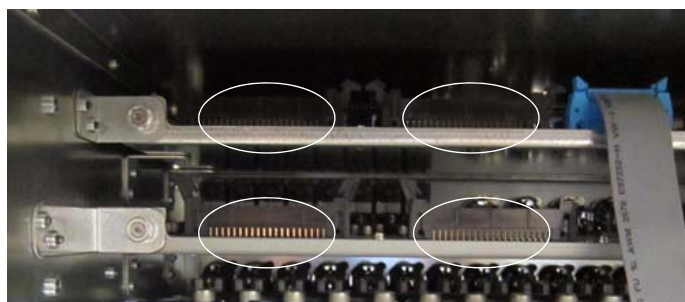

40-pin sockets on IOx (lower) and FOH IO card (upper)

- Repeat for the other ribbon cable, attaching the other IOx socket to the corresponding FOH IO socket.



IOx ribbon cables connected to FOH IO card

8 From the back of the Mix Rack, locate the FOH IO power cable and unplug it from the FOH IO card (the power cable is at the far right of the card, when viewing from the back of the Mix Rack).

9 Take the included power cable splitter and attach the single end to the power cable you just unplugged (as shown in Figure 2).

10 Attach one of the “y” ends of the power cable splitter to the power cable socket on the IOx card. (See Figure 2.)

11 Attach the other “y” end of the power cable splitter to the power socket on the FOH IO card. (See Figure 2.)

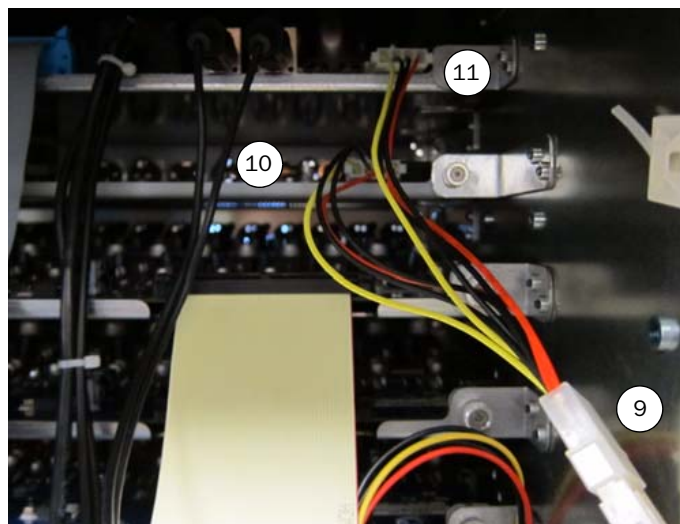

Figure 2. Power connections

Confirm Installation

After installing the IOx card, you should confirm that you have installed it properly. You can confirm installation by checking your system hardware status.

To complete and confirm installation:

- 1 Reattach the Mix Rack faceplate.
- 2 Reconnect the power, FOH Link, and any audio and MIDI cables to the Mix Rack.
- 3 Turn on your Mix Rack.
- 4 In the VENUE software, go to the Options page and click the Devices tab to view your system hardware status. The IOx card should be indicated in the Mix Rack graphic.

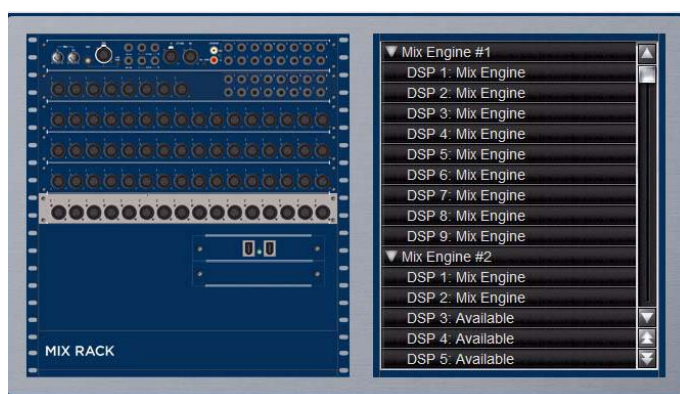

Detail of Devices page indicating presence of an IOx card

IOx inputs and outputs become available in the FOH tab and Insets tabs of the Patchbay.

- IOx digital inputs and outputs appear as AES 1–8.
- IOx analog inputs and outputs are numbered 9–16.

IOx Connections

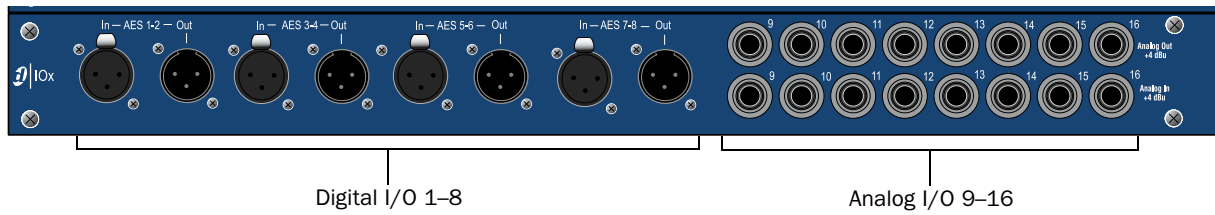

Audio connectors the IOx card

The IOx card lets you connect digital and analog outboard equipment to your FOH Rack. You can use these connections for hardware insert processing on individual input and output channels, or to patch processing to Aux busses and FX returns. IOx inputs and outputs can also be used as additional analog or digital inputs or outputs. Signal routing for the IOx is done on the console software's Patchbay page.

Using IOx, you can make the following types of connections to the FOH Rack or Mix Rack:

AES Digital Inputs and Outputs 1-8

(Balanced XLR Connectors)

⚠ The IOx card's digital inputs support 24-bit, 48 kHz digital signals. Input signals with other sample rates are sample-rate converted to 48 kHz.

- ◆ Connect the two-channel digital inputs and outputs of external processors to any of the AES/EBU digital output and input connectors.
- ◆ Connect any digital output destination (such as a recording device or broadcast feed) to any of the outputs in this section.
- ◆ Connect any digital sound source (such as a CD player) to any of the inputs in this section.

Analog Inputs and Outputs 9-16

(Balanced 1/4-inch TRS Connectors)

- ◆ Connect the analog inputs and outputs of external processors to any of these analog output and input pairs.
- ◆ Connect any analog output destination (such as a recording device or broadcast feed) to any of the outputs in this section.
- ◆ Connect any analog sound sources (such as a CD player) to any of the inputs in this section.

Chapter 3: Specifications

Audio and Electrical Specifications

IOx Card Analog Input

Parameter	Specifications	Limit	Units	Condition/ Comment
Connector (x8)	1/4" TRS			
Maximum Input Level	+24		dBu	
Input Impedance	10K		ohms	

IOx Card Analog Output

Parameter	Specifications	Limit	Units	Condition/ Comment
Connector (x8)	1/4" TRS			
Maximum Output Level	+24		dBu	
Output Impedance	50		ohms	

IOx Card Digital Input

Parameter	Specifications	Limit	Units	Condition/ Comment
Connector (x4)	XLR3-F			
Format	AES/EBU			
Word Length	24-bit			
Sample Rate	48kHz			

IOx Card Digital Output

Parameter	Specifications	Limit	Units	Condition/ Comment
Connector (x4)	XLR3-M			
Format	AES/EBU			
Word Length	24-bit			
Sample Rate	48kHz			
Sample Rate Conversion	Yes			
Dithering	No			
Channel Status Info	Pro, Audio, 48K			No Emphasis

Appendix A: Compliance Information

Environmental Compliance

Disposal of Waste Equipment by Users in the European Union



This symbol on the product or its packaging indicates that this product must not be disposed of with other waste. Instead, it is your responsibility to dispose of your waste equipment by handing it over to a designated collection point for the recycling of waste electrical and electronic equipment. The separate collection and recycling of your waste equipment at the time of disposal will help conserve natural resources and ensure that it is recycled in a manner that protects human health and the environment. For more information about where you can drop off your waste equipment for recycling, please contact your local city recycling office or the dealer from whom you purchased the product.

Proposition 65 Warning

⚠ *This product contains chemicals, including lead, known to the State of California to cause cancer and birth defects or other reproductive harm. Wash hands after handling.*

Perchlorate Notice

This product may contain a lithium coin battery. The State of California requires the following disclosure statement: "Perchlorate Material – special handling may apply, See www.dtsc.ca.gov/hazardouswaste/perchlorate."

Recycling Notice



EMC (Electromagnetic Compliance)

Avid declares that this product complies with the following standards regulating emissions and immunity:

- FCC Part 15 Class B
- EN55103-1 E3
- EN55103-2 E3
- AS/NZS 3548 Class B
- CISPR 22 Class B

FCC Compliance for United States

Radio and Television Interference

This equipment has been tested and found to comply with the limits for a Class B digital device, pursuant to Part 15 of the FCC Rules.

DECLARATION OF CONFORMITY

We, Avid, 2001 Junipero Serra Boulevard
Daly City, CA 94014-3886, USA
650-731-6300

declare under our sole responsibility that this product
IOx Card

complies with Part 15 of FCC Rules.

Operation is subject to the following two conditions:

- (1) this device may not cause harmful interference, and
- (2) this device must accept any interference received, including interference that may cause undesired operation.

Communication Statement

NOTE: This equipment has been tested and found to comply with the limits for a Class B digital device, pursuant to Part 15 of the FCC Rules. These limits are designed to provide reasonable protection against harmful interference in a residential installation. This equipment generates, uses, and can radiate radio frequency energy and, if not installed and used in accordance with the instructions, may cause harmful interference to radio communications. However, there is no guarantee that interference will not occur in a particular installation. If this equipment does cause harmful interference to radio or television reception, which can be determined by turning the equipment off and on, the user is encouraged to try and correct the interference by one or more of the following measures:

- Reorient or locate the receiving antenna.
- Increase the separation between the equipment and receiver.
- Connect the equipment into an outlet on a circuit different from that to which the receiver is connected.
- Consult the dealer or an experienced radio/TV technician for help.

Any modifications to the unit, unless expressly approved by Avid, could void the user's authority to operate the equipment.

Australian Compliance



Canadian Compliance

This Class B digital apparatus complies with Canadian ICES-003

Cet appareil numérique de la classe A est conforme à la norme NMB-003 du Canada

CE Compliance

(EMC and Safety)



Avid is authorized to apply the CE (Conformité Européenne) mark on this compliant equipment thereby declaring conformity to EMC Directive 89/336/EEC and Low Voltage Directive 2006/95/EEC.

Safety Compliance

Safety Statement

This equipment has been tested to comply with USA and Canadian safety certification in accordance with the specifications of UL Standards: UL60065 7th /IEC 60065 7th and Canadian CAN/CSA C22.2 60065:03. Avid Inc., has been authorized to apply the appropriate UL & CUL mark on its compliant equipment.

Warning



Important Safety Instructions

- 1) Read these instructions.
 - 2) Keep these instructions.
 - 3) Heed all warnings.
 - 4) Follow all instructions.
 - 5) Do not use this equipment near water.
 - 6) Clean only with dry cloth.
 - 7) Do not block any ventilation openings. Install in accordance with the manufacturer's instructions.
 - 8) Do not install near any heat sources such as radiators, heat registers, stoves, or other equipment (including amplifiers) that produce heat.
 - 9) Do not defeat the safety purpose of the polarized or grounding-type plug. A polarized plug has two blades with one wider than the other. A grounding type plug has two blades and a third grounding prong. The wide blade or the third prong are provided for your safety. If the provided plug does not fit into your outlet, consult an electrician for replacement of the obsolete outlet.
 - 10) Protect power cords from being walked on or pinched particularly at plugs, convenience receptacles, and the point where they exit from the equipment.
 - 11) Only use attachments/accessories specified by the manufacturer.
 - 12) For products that are not rack-mountable: Use only with a cart, stand, tripod, bracket, or table specified by the manufacturer, or sold with the equipment. When a cart is used, use caution when moving the cart/equipment combination to avoid injury from tip-over.
 - 13) Unplug this equipment during lightning storms or when unused for long periods of time.
 - 14) Refer all servicing to qualified service personnel. Servicing is required when the equipment has been damaged in any way, such as power-supply cord or plug is damaged, liquid has been spilled or objects have fallen into the equipment, the equipment has been exposed to rain or moisture, does not operate normally, or has been dropped.
 - 15) For products that are a Mains powered device:
The equipment shall not be exposed to dripping or splashing and no objects filled with liquids (such as vases) shall be placed on the equipment.
- Warning!** To reduce the risk of fire or electric shock, do not expose this equipment to rain or moisture.
- 16) For products containing a lithium battery:
CAUTION! Danger of explosion if battery is incorrectly replaced. Replace only with the same or equivalent type.
 - 17) The equipment shall be used at a maximum ambient temperature of 40° C.



Avid
2001 Junipero Serra Boulevard
Daly City, CA 94014-3886 USA

Technical Support (USA)
Visit the Online Support Center at
www.avid.com/support

Product Information
For company and product information
visit us on the web at www.avid.com