

# ALLEN & HEATH

**ZED SIXTY-10FX & ZED SIXTY-14FX**

## **USER GUIDE**



Publication AP8765

# CONTENTS

Warranty.....	4
Conformity Statement.....	5
Safety Instructions.....	6
Packed Items Checklist.....	9
Introduction to ZED Sixty-10FX & 14FX.....	10
Specifications.....	12
Dimensions.....	13
Block Diagram.....	14
Mono Input Channel 1&2 (10FX) 1-6 (14FX).....	15
Mono Input Channel 3&4 (10FX) 7&8 (14FX).....	18
Stereo Input Channel 1.....	19
Stereo Input Channel 2.....	21
ZED-FX Digital Effects Processor.....	22
Master Section.....	24
USB Connection.....	26
Connection Drawing—Live Mixing.....	27
Connection Drawing—Studio Recording.....	28
Connecting to Pro Tools (Mac).....	29
Connecting to Pro Tools (Windows).....	30
Sound Mixing Tips for First Time Users.....	31
Wiring Information.....	33
Product Support.....	34

# WARRANTY

## Limited One Year Warranty

This product is warranted to be free from defects in materials or workmanship for period of one year from the date of purchase by the original owner.

To ensure a high level of performance and reliability for which this equipment has been designed and manufactured, read this User Guide before operating. In the event of a failure, notify and return the defective unit to ALLEN & HEATH Limited or its authorised agent as soon as possible for repair under warranty subject to the following conditions

### **Conditions Of Warranty**

The equipment has been installed and operated in accordance with the instructions in this User Guide.

The equipment has not been subject to misuse either intended or accidental, neglect, or alteration other than as described in the User Guide or Service Manual, or approved by ALLEN & HEATH.

Any necessary adjustment, alteration or repair has been carried out by ALLEN & HEATH or its authorised agent.

The defective unit is to be returned carriage prepaid to ALLEN & HEATH or its authorised agent with proof of purchase.

Units returned should be packed to avoid transit damage.

In certain territories the terms may vary.

Check with your ALLEN & HEATH agent for any additional warranty which may apply.

<http://www.allen-heath.com>

## EMC & SAFETY

This product complies with the European Electro magnetic Compatibility directives 2004/108/EC and the European Low Voltage Directives 2006/95/EC.

This product has been tested to EN55103 Parts 1 & 2 2009 for use in Environments E1, E2, E3, and E4 to demonstrate compliance with the protection requirements in the European EMC directive 2004/108/EC. During some tests the specified performance figures of the product were affected. This is considered permissible and the product has been passed as acceptable for its intended use. Allen & Heath has a strict policy of ensuring all products are tested to the latest safety and EMC standards. Customers requiring more information about EMC and safety issues can contact Allen & Heath.

NOTE: Any changes or modifications to the console not approved by Allen & Heath could void the compliance of the console and therefore the users authority to operate it.

ZED Sixty-10FX & 14FX User Guide AP8765 Issue 2

Copyright © 2012 Allen & Heath Limited. All rights reserved

Allen & Heath Limited

Kernick Industrial Estate, Penryn, Cornwall, TR10 9LU, UK

<http://www.allen-heath.com>

# SAFETY INSTRUCTIONS

**WARNING - Read the following before proceeding :**



**ATTENTION: RISQUE DE CHOC ELECTRIQUE – NE PAS OUVRIR**



**WARNING: This equipment must be earthed.**

**Read instructions:**

Retain these safety and operating instructions for future reference. Adhere to all warnings printed here and on the console. Follow the operating instructions printed in this User Guide.

**Do not remove cover:**

Operate the console with its covers correctly fitted.

**Power sources:**

Connect the console to a mains power unit only of the type described in this User Guide and marked on the rear panel. Use the power cord with sealed mains plug appropriate for your local mains supply as provided with the console. If the provided plug does not fit into your outlet consult your service agent for assistance.

**Power cord routing:**

Route the power cord so that it is not likely to be walked on, stretched or pinched by items placed upon or against it.

**Grounding:**

Do not defeat the grounding and polarisation means of the power cord plug. Do not remove or tamper with the ground connection in the power cord.

# SAFETY INSTRUCTIONS

- Water and moisture:** To reduce the risk of fire or electric shock do not expose the console to rain or moisture or use it in damp or wet conditions. Do not place containers of liquids on it which might spill into any openings.
- Ventilation:** Do not obstruct the ventilation slots or position the console where the air flow required for ventilation is impeded. If the console is to be operated in a rack unit or flightcase ensure that it is constructed to allow adequate ventilation.
- Heat and vibration:** Do not locate the console in a place subject to excessive heat or direct sunlight as this could be a fire hazard. Locate the console away from any equipment which produces heat or causes excessive vibration.
- Servicing:** Switch off the equipment and unplug the power cord immediately if it is exposed to moisture, spilled liquid, objects fallen into the openings, the power cord or plug become damaged, during lightening storms, or if smoke, odour or noise is noticed. Refer servicing to qualified technical personnel only.
- Installation:** Install the console in accordance with the instructions printed in this User Guide. Do not connect the output of power amplifiers directly to the console. Use audio connectors and plugs only for their intended purpose.

## Important Mains plug wiring instructions

The console is supplied with a moulded mains plug fitted to the AC mains power lead. Follow the instructions below if the mains plug has to be replaced. The wires in the mains lead are coloured in accordance with the following code:

TERMINAL		WIRE COLOUR	
		European	USA/Canada
<b>L</b>	LIVE	BROWN	BLACK
<b>N</b>	NEUTRAL	BLUE	WHITE
<b>E</b>	EARTH GND	GREEN & YELLOW	GREEN

The wire which is coloured Green and Yellow must be connected to the terminal in the plug which is marked with the letter E or with the Earth symbol. This appliance must be earthed. The wire which is coloured Blue must be connected to the terminal in the plug which is marked with the letter N.

The wire which is coloured Brown must be connected to the terminal in the plug which is marked with the letter L.

Ensure that these colour codes are followed carefully in the event of the plug being changed.

# SAFETY INSTRUCTIONS

## General Precautions:

**Damage :** To prevent damage to the controls and cosmetics avoid placing heavy objects on the control surface, scratching the surface with sharp objects, or rough handling and vibration.

**Environment :** Protect from excessive dirt, dust, heat and vibration when operating and storing. Avoid tobacco ash, smoke, drinks spillage, and exposure to rain and moisture. If the console becomes wet, switch off and remove mains power immediately. Allow to dry out thoroughly before using again.

**Cleaning :** Avoid the use of chemicals, abrasives or solvents. The control panel is best cleaned with a soft brush and dry lint-free cloth. The faders, switches and potentiometers are lubricated for life. The use of electrical lubricants on these parts is not recommended. The fader and potentiometer knobs may be removed for cleaning with a warm soapy solution. Rinse and allow to dry fully before refitting them.

**Transporting :** Protect the controls from damage during transit. Use adequate packing if you need to ship the unit.

### Hearing :



To avoid damage to your hearing do not operate any sound system at excessively high volume. This applies particularly to close-to-ear monitoring such as headphones and in-ear systems. Continued exposure to high volume sound can cause frequency selective or wide range hearing loss.

# PACKED ITEMS

Check that you have received the following:

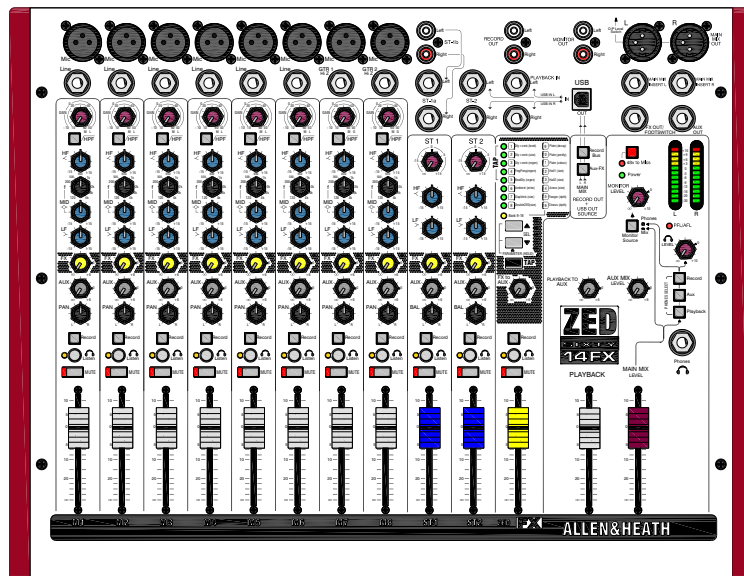
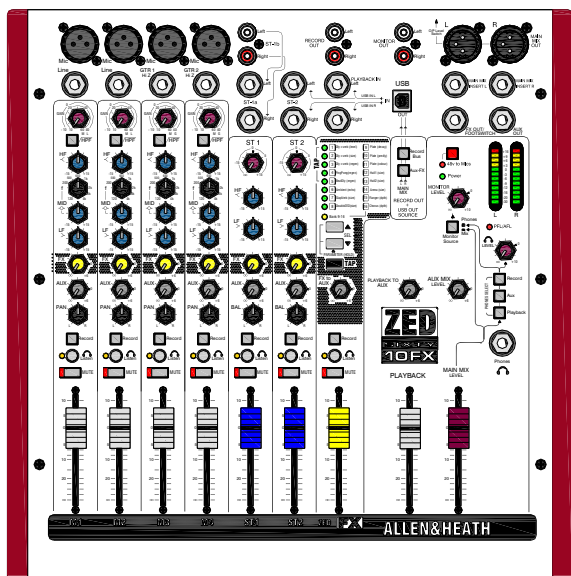

ZED Sixty-10FX MIXER

or ZED Sixty-14FX MIXER

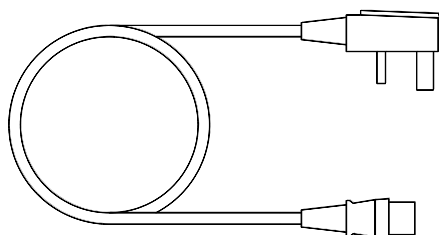

Mains Lead

Check that the correct mains plug is fitted.



This User Guide!



# INTRODUCTION TO THE ZED Sixty

## **Background Overview:**

The Allen & Heath ZED series mixers have been carefully and lovingly designed in the beautiful county of Cornwall in the UK and are manufactured alongside a wide range of professional audio mixing consoles to the same high standards. Many of the components used in ZED Sixty-10FX and ZED Sixty-14FX are exactly the same as in the larger Allen & Heath products and the construction methods are also very similar — utilising individual vertically mounted channel circuit boards with each rotary control fixed with a metal nut to the front panel. This provides a very robust product that will resist damage and give years of reliable use. It also makes servicing much easier should it be required, with the ability to remove one particular channel from the mixer at a time. The vertical board construction method is unique in a product at this price point and puts the ZED Sixty-10FX and ZED Sixty-14FX in a truly professional class of their own.

The audio circuitry is based on years of continual development and refinement, the performance of all the elements within the mixer is scrutinised and perfected to ensure the very best sound quality possible.

## **Multi-application:**

ZED's are great for live mixing! Their layout makes them very easy to use and easy to achieve a great sound. They are also perfect for recording, either a live show or an audio project at home can be built up track by track using the USB digital audio interface. The flexibility and quality of these mixers make them stand out from the crowd. You can plug your guitars or instruments straight into the class A discrete FET high impedance inputs, cater for up to eight microphones, two stereo sources with MP3 player compatibility, separate 2-track record outputs and a stereo playback input for 2-track replay or perhaps interval music from a CD player, XLR main stereo outputs with inserts, comprehensive monitoring with headphones and separate monitor speaker outputs, 48V microphone phantom power, DI level switching for sub mixing, and not least of all, the same digital effects algorithms as those used on our flagship digital consoles costing 150 times as much!

All this and the ability to withstand life being gigged night after night—there is nothing else like it at this price point.

ZED mixers are also ideal for teaching establishments, houses of worship, hotels and conference centres where their ease of use and robust qualities make them a top choice.

## **Mic/Line Pre-amps:**

Based on the pre-amps from the MixWizard series, the ZED Sixty pre-amps use low noise discrete transistor circuitry to achieve high gain (60dB max), low noise and good linearity.

## **GTR/Hi Z Inputs:**

Specially designed, two ultra high impedance discrete class A FET (Field Effect Transistor) inputs for plugging any kind of guitar or instrument straight in. A 26dB gain boost switch allows instruments with very low output pickups to be used, and the FET does a great job of emulating the valve/tube input circuitry commonly found on instrument combos or amplifiers.

# INTRODUCTION TO THE ZED Sixty

## **EQ:**

The ZED Sixty mixers are equipped with a 3-band equaliser circuit on each mono input, with swept mid frequency section, and a 2-band EQ on the stereo channels. The frequency and response of each has been carefully chosen to give the maximum performance when using the EQ on a variety of sources.

## **Record Bus:**

A separately switched stereo bus can be routed to from any channel creating a selective recording bus, monitoring bus or stereo clean feed output. You can even route just the effects processor output to this bus and use the mixer as a high end effects unit.

## **Effects Processor:**

Zed Sixty mixers have a professional quality effects processor built in which uses our own effects algorithms developed by our talented engineering staff at Allen & Heath. The effects range from classic reverbs, cascaded delay plus reverbs to shimmering flanger & chorus effects. The different effects types are selected with a simple up/down button interface and the tempo of the delay settings can be set using the TAP button. Holding the TAP button allows the parameters of the effects to be adjusted. The audio signal to the DSP is converted using 24 bit high dynamic range converters running at 48kHz sample rate, ensuring low noise, low distortion, transparent effects.

## **USB:**

Getting audio to and from a computer easily is now a common requirement for live sound and music production. The way we have implemented this on ZED is super-flexible and super-easy! No longer do you need to fiddle around the back of your computer to get to the soundcard inputs, only to find that the levels are all wrong and noisy. Just plug in a USB lead to your ZED, select the USB routing on the mixer and the device on your computer and that's it! CD quality audio to and from your PC or MAC.

## **Internal power supply:**

Not a "wall wart" - a proper built in power supply specifically designed and based on totally reliable technology.

# SPECIFICATIONS

## Operating Levels

Input	
Mono channel (XLR) Input	-10 to -60dBu for nominal (+11dBu in max)
Mono channel Line Input (Jack socket)	+10 to -40dBu (+31dBu maximum)
Stereo Input (Jack or phono sockets)	0dBu nominal (control = Off to +15dB)
Output	
L/R Outputs (XLR) Normal/DI out	0dBu/-30dBu +21dBu/-9dBu maximum.
Aux & FX Outputs (Jack sockets)	0dBu nominal. +21dBu maximum.
Record & Monitor Outputs (phono sockets)	0dBu nominal. +21dBu maximum.

## Frequency Response

Mic in to Mix L/R Out, 30dB gain	+0.5/-1dB 10Hz to 30kHz.
Line in to Mix L/R out 0dB gain	+0.5/-1dB 10Hz to 25kHz
Stereo in to Mix L/R out	+0.5/-1dB 10Hz to 30kHz

## THD+n

Mic in to Mix L/R Out, 10dB gain 1kHz +10dBu out	0.002%
Mic in to Mix L/R Out, 30dB gain 1kHz	0.01%
Line in to Mix L/R out 0dB gain 0dBu 1kHz	0.003%
Stereo in to Mix L/R out 0dB gain +10dBu 1kHz	0.002%
Gtr Input to Mix L/R Out, 0dBu, Boost OUT	0.015%
Gtr Input to Mix L/R Out, 0dBu, Boost IN	2% Second Harmonic

## Headroom

Analogue Headroom from nominal (0Vu)	21dB
USB in & out headroom from nominal (0Vu)	14dB

## Noise

Mic Pre EIN @ max gain 150R input Z 22-22kHz	-127dBu
Mix L/R out, L/R faders = 0, Levels min, 22-22kHz	-96dBu (10FX)
Mix L/R out, L/R faders = 0, Levels min, 22-22kHz	-93dBu (14FX)

## USB Audio CODEC (Coder/Decoder)

USB Audio In/Out	USB I.1 compliant 16bit.
Sample Rate	32, 44.1, or 48kHz

# DIMENSIONS

ZED Sixty-10FX

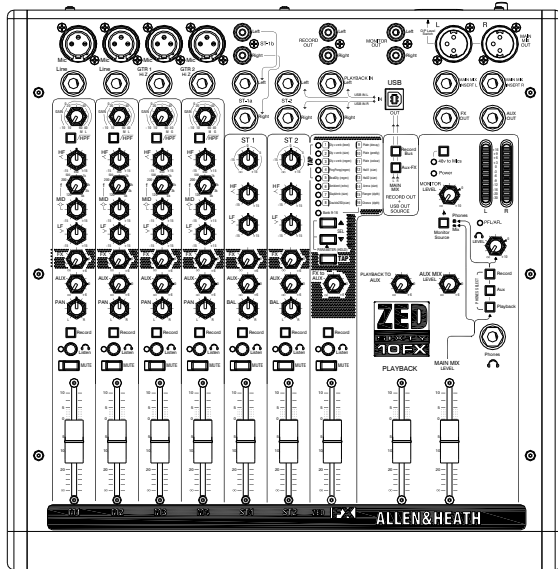

ZED Sixty-14FX

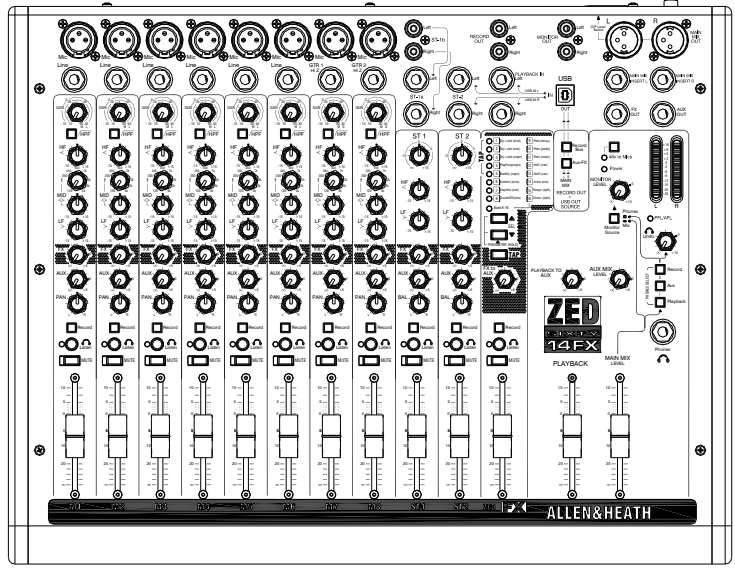

336mm (13.2 inches)

440mm (17.3 inches)

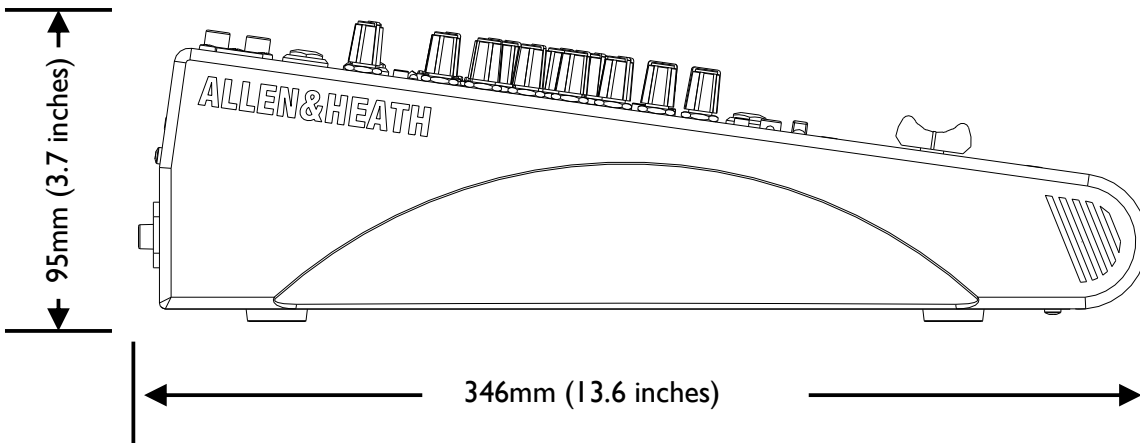

	Weight	
	ZED Sixty-10FX	ZED Sixty-14FX
Unpacked	3.8kg (8.4 lb)	6.2kg (13.6 lb)
Packed	4.4kg (9.7 lb)	6.8kg (15 lb)

# BLOCK DIAGRAM SCHEMATIC

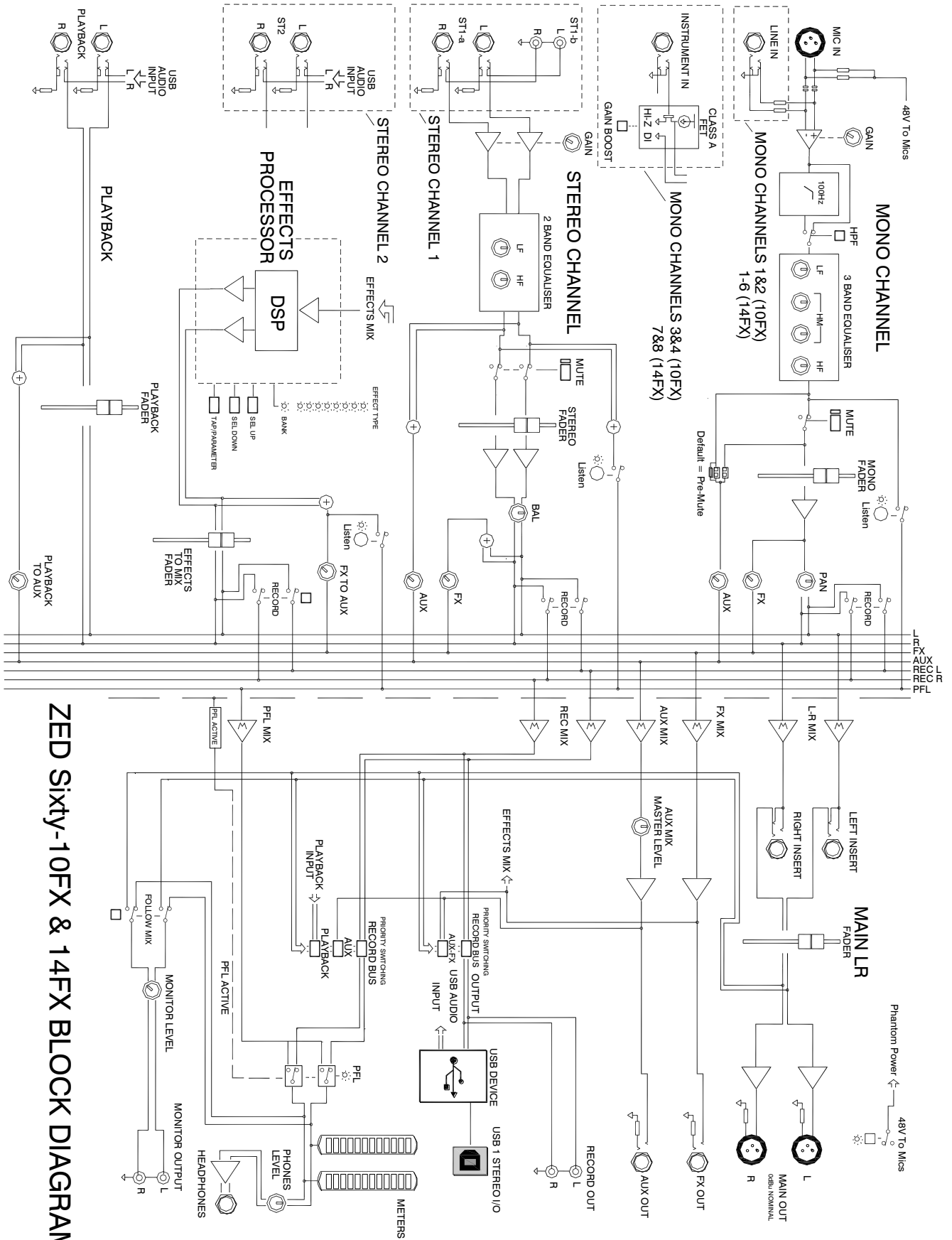

ZED Sixty-10FX & 14FX BLOCK DIAGRAM

# MONO INPUT CHANNEL 1&2 (10FX) 1-6 (14FX)

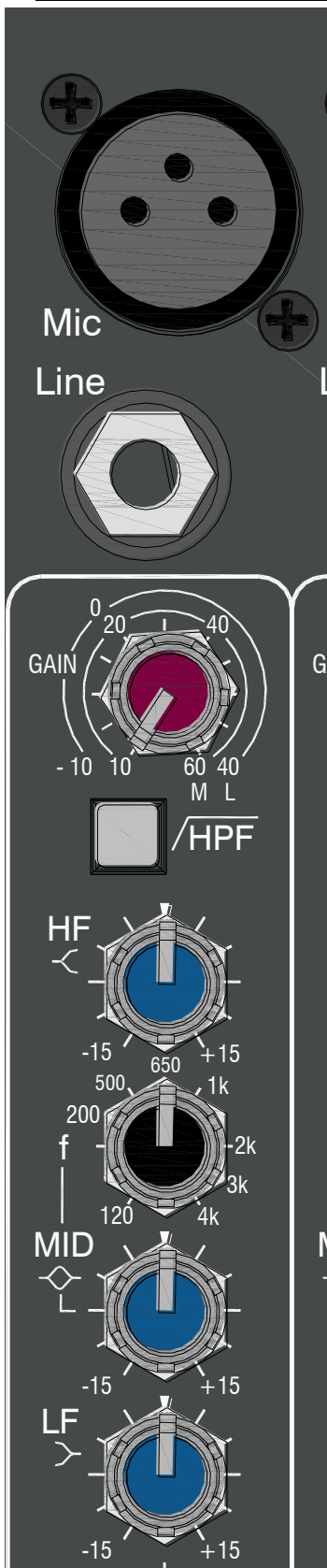

### Mic Input Socket

Standard 3-Pin XLR socket wired as Pin 1=Chassis, Pin 2=hot (+), Pin 3=Cold (-).

### Line Input Jack Socket

Standard 1/4" (6.25mm) Jack socket for balanced or unbalanced line level signals. Wired Tip=Hot(+), Ring=cold (-), Sleeve=Chassis.

The Line input connects to the XLR input through a circuit, so be aware that the two signals will add together if both inputs are plugged in simultaneously.

### Gain Control

This adjusts the gain of the input amplifier to match the signal level of the source. The gain is varied from +10dB to +60dB for signals plugged in to the xlr socket (Mic Input) and -10dB to +40dB for signals plugged into the Line input jack.

### 100Hz Hi-pass Filter

The Hi-pass filter is used for reducing pop noise and rumble from microphone signals. It is a single pole (6dB per octave) filter with a corner frequency set at 100Hz.

The filter affects signals from both Mic XLR and Line jack socket.

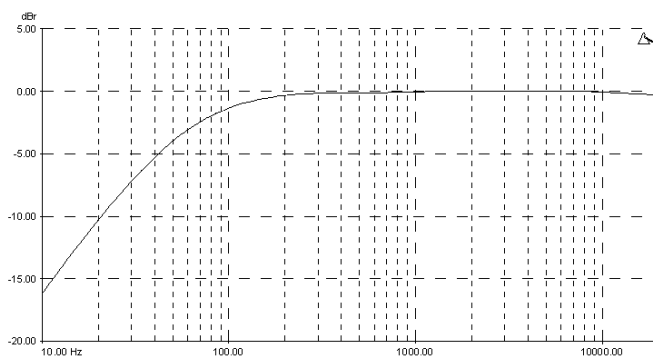

# MONO INPUT CHANNEL 1&2 (10FX) 1-6 (14FX)

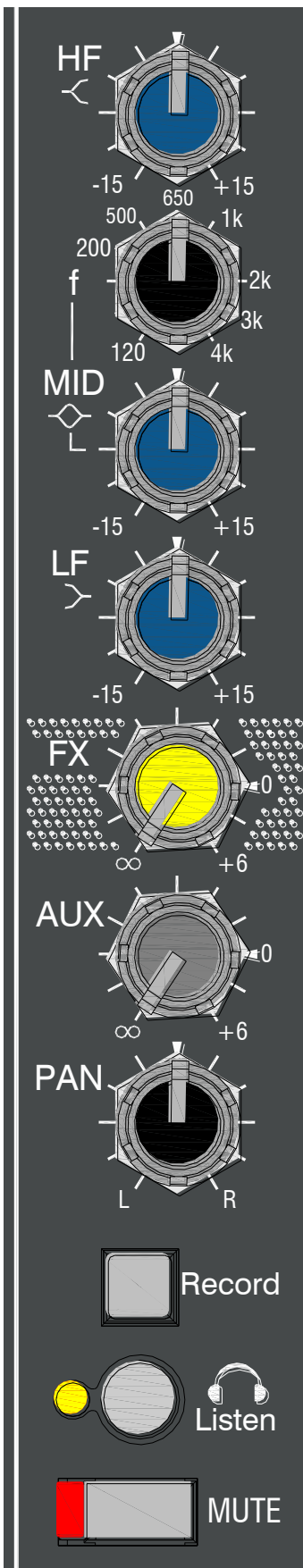

## HF EQ

The HF (High Frequency) equaliser affects the frequency response of the higher audible frequencies. The corner frequency of 12kHz is around 3dB from the maximum cut or boost of the circuit. It has plenty of gain and actually gives slightly more than the +/-15dB legend suggests.

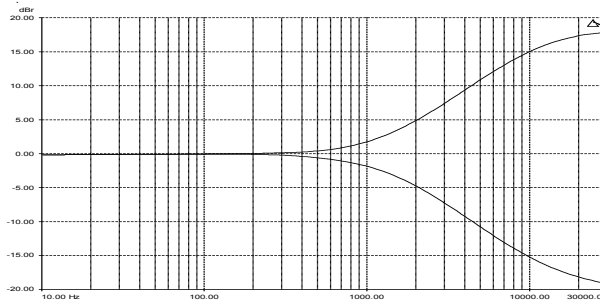

## MF EQ

The MF (Mid Frequency) equaliser affects the middle of the audible frequency range. The frequency graduations on the sweep control are the centre frequencies of the EQ. The range has been carefully chosen to cover “boomy” frequencies around 120Hz to 250Hz which may need cutting back, or a lift at 2 to 3kHz may be required for microphone intelligibility.

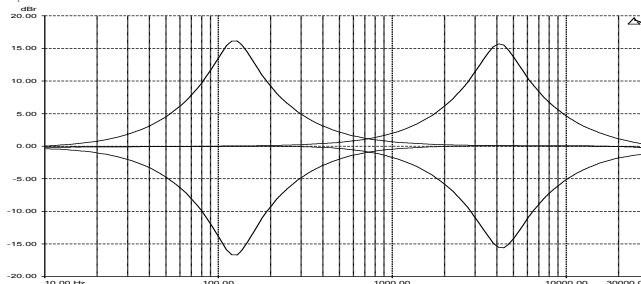

## LF EQ

The LF (Low Frequency) equaliser affects the response at the low end of the audio range. The graph shows the response of the LF EQ at maximum cut and boost. The corner frequency is 80Hz.

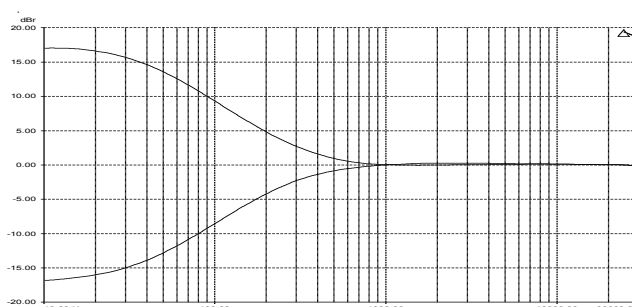

# MONO INPUT CHANNEL 1&2 (10FX) 1-6 (14FX)



## FX send

This controls the level of signal that is sent to the effects bus and FX output from the channel. The signal is post-fade which means it is affected by the channel fader (so it stays in proportion to the signal going to Mix) and the send control has 6dB gain fully clockwise.

There is no master level control for the FX bus.

## AUX send

Controls the level of signal sent to the Auxiliary output from the channel. The signal is sourced pre-fade so is independent of the level being sent to the main L-R Mix. The send control has +6dB gain fully clockwise and unlike the FX bus, there is a master level control for the Aux output.

## PAN

The pan control adjusts how the signal from the mono input channel is shared between the left and right stereo buses and subsequently the main stereo outputs. Set to the mid position, equal amounts of signal are fed to left and right, with pan set to L, none is sent to the Right bus.

## Record

Switches the channel signal to a separate stereo bus called Record. The Pan and Level controls affect the Record signal and the channel Mix L-R signal remains unaffected by this switch.

## Listen

Switches the channel signal to the headphones or monitor output circuit for checking the channel signal. Takes the signal after the EQ but before the fader (so you can check the signal before adding it to Mix or Record)

## Mute

Cuts the signal to the main left/right outputs, effects bus and record bus. By default the Aux send is not affected by muting the channel.

## Fader

A 60mm fader controls the amount of signal sent to the main left/right outputs, effects bus and record bus. The fader has 10dB of gain at the top of its travel.



# MONO INPUT CHANNEL 3&4 (10FX) 7&8 (14FX)



## Hi Z input

The only difference between these mono inputs is the Hi Z inputs for guitars or other instruments.

Standard 1/4" (6.25mm) Jack socket for unbalanced line level signals or instrument pickups. Wired Tip=Hot(+), Ring=cold (-), Sleeve=Chassis.

The Hi Z input connects to the XLR input through a circuit, so be aware that the two signals will add together if both inputs are plugged in simultaneously.

The Hi Z input can be used with normal line level signals but is designed specifically to match signals from instrument pickups. The input impedance is extremely high (10Mohms) and a FET (Field Effect Transistor) running in Class A mode emulates the type of circuits used in valve guitar combos or head amplifiers. The input circuit has soft asymmetric overdrive characteristics, giving a warm 2nd harmonic character to the sound if required.

Hi Z Input **GAIN BOOST OUT**

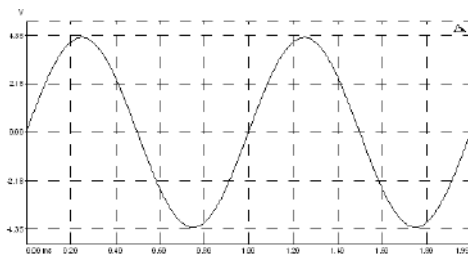

Hi Z Input **GAIN BOOST IN**

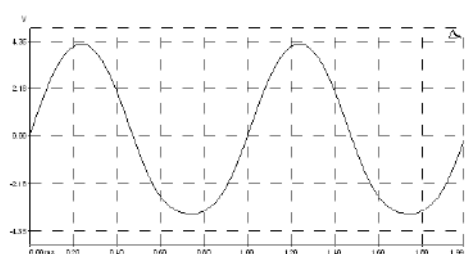

## Gain Boost

A recessed switch on the rear panel allows the HI Z input to be boosted by 26dB, useful for instruments with weak pickups or where more overdrive is required. When the XLR is being used or for normal line level signals (like keyboards)—make sure the switch is in the OUT position.

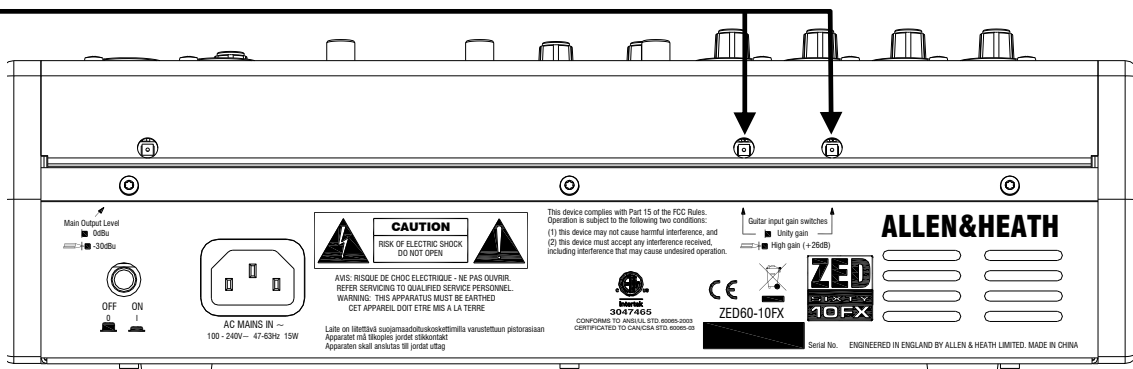

# STEREO INPUT CHANNEL I

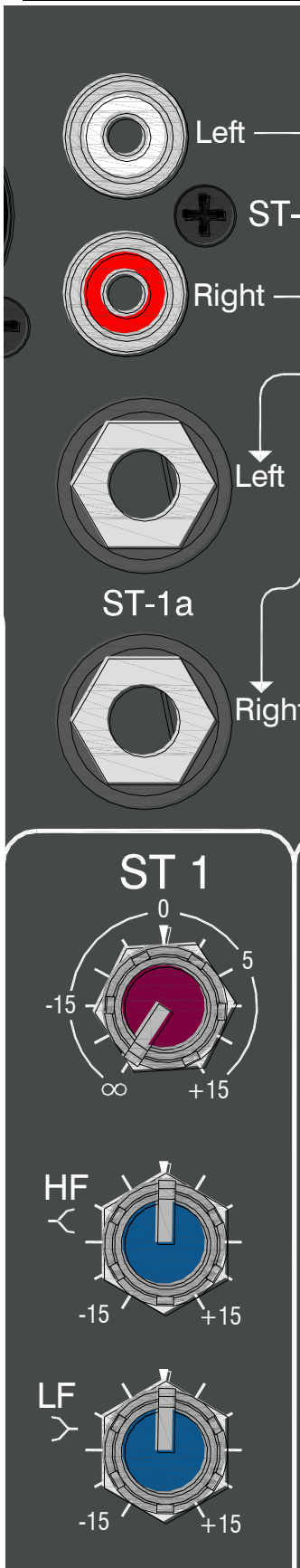

## ST-1b Inputs

Standard RCA Phono sockets for unbalanced line level stereo signal sources from equipment such as CD players, sound modules or MP3 players. If your MP3 player has a mini jack socket (most common) use a stereo mini jack plug to 2 x RCA Phono lead.

## ST-1a Inputs

Standard 1/4" jack sockets for line level stereo signals. The ST1b inputs (RCA Phono) are connected through the break contacts of these jack sockets so plugging into ST1a will override the signals from ST1b.

## ST-1 Gain

Adjusts the input level to the ST1 channel from off (maximum attenuation) to +15dB gain. For low level inputs from MP3 players, turn it fully clockwise.

## Stereo EQ

High frequency and low frequency equaliser with corner frequencies of 12kHz for the HF and 80Hz for the LF and maximum cut & boost of 15dB.

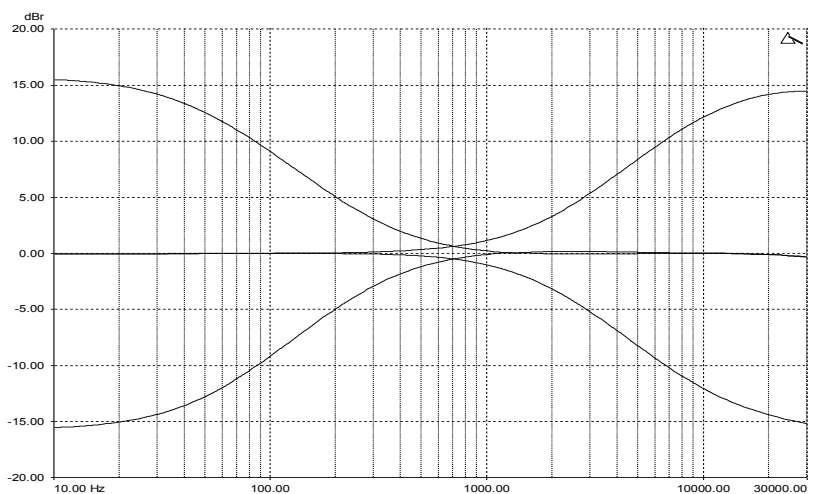

Stereo channel EQ

# STEREO INPUT CHANNEL I

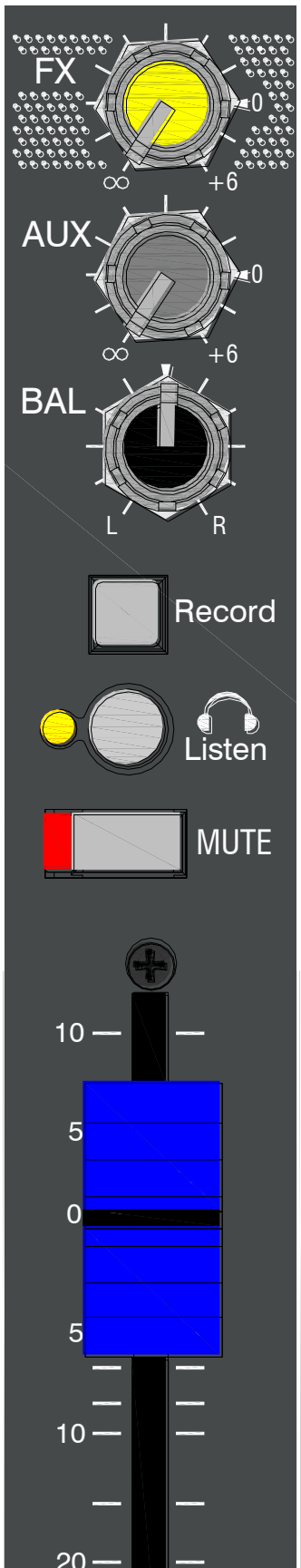

## FX send

This controls the level of signal that is sent to the effects bus and FX output from the stereo channel. The signal is post-fade which means it is affected by the channel fader (so it stays in proportion to the signal going to Mix) and the send control has 6dB gain fully clockwise.

There is no master level control for the FX bus.

## AUX send

Controls the level of signal sent to the Auxiliary output from the stereo channel. The signal is sourced pre-fade so is independent of the level being sent to the main L-R Mix. The send control has +6dB gain fully clockwise and unlike the FX bus, there is a master level control for the Aux output.

## Balance

The balance control adjusts the relative level between the left and right stereo signals as they are sent to the stereo buses and subsequently the main stereo outputs. Set to the mid position, equal amounts of signal are fed to left and right, with Bal set to L, none is sent to the Right bus.

## Record

Switches the channel signal to a separate stereo bus called Record. The Bal and fader affect the Record signal and the channel Mix L-R signal remains unaffected by this switch.

## Listen

Switches the channel signal to the headphones or monitor output circuit for checking the channel signal. Takes the signal after the EQ but before the fader (so you can check the signal before adding it to Mix or Record)

## Mute

Cuts the signal to the main left/right outputs, effects bus and record bus. By default the Aux send is not affected by muting the channel.

## Fader

A 60mm fader controls the amount of signal sent to the main left/right outputs, effects bus and record bus. The fader has 10dB of gain at the top of its travel.

# STEREO INPUT CHANNEL 2

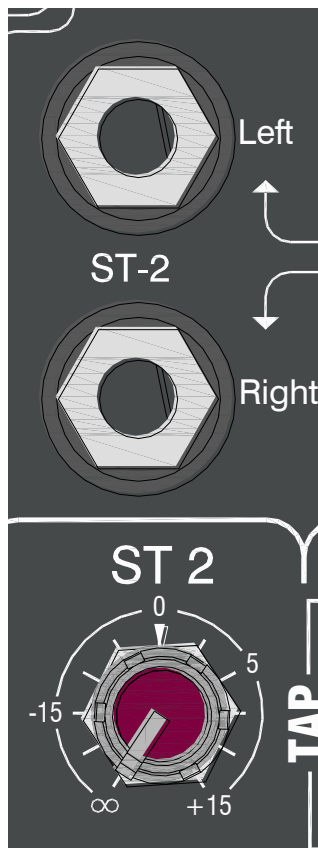

## ST-2 Input

The USB audio input is connected through the break contacts of the standard 1/4" (6.25mm) jack sockets. Plugging into the jacks will override the USB input, so if you want to use the ST-2 channel for the USB input signal, make sure nothing is plugged into the jack sockets.

The rest of the features of the ST-2 channel are as described for ST-1



## Important Note:

If the ST-2 channel is not being used for USB playback or stereo input it is best to keep the level controls turned down so that unwanted noise from the inactive USB device is not passed to the mix.

## Record OUT

Standard RCA phono sockets for the stereo line level Record outputs sourced from the USB out selector switches. Useful for connecting to stereo recording devices, stereo mix feeds, or where selective channels are required to feed other equipment.

## Playback Input

Standard 1/4" (6.25mm) jack sockets for unbalanced line level inputs. Can be used for additional stereo sources such as CD players for background music, or playing back a final mix from a recording device. The USB audio input is connected through the break contacts of these inputs, plugging into the jack sockets overrides the USB input.

## USB OUT Source selector switches

Select the signal source for the USB audio output and the Record output. With both switches up the main Mix is selected. The Record Bus switch will override the Aux-FX switch if both are pressed.

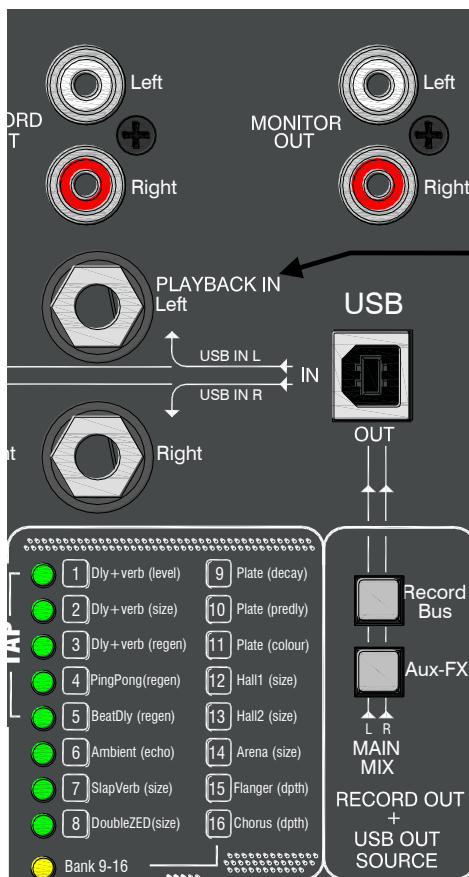

# ZED-FX EFFECTS PROCESSOR



## Effects Type Selection LED.

8 Green LED's show one of 16 effects types available. If the Bank LED is off the green LED's will show one of 1 to 8 on the effects list (or off if no LED's are lit), if the Bank LED is on the green LED's will show which of effects types 9 to 16 is selected. For effects types 1 to 5, the green LED will blink in time with the tempo of the delay time.

The green LED's also display the level of the parameter adjustment when the TAP button is held down. The more LED's that illuminate, the more the parameter is increased in value or intensity.

## Bank LED.

The Bank LED illuminates when one of the effects type 9 to 16 is selected. If the Bank LED is on, then the green LED will show which effect is selected from the list.

## SEL Buttons.

The SEL buttons select the type of effect. They also adjust the parameter of the selected effect when the TAP button is held down.

## TAP Button.

The TAP button is used in two ways. If one of effects types 1 to 5 are selected then the TAP button can be used for adjusting the frequency or tempo of the delay parameter.

If the TAP button is held down, the SEL buttons then become parameter adjust buttons to increase or decrease the level of the parameter assigned to the selected effect.

## FX to AUX Send control.

This adds some of the effect to the Aux bus, so if the Aux is being used for a monitor for a singer for example, the performer will be able to hear their voice with some reverb added.

## Record

Switches the Effects (wet) signal to the stereo Record bus.

## Listen

Switches the Effects (wet) signal to the headphones or monitor output circuit for checking the effect.

## Mute

Cuts the effects return from the main Mix, Aux and Record buses.

## Effects Return fader.

Controls the volume of the effects (wet) signal to the main stereo Mix and the Record bus.

# ZED-FX EFFECTS PROCESSOR

## Effects Type List & Description.

There are 16 different effects presets in the ZED Effects Processor. Each is fed with a mono signal from the FX bus, and the output from the effects processor is in stereo.

Each preset has a parameter adjust control which is matched to the preset. This control may morph several parameters all at once, for example the parameter control for the Chorus effect will adjust not only the depth, but the response of the filters in software to create a more or less intense effect. In general, when adjusting the effect parameter, the more LED's that are illuminated, the more intense the effect or higher the parameter value.

To restore the parameter settings to the factory defaults, hold down both SEL buttons whilst switching on the power to your ZED.

## Effects Type Table with description.

Effect	Preset Name	Effect Description & Parameter adjustment.
1	Dly+verb(level)	Delay with Reverb. Delay feeds reverb (Classic Plate). TAP for delay time Min = 70mS Max = 1.35S, Adjust the level of reverb.
2	Dly+verb(size)	Delay with Reverb. Delay feeds reverb (Classic Plate). TAP for delay time Min = Min = 70mS Max = 1.35S, PARAMETER Adjusts the size of reverb.
3	Dly+verb(regen)	Delay with Reverb. Delay feeds reverb (Classic Plate). TAP for delay time Min = 70mS Max = 1.35S, PARAMETER adjusts the regeneration of the delay.
4	PingPong(regen)	Ping Pong delay (left then right) in parallel with Plate reverb. TAP for left delay time Min = 70mS Max = 1.35S, PARAMETER adjusts the delay regeneration.
5	BeatDly(regen)	As (4) but right delay is set for 1/4 beat of left. Good for off beat 4/4 delay sound. TAP for left delay time & PARAMETER adjusts the delay regeneration.
6	Ambient(echo)	Echo Delay with Reverb. PARAMETER adjusts the echo time.
7	SlapVerb(size)	Reverb with echo reflections creating classic slapback reverb sound. PARAMETER adjusts the slapback size (more slap echo).
8	DoubleZED(size)	Classic stereo doubler. PARAMETER adjusts delay and size.
9	Plate(decay)	Classic plate reverb. PARAMETER adjusts decay time.
10	Plate(predly)	Plate reverb with pre-delay. Good for vocals/percussion. PARAMETER adjusts pre-delay time (for increased intelligibility).
11	Plate(colour)	Classic plate reverb. PARAMETER adjusts tonal texture from dark to bright.
12	Hall1(size)	Smooth classic hall reverb. PARAMETER adjusts size of hall.
13	Hall2(size)	Brighter hall reverb. PARAMETER adjusts size of hall.
14	Arena(size)	Arena reverb. PARAMETER adjusts size of arena.
15	Flanger(dpth)	Classic flanger effect. PARAMETER adjusts depth and tonality.
16	Chorus(dpth)	Chorus effect. PARAMETER adjusts depth and tonality.

# MASTER SECTION

## Main Mix Out XLR connectors

Standard XLR output connectors for the main stereo mix. Impedance balanced to aid interference rejection. A recessed switch on the rear panel reduces the level by 30dB if it is required to submix these outputs into the XLR inputs of another mixer.

## Main Mix Insert jack sockets

Standard 1/4" (6.25mm) jack sockets wired: Tip = send, Ring = return, Sleeve = Chassis. Nominal level is 0dBu.

## Effects & Aux bus Outputs

Standard 1/4" (6.25mm) jack sockets wired: Tip=hot, Ring=cold, Sleeve=Chassis. 0dBu. The FX out is the Effects bus output, and can be used for connecting to external equipment such as an effects processor. OR a latching footswitch can be connected (wired between Tip & Sleeve) and used to mute the on-board FX. The AUX out is taken from after the AUX MIX master level control.

## 48v to Microphones

Switches industry standard 48v (phantom power) to all 4 microphone inputs for use with condenser microphones.

## Monitor Level

Controls the volume of the stereo monitor outputs from off (fully attenuated) to +10dB of gain.

## Monitor Source switch

This allows the stereo monitor outputs (RCA phonos) to be sourced either from the headphone monitor selection, or from the main stereo mix. Useful for splitting the functions of the stereo monitor outputs from the headphones.

## Aux Mix Level control

The master volume control for the Aux mix bus. Adjusts the level from off (fully attenuated) to +6dB gain.

## Main Mix Fader

This is the master level control for the main stereo mix. The fader has 10dB of gain at the top.

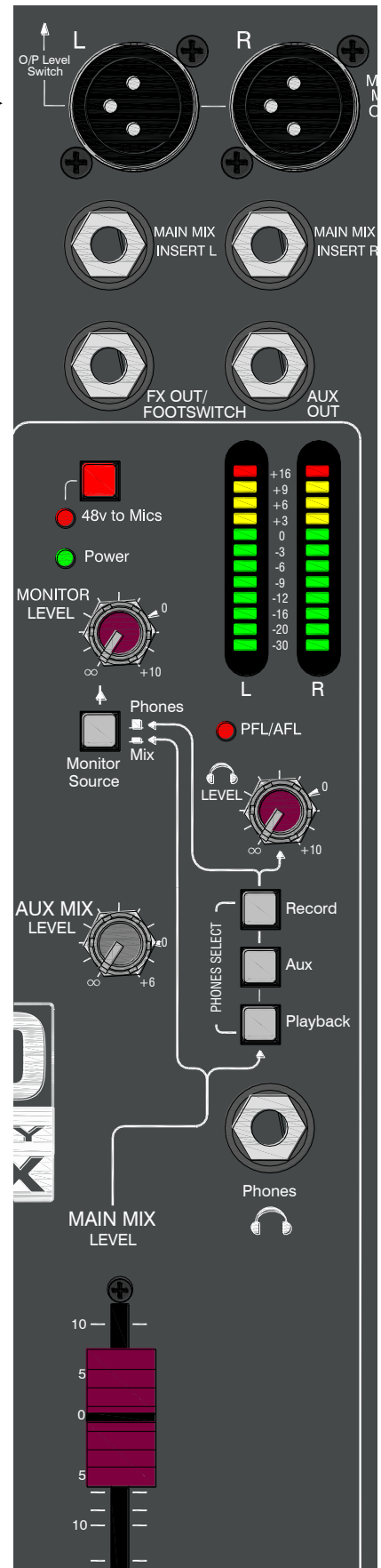

# MASTER SECTION

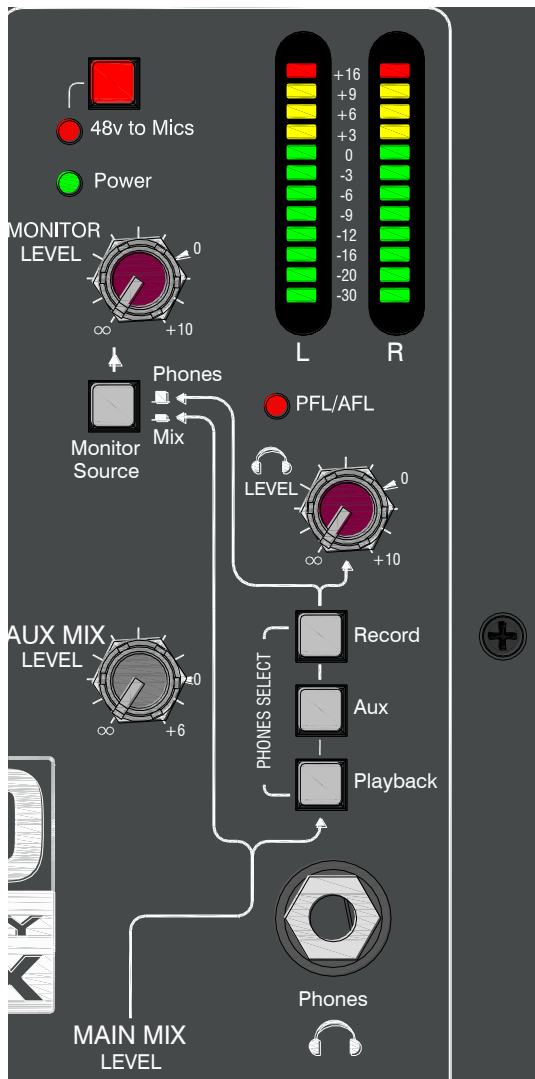

## Stereo Meters

12 Segment LED meters with fast attack (4mSec) and medium decay (1Sec).

The meters display the signals selected by the Phones Select switches, or the mono Listen signal (PFL) if activated by any of the Listen switches.

## PFL (Pre-Fade Listen) active LED

A red LED to indicate a Listen switch has been pressed on one of the channels.

Doing this will override the Phones select source to the headphones and send the Listen signal to the meters.

## Headphones level

Controls the volume of signal to the headphones.

**Warning !** To avoid damage to your hearing do not operate the headphones or sound system at excessively high volume. Continued exposure to high volume sound can cause frequency selective or wide range hearing loss.

## Phones Source Selector switches

These switches allow you to choose what you hear on the headphones. With all switches up the default is the main stereo Mix, then you can choose between the Playback input (USB Input if nothing is plugged into the jacks), the Aux bus output, or the Record bus output. Pressing any Listen switch will override the selection and allow you to monitor individual channels.

## Headphones Output

Standard 1/4" (6.25mm) jack socket wired Tip=Left, Ring=Right, Sleeve=Ground.



# CONNECTING TO A COMPUTER

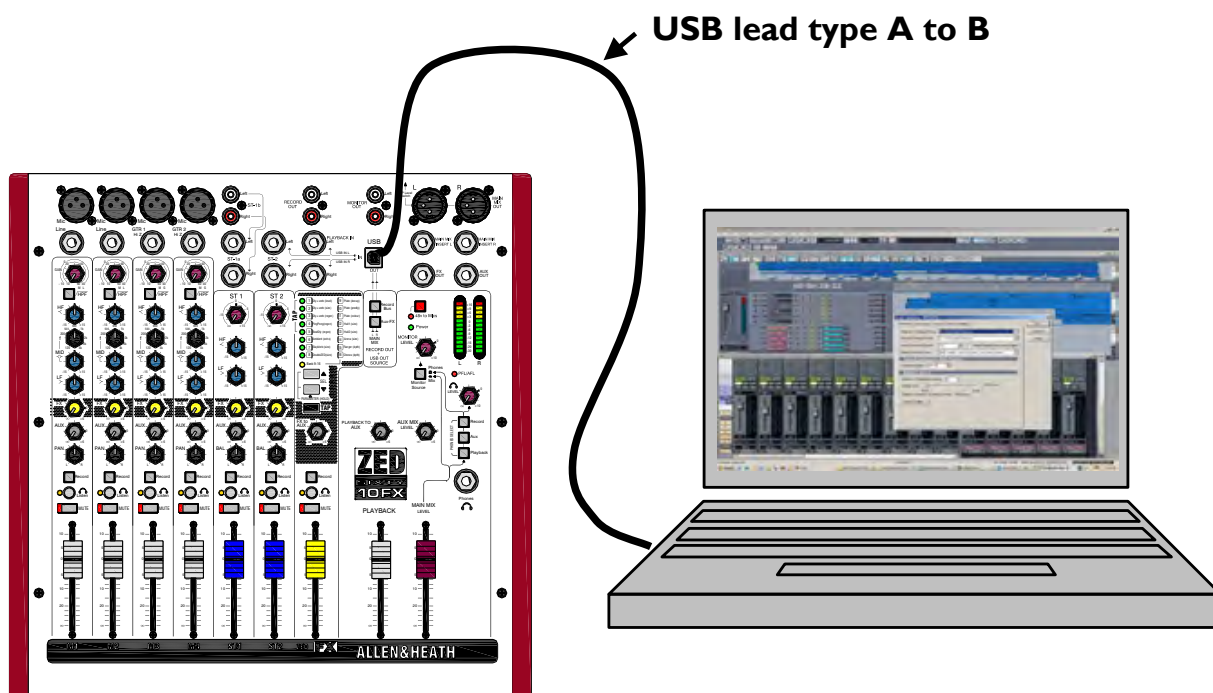

## USB Audio Interface

The ZED is equipped with a stereo bi-directional USB I.I compliant audio CODEC. It is fully compliant with USB 2 ports and uses standard Windows and MAC Core Audio Drivers. In other words, plug it in and your computer will find it and be able to transfer audio to and from the ZED USB device.

You will need some form of audio software running on your computer to be able to record and play back what you record, but on a basic level, you can use your computers media player to play straight to the ZED device.

Just a couple of points to look out for:

**Windows XP/Vista:** When you plug in your ZED USB interface to your computer, if the volume level is low or inaudible, check the device volume in control panel/Sounds and Audio Devices/Volume. Set the volume to High.

**Windows 7:** At present, Windows 7 treats the USB audio device as a microphone source instead if a line input, so set the device volume level much lower, we found setting to 3 is ideal.

# CONNECTION DRAWING—LIVE MIXING

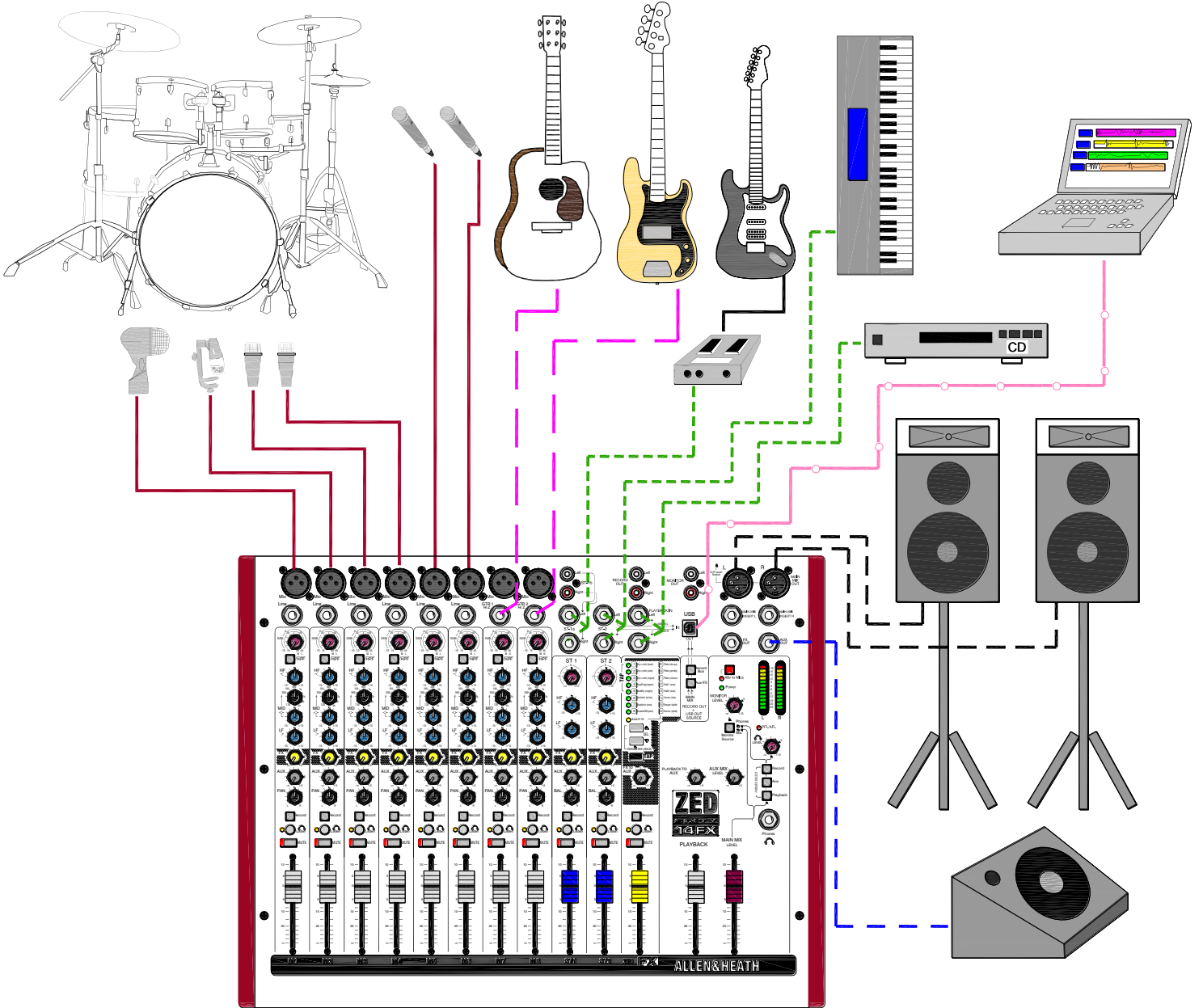

- KEY:**
- - 
  - 
  - 
  - 
  -
- MICROPHONE SIGNAL
TO POWERED STAGE MONITOR
- FROM INSTRUMENT
USB CONNECTION
- LINE LEVEL SIGNALS
TO POWERED PA SPEAKERS

# CONNECTION DRAWING—STUDIO RECORDING

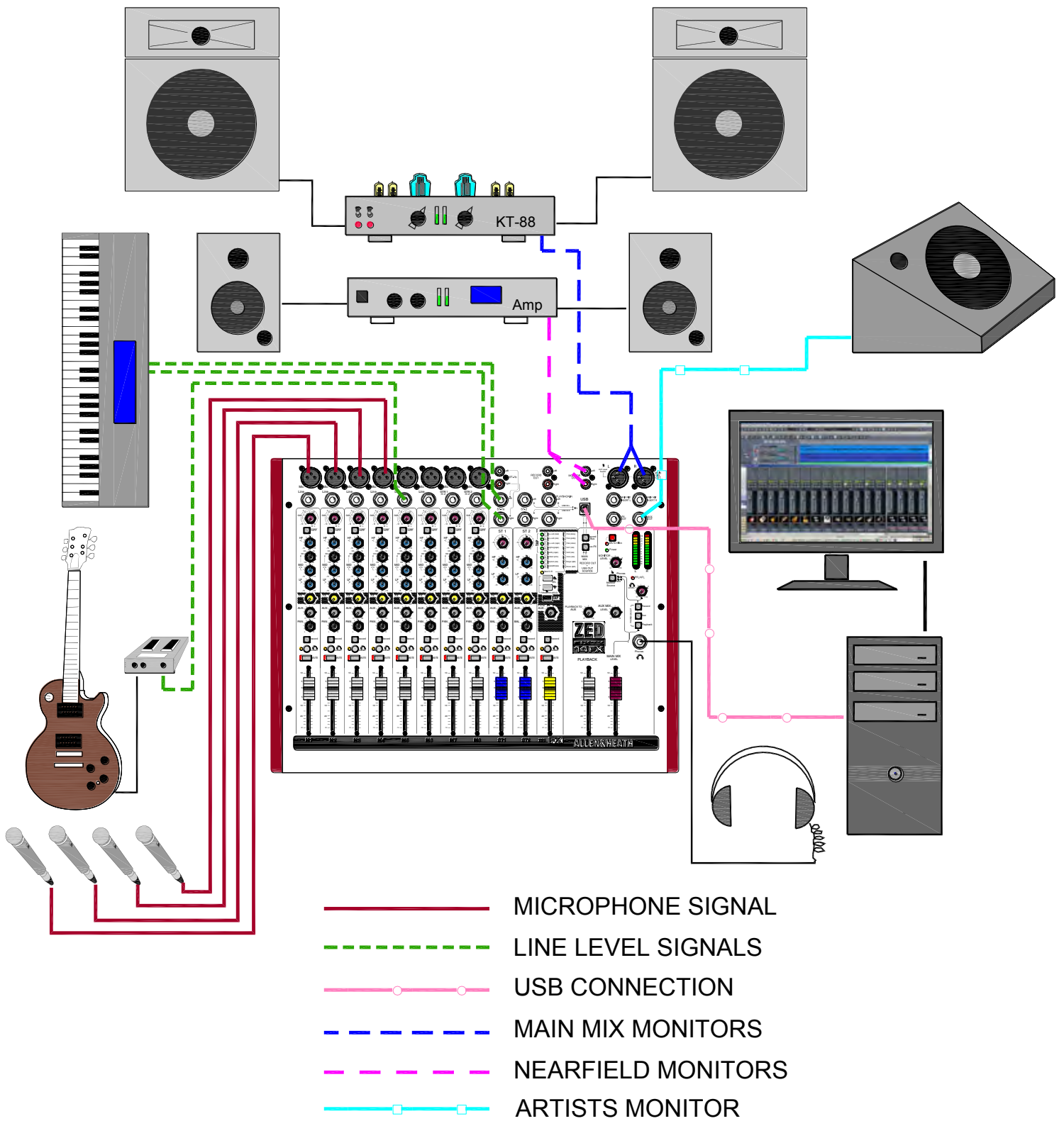

# CONNECTING A ZED TO PRO TOOLS 9(& UP) ON A MAC

1. Connect your ZED mixer to your Mac via USB and power on the mixer.
2. With Pro Tools (PT) installed, open Audio MIDI Setup on your Mac. PT should have created a Pro Tools Aggregate I/O folder in the Audio Devices list. The ZED interface should appear as USB Audio CODEC in the list along with other audio devices in your system. Tick Use to enable the device in PT.



Audio MIDI Setup...

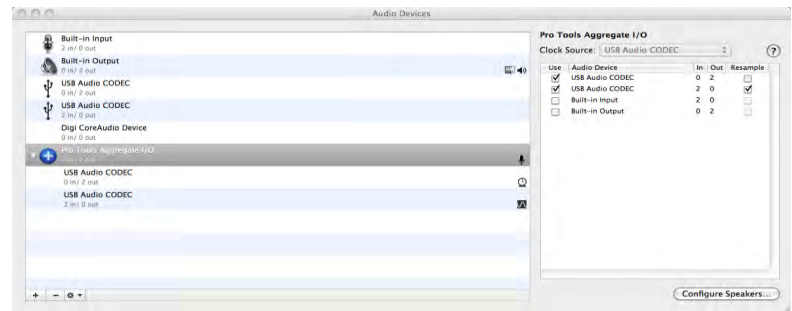

3. Run Pro Tools and create a new session with at least two audio tracks. Open the SETUP/Playback Engine window and select Pro Tools Aggregate I/O as the Current Engine. Click OK.
4. In PT click SETUP and then I/O. Select Output from the menu and the devices available should appear in a box labelled PTAI/O (Pro Tools Aggregate I/O). Here you can create a new output path if one doesn't exist, name it (here it's called ZED Stereo OUT) and tick it to enable.
5. In I/O Setup, click the Input tab. The input sources appear for enabled devices in Pro Tools Aggregate I/O. Create a new path for the inputs and name as you prefer. Note that mono channels can use one channel of a stereo input path. Make sure the path is ticked and click OK.

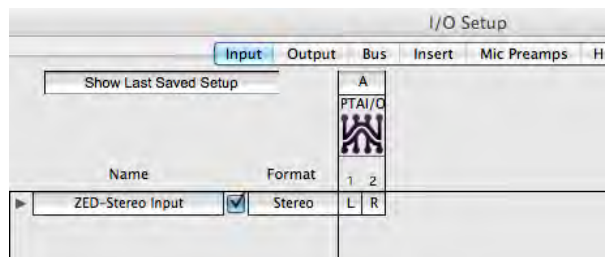
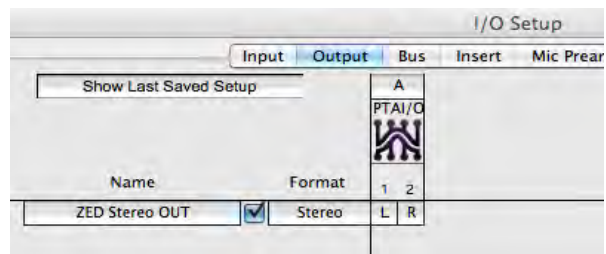
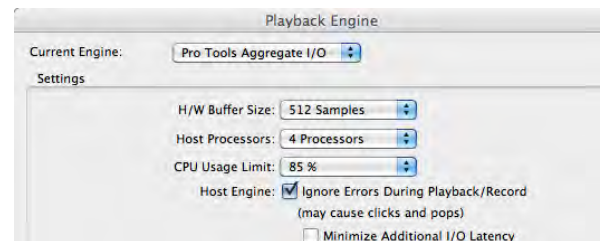

6. Select the inputs and outputs for your tracks in your session. Here the input for mono Track 1 is selected as the Left channel from the ZED USB interface. The track outputs can either be routed to the ZED directly or to a master bus in Pro Tools and then to the ZED. Be wary of possible feedback loops when setting the routing to the tracks and then back to the ZED.

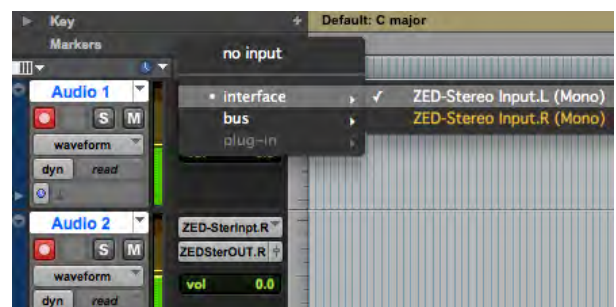

## CONNECTING A ZED TO PRO TOOLS 9(& UP) ON A WINDOWS PC

On a Windows system, Pro Tools 9 and (higher) support third party audio interfaces only in conjunction with ASIO drivers. **Pro Tools won't recognize WDM devices such as the standard USB Audio Codec used by the ZED mixers.** Since the ZED USB mixers have no dedicated ASIO driver, you will need a third party driver. We recommend using ASIO4ALL, a popular, hardware independent, low latency ASIO driver for WDM audio devices. ASIO4ALL is compatible with all Windows systems, it's free for the end user and is currently available for download here: [www.asio4all.com](http://www.asio4all.com)

- Download and install ASIO4ALL.
- Connect your ZED mixer to your PC via USB and power on the mixer.
- Run Pro Tools and create a new session. Choose a sample rate compatible with the ZED USB interface (44.1kHz or 48kHz) and select 16 Bit Depth.
- Open 'Setup / Playback Engine' and select ASIO4ALL v2 as the Current Engine, then click OK.
- Open 'Setup / Hardware' and click the 'Launch Setup App' button. The ASIO4ALL control panel is displayed. ASIO4ALL will default to the USB Audio CODEC any time a ZED mixer is connected to the computer. The device state shown by the small icons should be Active, as pictured.
- If needed, select the USB Audio CODEC and use the slider to adjust the ASIO buffer size. Smaller buffer size means lower latency. However, if you hear crackles or audio becomes distorted, you may need to increase the buffer size. **Please note any change in the driver settings is likely to require Pro Tools to restart.** Refer to the ASIO4ALL v2 Instruction Manual for a description of the advanced settings and troubleshooting of the driver.
- Close the ASIO4ALL control panel and click OK to close the Playback Engine window.
- Open 'Setup / IO' and click the Default button in the Input, Output and Bus tabs. This will discard your previous Pro Tools settings and create a 'USB Audio CODEC 1-2' Stereo Input, its mono sub-paths, and a 'USB Audio CODEC 1-2' Stereo Output. The Audition Paths and Default Output Bus will also default to 'USB Audio CODEC 1-2'.

Further information can be downloaded from the ZED pages at: [allen-heath.com](http://allen-heath.com)

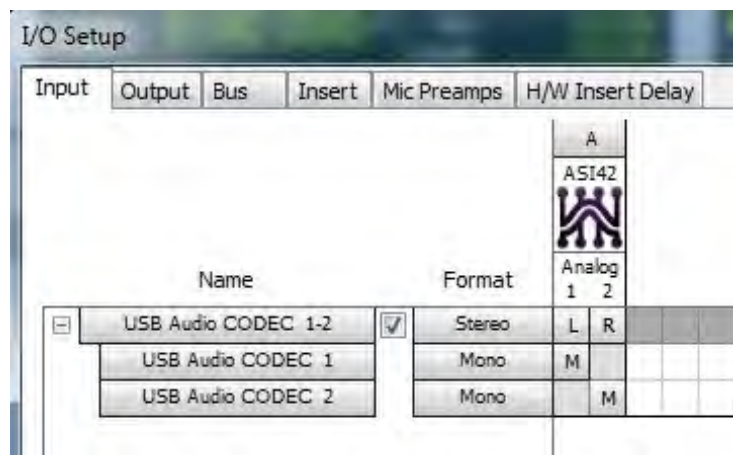
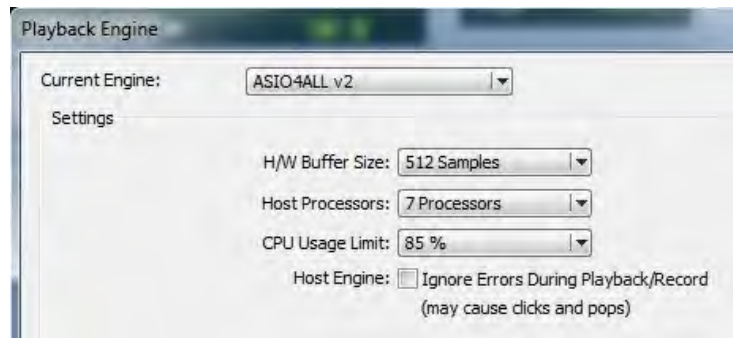

## SOUND MIXING TIPS FOR FIRST TIME USERS

### Step 1: Connect your Sources

- Plug in your microphones, instruments, audio players using the connection drawings on p27 & 28 as a rough guide.
- If condenser microphones are being used: Keep the faders down and channel mutes activated, switch on 48V to Mics.

### Step 2: Check the levels

- For each channel, individually in turn check the signal level by speaking or getting someone to speak into the microphone or play the instrument. Press the Listen button on the channel and adjust the channel Gain control so that the level on the meters illuminates up to the 0dB mark when audio is present. It is ok for the meters to show higher levels on loud peaks, but if the red LEDs illuminate, reduce the Gain slightly.
- De-select Listen when you are happy with the level and check the next channel in turn, repeating the procedure.
- Now is a good time to correct or enhance the tonal balance of the audio signal using the EQ. Ideally use it to reduce problem resonant frequencies to try to listen out for harsh sounds that may be resonating in the speakers or environment. It is sometimes useful to use the EQ with frequency sweep with boost first to hone in and highlight a possible problem frequency, then use the EQ to reduce or cut that frequency.

### Step 3: Create your stereo mix

- Set the Main Mix (red) fader to the 0dB position and check that none of the Phones Select switches are pressed.
- You will now need to listen to the audio by either headphones connected to the Phones output or through amplified speakers connected as shown in the drawings on p27 & 28.
- With audio active from the microphones and/or instruments, un-mute the channels and raise the channel faders to a position where the required volume is heard. If the volume is too loud when the fader is above the -10dB position on the scale, reduce the Phones level, or speaker amplifier volume controls.
- Raise all the channel faders required for the mix. The optimum position for the input channel fader is between 0 and -10 on the scale. When the input Gain is set correctly, this maintains good signal to noise ratio whilst allowing the operator to balance the channels to create the ideal mix.
- Use the Pan control on the mono channels and the Balance control on the stereo channels to set the left-right balance position of the audio signal in the stereo left-right mix.
- Adjust the position of the channel faders relative to each other to create the blend or mix that sounds best.

## SOUND MIXING TIPS FOR FIRST TIME USERS

### Step 4: Add Effects

- Reverb or echo effects can be used to add ambience and character to certain types of audio sources, particularly singers.
- Select the type of effect required using the FX section SEL buttons.
- Send some audio signal to the FX bus by turning the FX control clockwise on your preferred channel - try a vocal channel first.
- Gently raise the FX master fader (yellow) to add the effect to the main stereo mix.
- Be subtle when it comes to adding effects - too much will smother the original sound and keep the FX send controls turned down on other channels so they don't add to the mix.
- If you are using the AUX bus on your ZED to feed signal to a stage monitor (often called foldback) then it is possible to add some effects signal to this mix by using the FX to AUX control in the FX section.
- It is usual to mute effects used for singers when they stop singing and talk instead.
- The FX send control on the channel sends audio from after the fader so the amount will stay in relative proportion to the fader level. In other words, you don't need to turn the FX send control down when you reduce the fader, it follows automatically.

### Step 5: Using the AUX bus for feeding a stage monitor

- The Auxiliary bus can be used to create an independent mono mix of audio signals.
- There are many uses for Aux buses, but a common one is for artists monitors.
- Connect the AUX Out to an amplified monitor speaker which can be positioned close to the performers.
- Increase the AUX Mix level (master) control by turning it clockwise.
- Create your monitor mix by turning up the AUX send level controls on the channels that you require in the monitor speaker. The AUX send level controls are sourced from before the channel fader so they will not be affected by it, therefore remaining independent of any movements made on the faders to balance the main stereo mix.

### Step 6: Control feedback

- Be aware that amplified signals from microphones are usually able to feed back to the microphone and will, if loud enough, cause a feedback loop with howls or whistles.
- Feedback loops can be controlled by careful placement and use of uni-directional microphones, placement of speakers and correct microphone technique which will reduce the need for increased gain or level in the system.

### Step 7: Interval music

- If your application is a performance where background music is required, you can connect an MP3 or CD player to the Playback input.
- Mute all channels (leaving the faders set) and then the background music can be sent to the main left-right mix by raising the Playback fader.

# WIRING INFORMATION

## Insert cable wiring

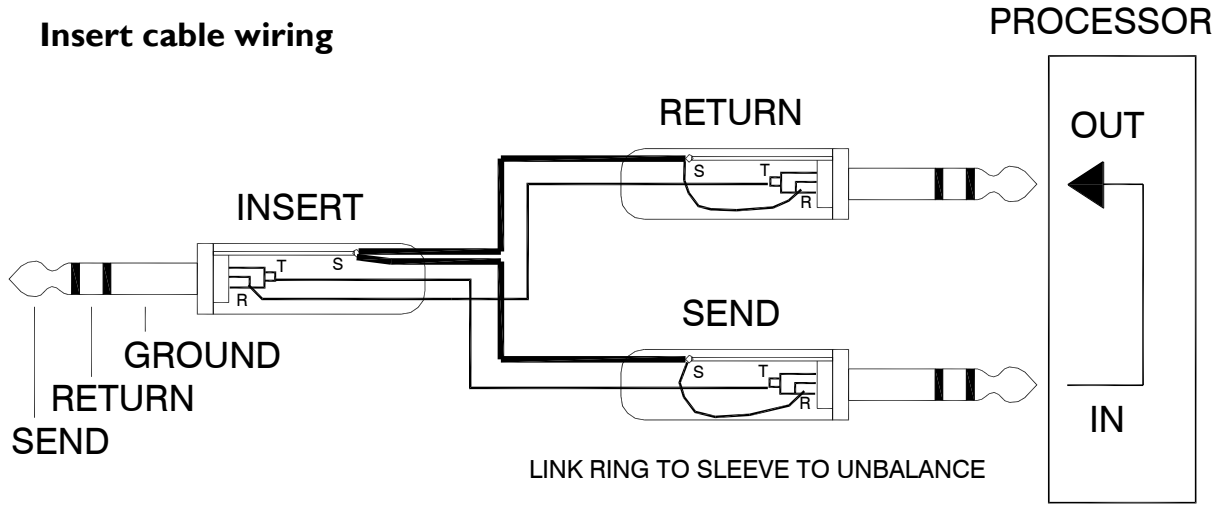

## General Wiring Information

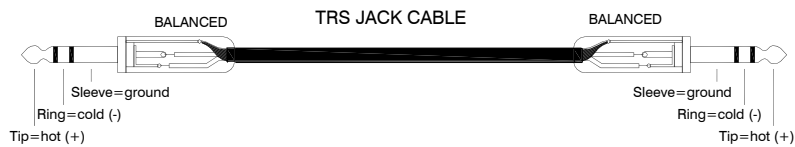
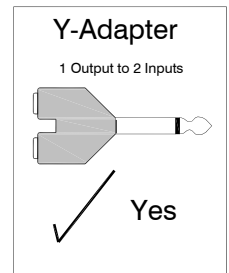
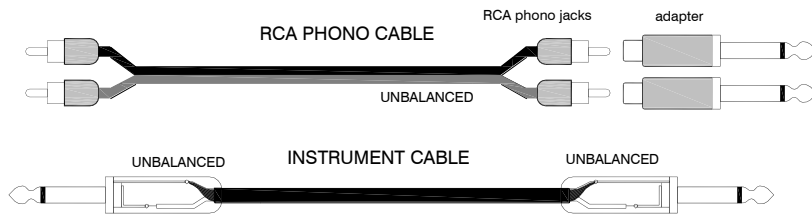
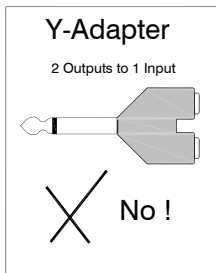

**TO INPUT**

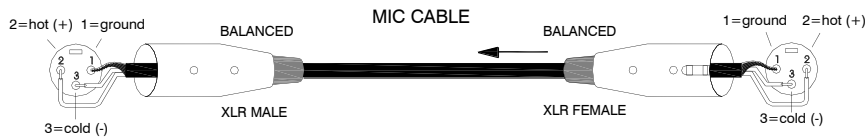

**FROM OUTPUT**

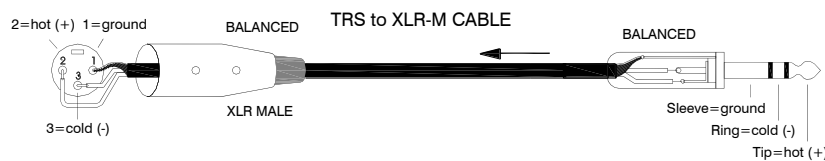
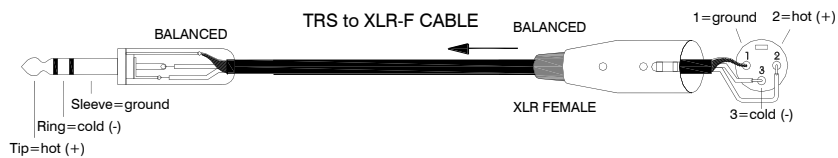



See more products from ALLEN & HEATH at: [www.allen-heath.com](http://www.allen-heath.com)



Large Live Sound mixers — iLive digital, and GL Series

Small Format Live Sound mixers — ZED, MixWizards and PA Series

DJ products — Xone Series

Sound Management Series — iDR Series

### Registering your product

Thank you for buying the Allen & Heath ZED Sixty mixer. We hope that you are happy with it and that you enjoy many years of faithful service with it.

Please go to [www.allen-heath.com/register.asp](http://www.allen-heath.com/register.asp) and register your product's serial number and your details. By registering with us and becoming an official Registered User, you will ensure that any warranty claim you might make is actioned quickly and with the minimum delay.

Alternatively, you may either copy or cut off this section of the page, fill in the details, and return it by mail to:

Allen & Heath Ltd, Kernick Industrial Estate, Penryn, Cornwall TR10 9LU, UK

<b>ALLEN&amp;HEATH PRODUCT REGISTRATION</b>	Thankyou for buying an Allen & Heath product. We hope that you're happy with it and that you enjoy many years of faithful service with it.
SERIAL NUMBER	
<b>Please return this section of the card by mail and retain the other part for your records. You can also register online at <a href="http://www.allen-heath.com">www.allen-heath.com</a>. Thanks for your help.</b>	
Your Name:	
Company Name:	
Address 1:	
Address 2:	
Town/City:	
Country:	
Telephone:	
Email:	
Why did you choose this console?	
Which other products did you you consider before choosing A&H?	
Is there any thing you would like to improve on this mixer?	
What audio magazines do you read?	
If you were going to design a mixer for your work, what are the 6 most important features it should have (in order of importance)	
1	2
3	4
5	6
We may use the information you provide to inform you of future product developments. We will not give or sell this data to third parties. Please indicate with an 'X' if you do not wish to receive any further communications from us. <input type="checkbox"/>	